

HANDBUCH / MANUAL / MANUEL

VDM18-100/20/122/151

VDM18-100/20/88/122/151

VDM18-300/20/122/151

VDM18-300/20/88/122/151

VDM18-300/21/122/151



Copyright (Deutsch)

Die Wiedergabe bzw. der Nachdruck dieses Dokuments, sowie die entsprechende Speicherung in Datenbanken und Abrufsystemen bzw. die Veröffentlichung, in jeglicher Form, auch auszugsweise, oder die Nachahmung der Abbildungen, Zeichnungen und Gestaltung ist nur auf Grundlage einer vorherigen, in schriftlicher Form vorliegenden Genehmigung seitens Pepperl+Fuchs GmbH, zulässig.

Für Druckfehler und Irrtümer, die bei der Erstellung der Betriebsanleitung unterlaufen sind, ist jede Haftung ausgeschlossen. Liefermöglichkeiten und technische Änderungen vorbehalten.

Erstveröffentlichung August 2004.

Copyright (Englisch)

No part of this document may be reproduced, published or stored in information retrieval systems or data bases in any manner whatsoever, nor may illustrations, drawings and the layout be copied without prior written permission from Pepperl+Fuchs GmbH.

We accept no responsibility for printing errors and mistakes which occurred in drafting this manual. Subject to delivery and technical alterations.

First publication August 2004

Copyright (Français)

Toute reproduction de ce document, ainsi que son enregistrement dans une base ou système de données ou sa publication, sous quelque forme que ce soit, même par extraits, ainsi que la contrefaçon des dessins et de la mise en page ne sont pas permises sans l'autorisation explicite et écrite de Pepperl+Fuchs GmbH.

Nous déclinons toute responsabilité concernant les fautes éventuelles d'impression et autres erreurs qui auraient pu intervenir lors du montage de cette brochure. Sous réserve de modifications techniques et de disponibilité pour livraison.

Première publication Août 2004



Maßzeichnung / Dimensional drawing / Plan coté



Abb. 1 / Illustr. 1 / Fig. 1

Anschluss / Wiring / Raccordement

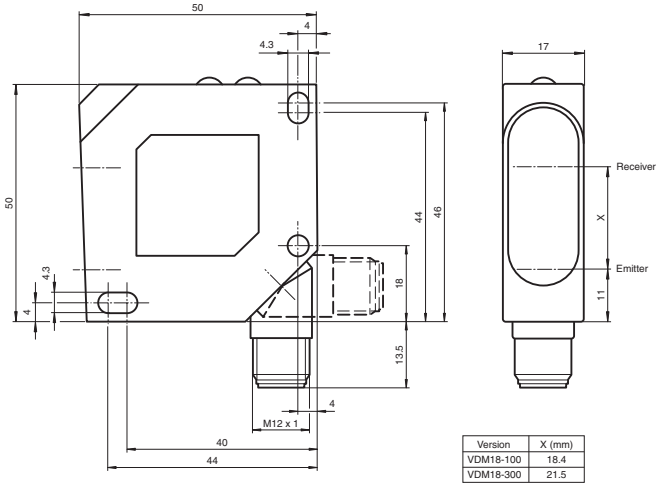
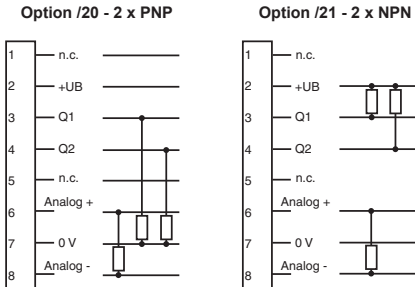

Typ / Type / Ref.	Pin 1	Pin 5
VDM18 .../88	RS485 Y/A	RS485 Z/B

Abb. 2 / Illustr. 2 / Fig. 2

Inhalt / Content / Contenu

Deutsch	5
English.....	26
Français.....	47



Content

Signs and Symbols.....	26
Safety information	26
Appropriate use	27
Performance characteristics	27
Mode of function	27
Mounting.....	28
Electrical installation	29
Instructions of use	30
General use	30
Settings.....	32
Functions	32
Reset	34
Unlocking keys	34
Averaging	35
Automatic zero mode.....	35
Automatic centre mode.....	36
Maximum hold mode	36
Difference hold mode	37
Measured value hold mode	37
Differential measurement mode	38
Transmission protocol	40
Bus commands.....	41
Explanations on bus commands.....	42
Optical data (typ.)	43
Electrical data (typ.).....	43
Mechanical data	43
Order information.....	44

Signs and Symbols



Warning

This symbol signals passages in the manual which must be observed at all times. Non-compliance can cause injuries or material damage.



Warning Laser

This symbol appears in front of warning passages concerning the danger of laser beams.



Information

This symbol signals passages with useful information.

Safety information



It is essential that this manual, and the safety information in particular, is read, thoroughly understood and observed before setting the VDM18 sensor into operation.

The VDM18 sensor may only be connected, mounted and adjusted by qualified personnel.

Interventions and alterations to the device are not permissible!

The VDM18 sensor is not a safety component as described by EU machine directives and must never be used in applications where human safety is at risk.



The VDM18 sensor complies with laser protection class 2 according to DIN EN 60825-1, status 2008-05. The technical requirements comply with EN 60947-5-2, 2000 edition.



Never look into the path of the laser. Do not suppress the reflex to close the eyelids. Gazing into the beam path for longer periods can damage the retina of the eye.

When mounting the sensor, ensure if possible that the beam path is sealed off at the end. The laser must not be directed at people (head height). When aligning VDM18, ensure that there are no reflections on reflective surfaces.

Should the safety label on the VDM18 sensor be partly covered due to its installation position, other safety labels are to be positioned on visible parts of the sensor. When applying the new safety label, make sure that you cannot look into the laser beam whilst reading it.



Appropriate use



The VDM18 sensor is not authorised for use in protecting human safety on machines and during technical applications.

The VDM18 is an optical sensor and measures distances without contact. When combined with another VDM18 sensor, the thickness of objects can also be measured.

Performance characteristics

- Operating range VDM18-100: 30 – 100 mm
- Operating range VDM18-300: 80 – 300 mm
- 2 digital outputs
- Analogue output 4-20 mA
- Compact design 50 x 50 x 17 mm
- High resolution (0.1 % of measuring range)
- Option /88 with serial bus interface (RS 485 half-duplex)
- “Teach-in” settings also possible per software
- Wide functional range

Mode of function

The VDM18 sensor measures according to the principle of triangulation. The distance between the object and sensor is determined on the basis of the position of the light spot on the detector.

Operating range (Factory setting)

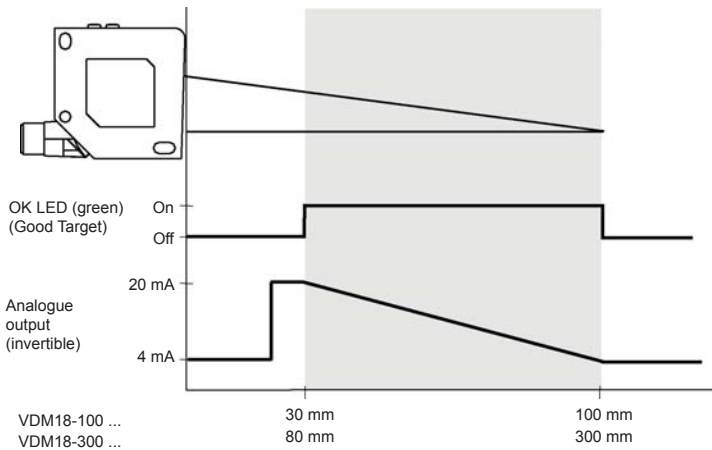

Illustr. 3

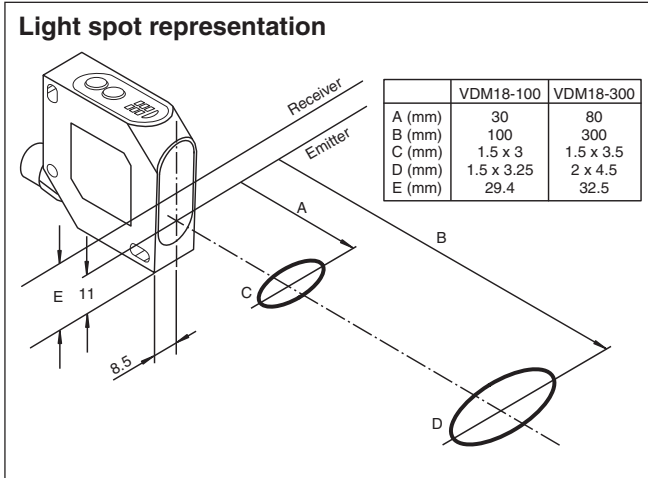

Illustr. 4

Mounting

Sensor alignment

Position VDM18 in a way that the distance to the object is within the working range of the sensor.

Screw the VDM18 sensor to the mounting bracket, e.g. type OMH-VDM18 (not included in delivery) or a suitable device. Only use the holes provided in the housing (see dimensioned drawing) for this purpose.

If steps, moving or striped objects are to be detected, the front panel of the sensor should be mounted at a right angle to the direction of movement or stripes (Illustr. 5 + 6).



With very reflective objects, the sensor must be mounted at an angle of approx. 5° (Illustr. 7).

To optimise measurements, the VDM18 sensor is to be given constructive protection from vibrations.

The VDM18 sensor is now mounted.

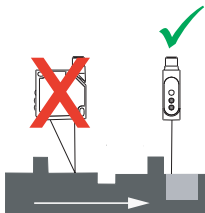

Illustr. 5 Linear movement

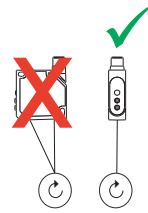

Illustr. 6 Rotating movement

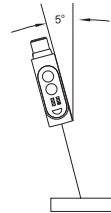

Illustr. 7 Reflective object



Electrical installation



Warning: Pin 1 and pin 5 must not be connected to operational voltage as this will destroy the VDM18 sensor.

Turn the sensor connector plug according to the installation position (Illustr. 1) so that the connection cable can be freely connected without being bent.

Insert the socket of the connection cable into the VDM18 connector and screw tight

For example, secure the connection cable from sliding with a cable tie .

Connect VDM18 as shown in Illustr. 8

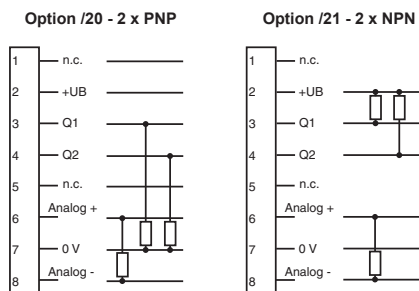

Type	Pin 1	Pin 5
VDM18 .../88	RS485 Y/A	RS485 Z/B

Illustr. 8 Connection diagram

Connection	Colour	Use	Comments
1 (WH)	White	RS485 Y/A	/88 option only
2 (BN)	Brown	+ U _B	
3 (GN)	Green	As signal output Q ₁ or input with optional input functions (see "Settings" page 32)	Q ₁
4 (YE)	Yellow	As signal output Q ₂ or switching function "good target" (detectable object in measuring range)	Q ₂ or good target
5 (GY)	Grey	RS 485 Z/B	/88 option only
6 (PK)	Pink	QA + analogue measurement	
7 (BU)	Blue	- U _B	
8 (RD)	Red	QA - analogue mass	

Once power supply has been connected, the VDM18 is ready for operation after a short stand-by delay (< 300 ms).



For maximum precision, please allow for a heating period (approx. 5 minutes).

Instructions of use

Control panel

The VDM18 has various modes and is configured using the S and T buttons.

Button

- S** Set button: Change / confirm a setting or set a switching point
- T** Toggle button: Select a function (proceed to the next function)

The selected settings and signal condition are indicated by LEDs.

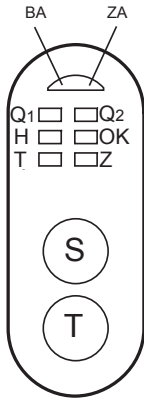

LED	Colour	Use/Description
BA	Green	Power supply indicator On: ready (run mode) Flashing: setting mode is active
ZA	Red	Status indicator Function activated/not activated, or confirmation signal
Q1	Yellow	Q1 input/output
Q2	Yellow	Q2 input/output
H	Green	Q1 trigger input or Q1 enable input function active
OK	Green	Good target (object detected and in measuring range)
T	Green	Pulse stretching function is active
Z	Green	Q1 automatic centre or Q1 automatic zero function is active

Illustr. 9

The table of functions on page 32 explains the further significance of the LEDs: Q1, Q2, H, OK, T and Z

General use

The following four steps are used to configure the VDM18 sensor:

1. Activate setting mode

Press the S and T buttons simultaneously for 3 seconds

After this period, the power supply indicator BA flashes

⇒ set VDM18, see Illustr. 9. The LEDs show the status of function no. 1 (page 32)

When all the LEDs start immediately flashing

⇒ Unlock VDM18, see paragraph "Unlocking keys" on page 34

2. Select functions (see page 32)

Press the T button to select the next function in the function table.

The function number is indicated by a clear LED pattern and the function status is indicated by the status indicator ZA (LED on = active, LED off = not active).



The sensor only switches to the next function when the T button is released.

If no change occurs:

- ⇒ Press T button for longer

The first function follows the last available function.



If the wrong function is selected by mistake, it is not possible to jump directly back to the previous function number.

- ⇒ Press the T button several times until the required function reappears.
- ⇒ Or deactivate setting mode (see point 4) and repeat procedure from step 1.

3. Setting the function status

Press the S button to alter the status of a particular function. The status indicator alters according to the table of functions. Settings are immediately effective but must still be saved as described in point 4.



Should the status indicator not alter or not light up whilst S is pressed

- ⇒ Check the position of the VDM18 sensor in relation to the measuring range and adapt if necessary

To reset the setting, press the S button once again (is not valid when transferring measured value as switching point!)

4. Deactivate setting mode

First press the T button and then simultaneously press the S button. All settings are then saved. Once the S button is released, the sensor is in run mode. The BA power supply indicator is permanently alight.



Should the power supply fail during the setting procedure, all settings are lost.

Settings

The VDM18 sensor can be configured as follows with functions 1 to 26 in setting mode (teach-in).



Button



Set button: Change / confirm a setting or set a switching point



Toggle button: Select a function (proceed to the next function)

Functions

No. LED Muster	Description	“ZA” status indicator	Factory setting
1 	Select Q ₁ output mode.	On = Q ₁ is a signal output Off = Q ₁ is not a signal output	On
2 	Transfer of current meas. value as 1 st switching point of Q ₁ signal output.	On* = Measured value valid Off* = Measured value invalid	Half measuring range
3 	Scanning zone: Transfer of current meas. value as 2 nd switching point of Q ₁ signal output. Q ₁ must be signal output (see function no 1).	On = Measured value valid Off = Measured value invalid	Off
4 	N.C./N.O. change-over of switching functions for Q ₁ .	On = N.C. Off = N.O.	N.O.
5 	Q ₂ output mode.	On = Q ₂ is a signal output Off = Q ₂ displays good target	Off
6 	Transfer of current meas. value as 1 st switching point of Q ₂ signal output. Q ₂ must be signal output (see function no 5)	On* = Measured value valid Off* = Measured value invalid	Good Target
7 	Scanning zone: Transfer of current meas. value as 2 nd switching point of Q ₂ signal output. Q ₂ must be signal output (see function no 5).	On = Measured value valid Off = Measured value invalid	Off
8 	N.C./N.O. change-over of switching functions for Q ₂ .	On = N.C. Off = N.O.	N.O.
9 	Pulse stretching of Q ₁ and Q ₂ by 50 ms.	On = Pulse stretching on Off = Pulse stretching off	Off
10 	Q ₂ signal output shows status “good target”. Switching signal can be inverted with function no 8.	On = Object within... Off = Object outside... ...measuring range	On

* as long as the S button is pressed



Mounting and operating instructions

No. LED Muster	Description	“ZA” status indicator	Factory setting
11 Q ₁ <input checked="" type="checkbox"/> <input checked="" type="checkbox"/> Q ₂ H <input checked="" type="checkbox"/> <input type="checkbox"/> OK T <input type="checkbox"/> <input type="checkbox"/> Z	Q ₁ trigger input mode: With rising edge on Q ₁ , measured value is held until the next trigger occurs.	On = Q ₁ is a trigger input Off = Q ₁ is not a trigger input	Off
12 Q ₁ <input checked="" type="checkbox"/> <input checked="" type="checkbox"/> Q ₂ H <input checked="" type="checkbox"/> <input type="checkbox"/> OK T <input type="checkbox"/> <input type="checkbox"/> Z	Q ₁ enable input mode: Used to switch laser beam on and off. Laser beam is on when Q ₁ = +U _B . If Q ₁ = - U _B , the laser beam is switched off. Last measured value remains. When re-activated, the response time is prolonged according to the set mean value.	On = active Off = not active	Off
13 Q ₁ <input checked="" type="checkbox"/> <input checked="" type="checkbox"/> Q ₂ H <input checked="" type="checkbox"/> <input type="checkbox"/> OK T <input type="checkbox"/> <input type="checkbox"/> Z	Switches off averaging: The first measured value is taken into account (page 35).	On = Averaging off	On
14 Q ₁ <input type="checkbox"/> <input checked="" type="checkbox"/> Q ₂ H <input checked="" type="checkbox"/> <input type="checkbox"/> OK T <input type="checkbox"/> <input type="checkbox"/> Z	Switches on 4 ms averaging: the first 10 meas. values are taken into account (page 35).	On = active Off = not active	Off
15 Q ₁ <input checked="" type="checkbox"/> <input checked="" type="checkbox"/> Q ₂ H <input checked="" type="checkbox"/> <input type="checkbox"/> OK T <input type="checkbox"/> <input type="checkbox"/> Z	Switches on 40 ms averaging: all (max. 100) meas. values are taken into account (page 35).	On = active Off = not active	Off
16 Q ₁ <input type="checkbox"/> <input type="checkbox"/> Q ₂ H <input type="checkbox"/> <input checked="" type="checkbox"/> OK T <input type="checkbox"/> <input type="checkbox"/> Z	Set analogue output 0% (4 mA): When S button is activated, the current meas. value corresponds with 0% value of the analogue output.	On* = Object within... Off* = Object outside... ...measuring range	0% = 4 mA = end of meas. range
17 Q ₁ <input checked="" type="checkbox"/> <input type="checkbox"/> Q ₂ H <input type="checkbox"/> <input checked="" type="checkbox"/> OK T <input type="checkbox"/> <input type="checkbox"/> Z	Set analogue output 100% (20 mA): When S button is activated, the current meas. value corresponds with 100% value of the analogue output.	On* = Object within... Off* = Object outside... ...measuring range	100% = 20 mA = start of meas. range
18 Q ₁ <input type="checkbox"/> <input type="checkbox"/> Q ₂ H <input checked="" type="checkbox"/> <input checked="" type="checkbox"/> OK T <input type="checkbox"/> <input type="checkbox"/> Z	Q ₁ automatic zero mode: For characteristic curve displacement. If Q ₁ = +U _B , the current measuring signal is set to the analogue value 0 % = 4 mA. The incline of the characteristic curve is maintained. If exceeded, the characteristic curve ends at the start or end of the measuring range.	On = Automatic zero active Off = Automatic zero not active	Not active
19 Q ₁ <input checked="" type="checkbox"/> <input type="checkbox"/> Q ₂ H <input checked="" type="checkbox"/> <input checked="" type="checkbox"/> OK T <input type="checkbox"/> <input type="checkbox"/> Z	Q ₁ automatic centre mode: displacement of centre of characteristic curve. If Q ₁ = +U _B , the current measuring signal is set to the analogue value 50 % = 12 mA. The incline of the characteristic curve is maintained. If exceeded, the characteristic curve ends at the start or end of the measuring range.	On = Automatic centre active Off = Automatic centre not active	Not active

* as long as the S button is pressed



Mounting and operating instructions

No. LED Muster	Description	“ZA” status indicator	Factory setting
20 Q ₁ <input type="checkbox"/> <input type="checkbox"/> Q ₂ H <input type="checkbox"/> <input type="checkbox"/> OK T <input type="checkbox"/> <input type="checkbox"/> Z	Q ₁ maximum hold mode: Provided Q ₁ = +U _B , the max. recorded measured value is stored. If Q ₁ = -U _B , the determined value is transmitted at the analogue output. A minimum hold can be set by inverting the analogue characteristic curve (analogue 100% point < analogue 0 % point).	On = Maximum hold active Off = Maximum hold not active	Not active
21 Q ₁ <input type="checkbox"/> <input type="checkbox"/> Q ₂ H <input type="checkbox"/> <input type="checkbox"/> OK T <input type="checkbox"/> <input type="checkbox"/> Z	Q ₁ difference hold mode: Provided Q ₁ = +U _B , the difference between the measured values is saved. When Q ₁ = -U _B , the determined value is transmitted at the analogue output.	On = Difference hold active Off = Difference hold not active	Not active
22 Q ₁ <input type="checkbox"/> <input type="checkbox"/> Q ₂ H <input type="checkbox"/> <input type="checkbox"/> OK T <input type="checkbox"/> <input type="checkbox"/> Z	Activate factory settings: When the S button is pressed, the factory setting is activated.	ZA lights up as long as the S button is pressed	Not active
23 Q ₁ <input type="checkbox"/> <input type="checkbox"/> Q ₂ H <input type="checkbox"/> <input type="checkbox"/> OK T <input type="checkbox"/> <input type="checkbox"/> Z	Locking keys: If function is activated locking becomes active once the setting mode has been quit. Cancel locking with RESET or the unlocking function (see “Unlocking keys”)	On = Locking is active Off = Locking is not active	Not active
24 Q ₁ <input type="checkbox"/> <input type="checkbox"/> Q ₂ H <input type="checkbox"/> <input type="checkbox"/> OK T <input type="checkbox"/> <input type="checkbox"/> Z	Meas. value hold mode: If no object is in the measuring range (good target = off), the last meas. value is held at the analogue output.	On = Meas. value hold is active Off = Meas. value hold is not active	Not active
25 Q ₁ <input type="checkbox"/> <input type="checkbox"/> Q ₂ H <input type="checkbox"/> <input type="checkbox"/> OK T <input type="checkbox"/> <input type="checkbox"/> Z	Differential measurement mode master: Activate/deactivate (option /88 only) Description see differential measurement mode (page 38).	On = Differential measurement mode - master is active Off = Differential measurement mode - master is not active	Not active
26 Q ₁ <input type="checkbox"/> <input type="checkbox"/> Q ₂ H <input type="checkbox"/> <input type="checkbox"/> OK T <input type="checkbox"/> <input type="checkbox"/> Z	Differential measurement mode slave: Activate/deactivate (option /88 only) Description see differential measurement mode (page 38).	On = Differential measurement mode - slave is active Off = Differential measurement mode - slave is not active	Not active

Reset

Q₁ Q₂
 H OK
 T Z

When switching on the sensor (power on), keep the S button pressed (approx. 10 seconds) until the LED lights stop flashing and are permanently on. The BA power supply indicator is green. When the S button is released, a Reset is carried out which returns the VDM18 to delivery status where factory settings are active.
 (See table of functions page 32-34).

Unlocking keys

Q₁ Q₂
 H OK
 T Z

When switching on the sensor (power on), keep the T button pressed (approx. 10 seconds) until the LED lights stop flashing and are permanently on. The ZA status indicator is red. When the T button is released, the setting mode is unlocked.



Averaging

The measuring result (output signal) is smoothed by averaging. The measured values are read continuously into a memory and the arithmetical mean is formed. Functions 14 and 15 (page 33) determine the number of measurements (10 or 100) to be used for averaging.

With a scanning rate of 0.4 ms per measurement, the response time lies between 0.4 ms (without averaging) and 40 ms.

Example of use: When measuring rough surfaces, it is possible to counter-balance fluctuations in measured values.

Response time

0.4 ms = measured value (no average)

4 ms = averaging with 10 measured values

40 ms = averaging with 100 measured values

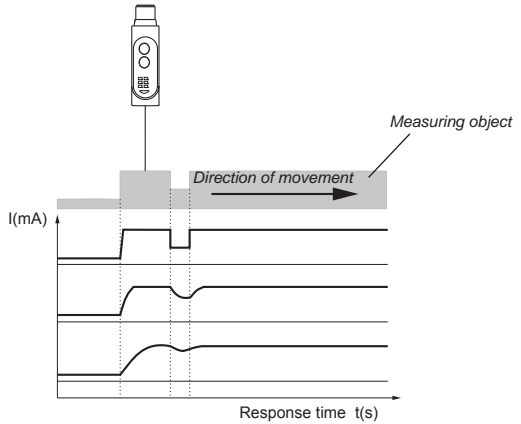

Illustr. 10 Output characteristics in relation to arithmetical mean

Automatic zero mode

The output characteristic curve 4 – 20 mA is displaced with this function. When the automatic zero mode is activated and $Q_1 = +U_B$, the current measured value is equated with the output value of 0% = 4 mA. The incline of the characteristic curve is maintained and the minimum and maximum values of the characteristic curve are limited by the measuring range.

The distance to the object must be within the measuring range.

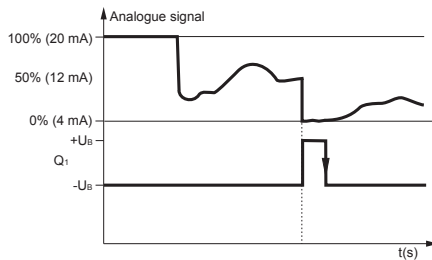

Illustr. 11

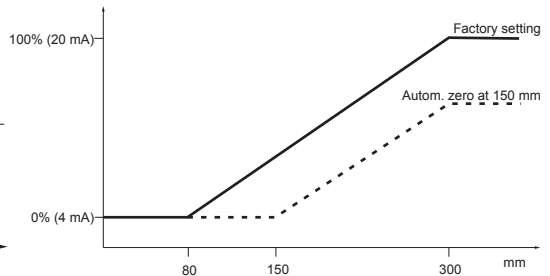

Illustr. 12



Automatic centre mode

The output characteristic curve 4 – 20 mA is displaced with this function. When the automatic centre function is activated and $Q_1 = +U_B$, the current measured value is equated with the output value of 50% = 12 mA. The incline of the characteristic curve is maintained and the minimum and maximum values of the characteristic curve are limited by the measuring range.

The distance to the object must be within the measuring range.

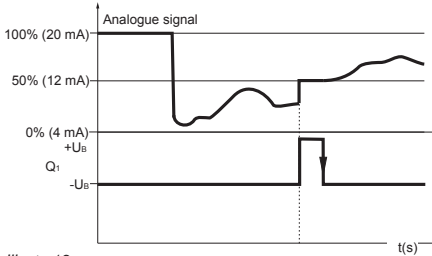

Illustr. 13

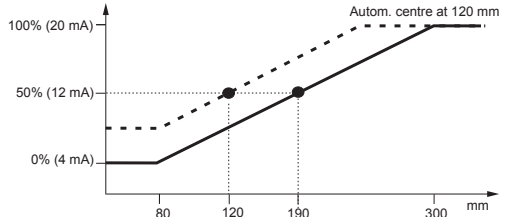

Illustr. 14

Maximum hold mode

When maximum hold mode is activated and $Q_1 = +U_B$, this function detects the maximum value of the measuring signal and stores it.

If $Q_1 = -U_B$, the last maximum value is transmitted at the analogue output.

Example of use: determining the maximum value of a shaft

The minimum value can be determined by inverting the analogue output characteristic (see function no. 16 and 17).

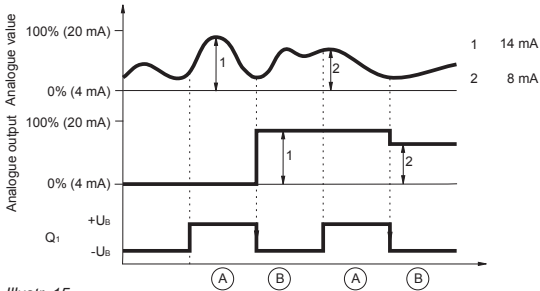

Illustr. 15

Perfnummer: 194551

Date of issue: 08/08/2011



Difference hold mode

When the difference hold function is activated and $Q_1 = +U_B$, this function detects the difference between the minimum and maximum value of the measuring signal and stores it.

If $Q_1 = -U_B$, the last differential value is transmitted at the analogue output.

Example of use: Checking the contents of open containers or packages.

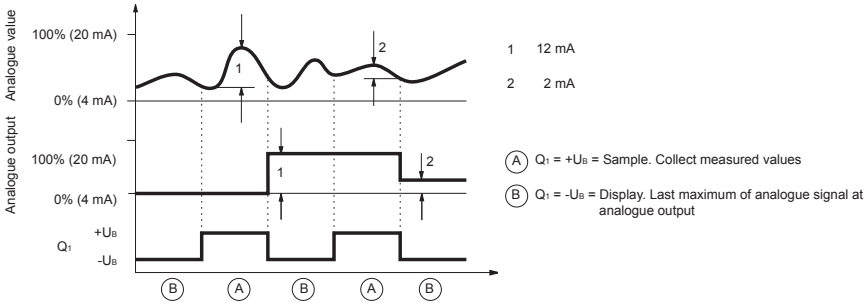

Illustr. 16
15500149

Measured value hold mode

When this function is activated, the last valid measured value is saved.

When no object is in the measuring range, the last valid measured value is transmitted at the analogue output. The current value is only displayed again when an object is within the measuring range (OK LED = on).

Example of use: Maintain position of tool during change-over of work piece when machining.

Behaviour of analogue output with and without measured value hold.

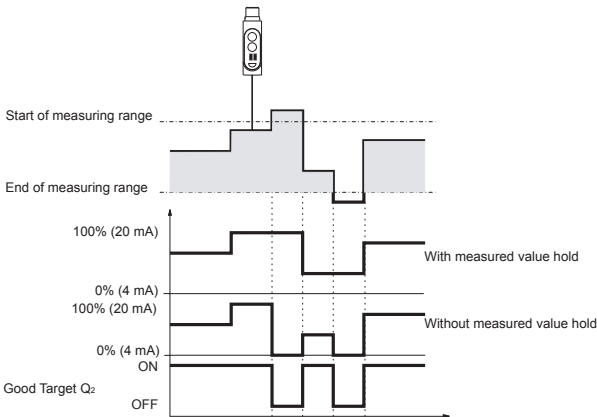

Illustr. 17



Differential measurement mode



Differential measurement can only be used with /88 option of VDM18.

Simultaneous connection to SPC control or a PC via the RS 485 interface is not possible with differential measurement.

With this measuring procedure, two VDM18.../88 sensors are connected to one another. The measuring ranges can overlap (1), be directly adjacent (2) or apart (3) (Illustr. 18).

To achieve optimum use of the measuring range, the measuring object should if possible be aligned in the centre of the measuring range.

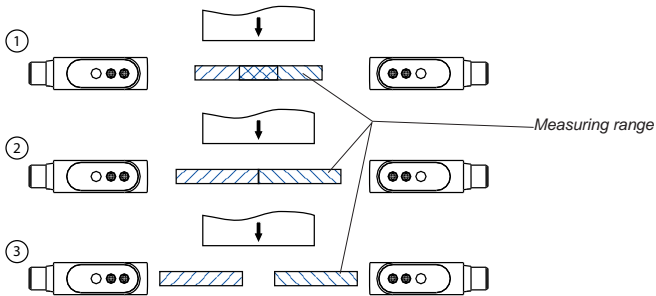

Illustr. 18

The following steps must be carried out for differential measurement:

1. Mount both VDM18.../88 sensors.
2. Connect sensors according to the electrical connection diagram

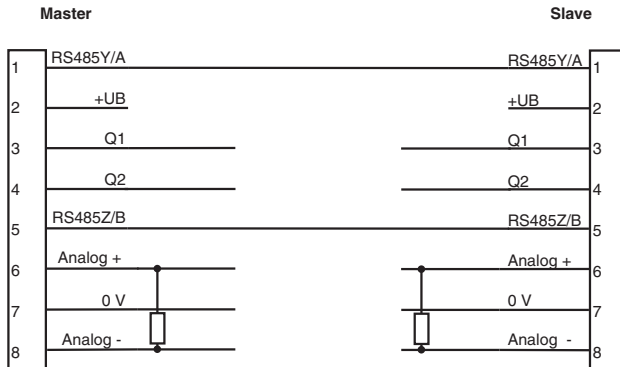

Illustr. 19

3. One of the sensors must be configured as a slave. Activate function 26 (see "Settings", page 32)



4. Insert reference object of known width in measuring range.
Warning: LED "OK" (Good target) must light up on both sensors.
5. Configure the second VDM18.../88 sensor as the master. Activate function no. 25 (page 34).
Warning: The sensor can only be configured as a master when the object is inside the measuring range of both sensors (see point 4).
6. The analogue value on the master corresponds with the measured reference width and the 50% value (autom. centre function) of 12 mA. All function settings on the master are based on the difference in thickness.
7. Feed objects into the measuring range to start measurement.
8. The measured value provides the difference to the reference width and is at the analogue output of the master. The analogue output of the slave supplies the distance to the object.



We recommend resetting sensors to factory setting (function 22, page 34) before configuration of sensors as master or slave.

In differential measurement mode, resolution and linearity must be multiplied by 2, because 2 sensors are used.



Sensor configuration with the VDMConfig software

The operating software "VDMConfig" is available to facilitate programming of versions /88 Its simulation mode indicates the correct bus commands for the respective case.

For more information see our homepage: www.pepperl-fuchs.com and the order information on page 44.

Transmission protocol

Transmission frame

The bus-compatible RS 485 interface of VDM18.../88 operates in half-duplex mode (1 Stopbit, no parity).

As a rule, the VDM18.../88 sensor is a slave and only sends data when addressed by a higher ranking control system (master) except difference measuring.

A baudrate of 38,4 Kbaud and the following protocol must be observed for data transmission:

• 7 data bits + 1 address bit (MSB)	MSB address bit	6...1 LSB 7 data / address bits
-------------------------------------	--------------------	------------------------------------

Procedure:

When the address bit has been set, the VDM18.../88 sensor compares the bus address with its own. If they match, the VDM18.../88 sensor interprets all further data and sends an appropriate feedback signal.

The structure of the transmission frame is as follows:

1st byte	2nd byte	3rd byte	...	Last byte
Request from master:				
Address of slave	Length	Command	Parameter(s)	Checksum
Answer from slave:				
Address of slave	Length	Command	Parameter(s)	Checksum

Length = Number of characters incl. checksum and address byte

Command = See table of bus commands on page 41

Parameters = Parameter byte 0 to n, depending on command. The slave sends the requested data in this range.

Checksum = Exclusive OR of all characters sent incl. address byte

Slave answers:

Address of slave	4	N*1	Checksum	
Address of slave	4	Y*2	Checksum	
Address of slave	4 + n	Y	1 st parameter, 2 nd parameter, 3 rd parameter, ..., n parameter	Checksum

*1 is sent when an error regarding checksum, frame length or parameter / command occurs.

*2 is sent when the command has been carried out.



Bus commands

Command (ASCII)	Hex	Description of command	Master parameters (5 th byte and following) hex	
1	31	Signal output Q1	1	High byte switching point 1 see 1) page 42
			2	Low byte switching point 1 see 1) page 42
			3	Configuration: D0: 1 = N.O., 0 = N.C D1: 1 = pulse stretching 0 = off, see 2) page 42
			4	High byte switching point 2 see 1) page 42
			5	Low byte switching point 2 is sent for high and low byte 00, if there is no second switching point, see 1) page 42
2	32	Signal output Q2	1	High byte switching point 1 see 1) page 42
			2	Low byte switching point 1 see 1) page 42
			3	Configuration: D0: 1 = N.O., 0 = N.C D1: 1 = pulse stretching 0 = off, see 2) page 42
			4	High byte switching point 2 see 1) page 42
			5	Low byte switching point 2 is sent for high and low byte 00, if there is no second switching point, see 1) page 42
G	47	Good Target		
T	54	Q1 is trigger input		
E	45	Q1 is enable input		
B	42	Averaging	D0 = 1	= 0.4 ms (averaging off)
			D1 = 1	= 4 ms (10 measured values)
			D2 = 1	= 40 ms (100 measured values)
N	4E	Characteristic curve 0% point	See 1) page 42	
H	48	Characteristic curve 100% point	See 1) page 42	
Z	5A	Q1 is automatic zero		
C	43	Q1 is automatic centre		
X	58	Maximum search		
M	4D	Minimum search		
D	44	Difference search		
W	57	Factory setting		
V	56	Key lock	Settings see 2) page 42 D0 = 0 not active D0 = 1 active	
S	53	Store EEPROM		
Q	51	Q1 input software confirmation explanation	Settings see 2) page 42 D0 = 0 Q1 = off D0 = 1 Q2 = on	
A	41	Distance measuring values	See 3) page 42	
I	49	Operating measuring values	See 3) page 42	
F	46	Fast measured value output	See 4) page 42	
L	4G	Change slave address	See 2) page 42	
?	3F	Read sensor setting	See 5) page 42	



Explanations on bus commands

1)

Highbyte

0	0	D11	D10	D9	D8	D7	D6
---	---	-----	-----	----	----	----	----

Lowbyte

0	0	D5	D4	D3	D2	D1	D0
---	---	----	----	----	----	----	----

D0 - D11 = distance value 0 - 4095 (according to the set measuring range)

2)

Byte

0	D6	D5	D4	D3	D2	D1	D0
---	----	----	----	----	----	----	----

3)

Highbyte

0	GT	D11	D10	D9	D8	D7	D6
---	----	-----	-----	----	----	----	----

D0 - D11 = distance value (0 - 4095)

GT = Good Target

Lowbyte

0	Q1	D5	D4	D3	D2	D1	D0
---	----	----	----	----	----	----	----

Q1 = status of Q1

4)

Highbyte

0	1	D11	D10	D9	D8	D7	D6
---	---	-----	-----	----	----	----	----

D0 - D11 = distance value (0 - 4095)

Bit6 = 1: High byte

Bit6 = 0: Low byte

Lowbyte

0	0	D5	D4	D3	D2	D1	D0
---	---	----	----	----	----	----	----

5)

After input of "?", the sensor setting is transmitted as follows:

1	Function 1 High byte	D8: trigger input D9: Q1 is enable input D10: X D11: Maximum hold D12: Difference hold D13: Q1 is software input D14: fast meas. value output
2	Function 1 Low byte	D0: Q1 is signal output D1: Q1 is scanning zone D2: Q1 is signal output inversion (1 = N.C.) D3: Q1 is signal output pulse stretching D4: Minimum hold D5: Autom. zero D6: Autom. centre
3	Function 2 High byte	D8 ... D14: Identification of variants
4	Function 2 Low byte	D0: Q1 is signal output D1: Q1 is scanning zone D2: Q1 is signal output inversion (1 = N.C.) D3: Q1 is signal output pulse stretching D4: Q2 is good target output D5 ... D6: X
5	Function 3 High byte	D8: Measured value hold D9, D10: X D11: Key lock D12 ... D14: X
6	Function 3 Low byte	D0: Mean value 0.4 ms D1: Mean value 4 ms D2: Mean value 40 ms D3 ... D6: X
7	Characteristic curve 0% High byte	See 1)
8	Characteristic curve 0% Low byte	See 1)
9	Characteristic curve 100% High byte	See 1)
10	Characteristic curve 100% Low byte	See 1)
11	Switching threshold Q1 High byte	See 1)
12	Switching threshold Q1 Low byte	See 1)
13	Scanning zone Q1 High byte	See 1)
14	Scanning zone Q1 Low byte	See 1)
15	Switching threshold Q2 High byte	See 1)
16	Switching threshold Q2 Low byte	See 1)
17	Scanning zone Q2 High byte	See 1)
18	Scanning zone Q2 Low byte	See 1)



Optical data (typ.)

Operating range VDM18-100	30 ... 100 mm
Measuring range VDM18-100	70 mm
Operating range VDM18-300	80 ... 300 mm
Measuring range VDM18-300	220 mm
Resolution* ¹	<0.1% of measuring range
Light used	Pulsed laser light, red 650 nm, MTBF>50,000h * ²
Size of light spot	See Illustr. 4 page 28
Ambient light	Constant light 5000 lux as per EN 60947-5-2
Laser protection class	2 (EN 60825/1)

Electrical data (typ.),

Operating voltage U_B	18-30 V DC * ³
Power consumption (no load)	≤ 40 mA at 24 V DC
Signal outputs	Q1/Q2 (PNP or NPN, N.O. / N.C. selectable)
Output current Q1, Q2	≤ 100 mA
Switching frequency Q1, Q2	≤ 1 kHz
Response time Q1, Q2, QA	0.4 ms (when averaging = off) / 4 ms / 40 ms
Maximum capacitive load Q1, Q2	< 100 nF
Pulse stretching Q1, Q2	50 ms (when activated)
Analogue output QA	4-20 mA* ⁴
Interface	RS485 (/88 option only)
Non-Linearity	<0.25% of measuring range
Temperature drift	< 0.02% / °C
Protective circuits	Reverse battery protection, short circuit protection (not RS 485)
VDE protection class * ⁵	
Stand-by delay	≤ 300 ms

Mechanical data

Housing material	ABS, shock-resistant
Front screen	PMMA
Protection	IP 67* ⁶
Ambient temperature range	-10 to +60 °C
Storage temperature range	-20 to +80 °C
Connection	M12 connector, 8-pin
Weight	approx. 43 g

- *1 smallest, measurable difference
- *2 at ambient temperature : +40 °C
- *3 limit values
- *4 recommended burden ≤ 500 Ohm (apparent ohmic resistance)
- *5 rating 50V DC
- *6 with attached connector



Order information

Sensor type	Description
VDM18-100/20/122/151	Distance sensor, 30 to 100 mm, Resolution 0.1% of measuring range, 2 x PNP, N.O/N.C., 4 to 20 mA, M12 8-pin connector
VDM18-100/20/88/122/151	Distance sensor, 30 to 100 mm, Resolution 0.1% of measuring range, 2 x PNP, N.O/N.C., 4 to 20 mA, RS485, M12 8-pin connector
VDM18-300/20/122/151	Distance sensor, 80 to 300 mm, Resolution 0.1% of measuring range, 2 x PNP, N.O/N.C., 4 to 20 mA, M12 8-pin connector
VDM18-300/20/88/122/151	Distance sensor, 80 to 300 mm, Resolution 0.1% of measuring range, 2 x PNP, N.O/N.C., 4 to 20 mA, RS485, M12 8-pin connector
VDM18-300/21/122/151	Distance sensor, 80 to 300 mm, Resolution 0.1% of measuring range, 2 x NPN, N.O/N.C., 4 to 20 mA, M12 8-pin connector

Accessories (not included in standard delivery)

Accessory	Description
V17-G-5M-PUR	Connection cable M12, 8-pin, 5 m in length, straight, PUR
V17-G-2M-PUR	Connection cable M12, 8-pin, 2 m in length, straight, PUR
OMH-VDM18-01	Recommended mounting bracket
OMH-VDM18-02	Recommended mounting bracket
VDMConfig	Software
Interface Cable RS232-RS485	Interface converter RS 485/422 to RS 232
Interface Cable RS232-USB	Interface cable incl. CD-ROM USB-RS 232



To operate the VDM18 sensor on a PC, the PC must be equipped with a RS 485 interface. If this is not the case the existing interface (RS 232, USB, etc.) can be used with a adaptor.

If your PC has a RS 232 interface, we recommend to use the RS 232 converter Interface Cable RS232-RS485.

If your PC has only a USB interface, you will need in addition the interface cable RS232-USB.

*See article number in accessories list above



Data sheets, instruction manuals and software can be downloaded from www.pepperl-fuchs.com



RS485 / RS422 <-> RS232 - Converter Setup

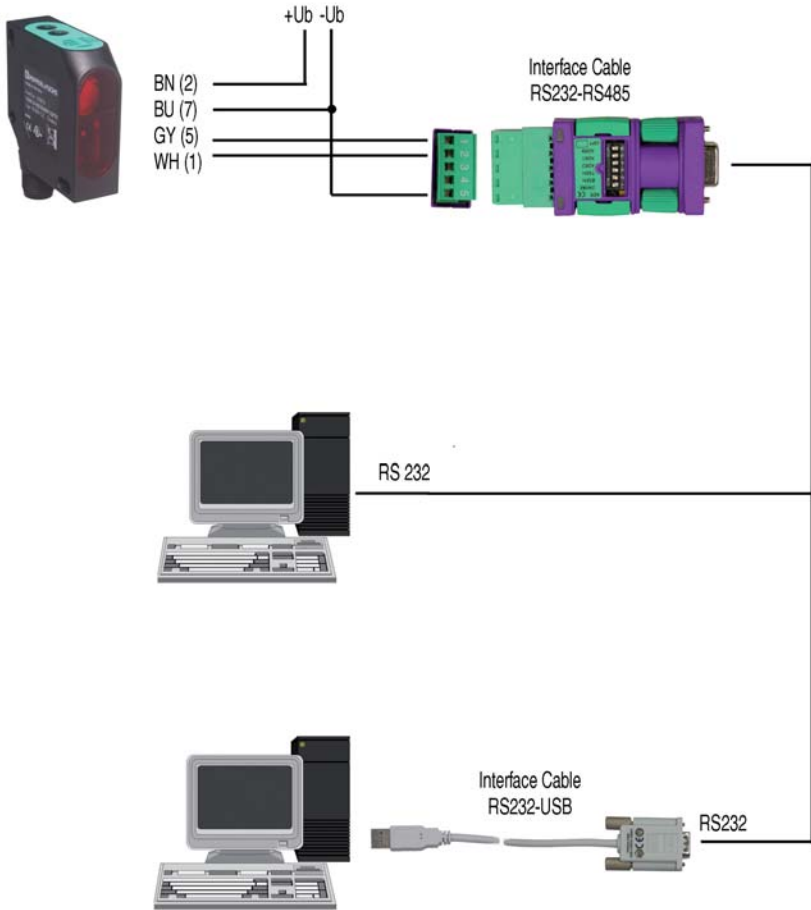

FACTORY AUTOMATION – SENSING YOUR NEEDS



Worldwide Headquarters

Pepperl+Fuchs GmbH · Mannheim · Germany
E-mail: fa-info@pepperl-fuchs.com

USA Headquarters

Pepperl+Fuchs Inc. · Twinsburg, OH · USA
E-mail: fa-info@us.pepperl-fuchs.com

Asia Pacific Headquarters

Pepperl+Fuchs Pte Ltd · Singapore
Company Registration No. 199003130E
E-mail: fa-info@sg.pepperl-fuchs.com

www.pepperl-fuchs.com

 **PEPPERL+FUCHS**
SENSING YOUR NEEDS

Subject to modifications without notice
Copyright Pepperl+Fuchs · Printed in Germany

DOCT-1314A

194551
08/2011