

ifm electronic



Operating instructions  
Flow monitor

**efector300<sup>®</sup>**

**SI0558**

**UK**

706335 / 00 03 / 2013

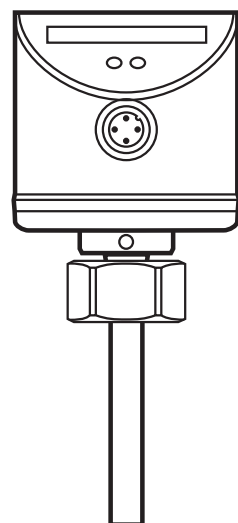

# Contents

1 Preliminary note.....	3
1.1 Explanation of symbols.....	3
2 Safety instructions .....	3
3 Functions and features .....	4
3.1 Applications .....	4
3.2 Operating principle flow monitoring .....	4
4 Installation.....	5
4.1 Installation location .....	5
4.2 Interference in the pipe system .....	6
4.3 Installation procedure .....	6
5 Electrical connection.....	7
6 Operating and display elements .....	8
7 Parameter setting .....	8
7.1 Set-up .....	8
7.2 Change the switch point (optional) .....	8
7.3 Automatic adjustment (Teach function).....	9
7.4 Restore the factory setting (reset) .....	9
7.5 Lock / unlock the unit.....	9
8 Operation .....	10
9 Maintenance .....	11

# 1 Preliminary note

## 1.1 Explanation of symbols

▶ Instructions

> Reaction, result

[...] Designation of keys, buttons or indications

→ Cross-reference



Important note

Non-compliance can result in malfunction or interference.



Information

Supplementary note.

UK

## 2 Safety instructions

- Please read the product description prior to set-up of the unit. Ensure that the product is suitable for your application without any restrictions.
- The unit conforms to the relevant regulations and EC directives.
- Improper or non-intended use may lead to malfunctions of the unit or to unwanted effects in your application.
- That is why installation, electrical connection, set-up, operation and maintenance of the unit must only be carried out by qualified personnel authorised by the machine operator.

## **3 Functions and features**

### **3.1 Applications**

The unit monitors the flow in liquid and gaseous media.

### **3.2 Operating principle flow monitoring**

- The unit detects the flow speed to the calorimetric measuring principle and switches the output:
  - output closed if medium is flowing / output open if no medium is flowing.
- The typical response time of the unit is 1...10 s. It can be influenced by setting the switch point:
  - Low switch point = quick reaction with rising flow.
  - High switch point = quick reaction with falling flow.

## 4 Installation

Using process adapters the unit can be adapted to different process connections.

- The adapters have to be ordered separately as accessories. A correct fit of the unit and ingress resistance of the connection are only ensured using ifm adapters.
- For small flow rates ifm adapter blocks are available.

### 4.1 Installation location

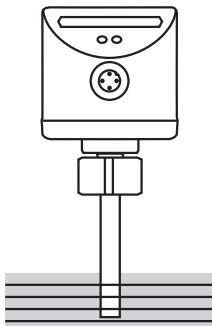
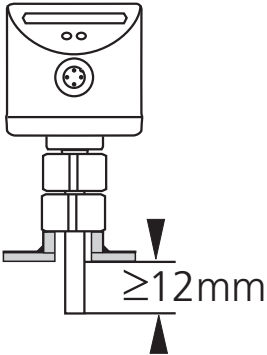
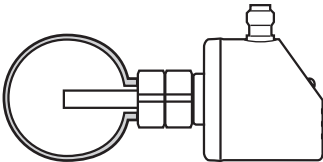
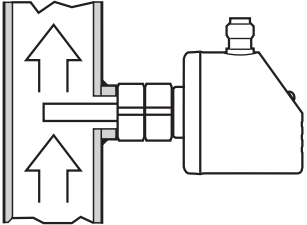
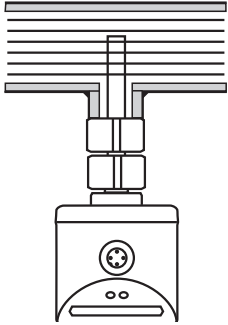
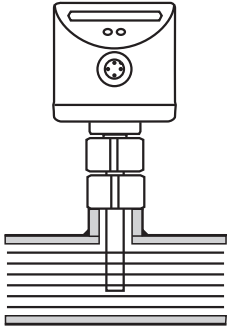
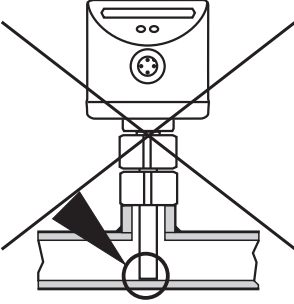
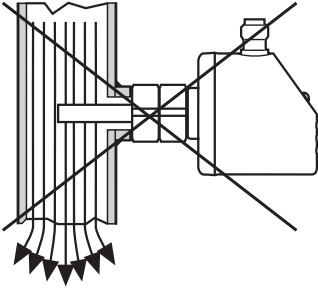
<p><b>General</b></p> <ul style="list-style-type: none"> <li>• The sensor tip is to be completely surrounded by the medium.</li> <li>• Insertion depth of the sensor: minimum 12 mm.</li> </ul>		
<p><b>Recommended</b></p> <ul style="list-style-type: none"> <li>• For horizontal pipes: mounting from the side.</li> <li>• For vertical pipes: mounting in the rising pipe.</li> </ul>		
<p><b>Conditional</b></p> <ul style="list-style-type: none"> <li>• Horizontal pipe /mounting from the bottom: if the pipe is free from build-up.</li> <li>• Horizontal pipe /mounting from the top: if the pipe is completely filled with medium.</li> </ul>		
<p><b>To avoid</b></p> <ul style="list-style-type: none"> <li>• The sensor tip must not be in contact with the pipe wall.</li> <li>• Do not mount in downpipes that are open at the bottom!</li> </ul>		

## 4.2 Interference in the pipe system

Components integrated in the pipes, bends, valves, reductions, etc. lead to turbulence of the medium. This affects the function of the unit.

Recommendation: adhere to the distances between sensor and sources of interference:

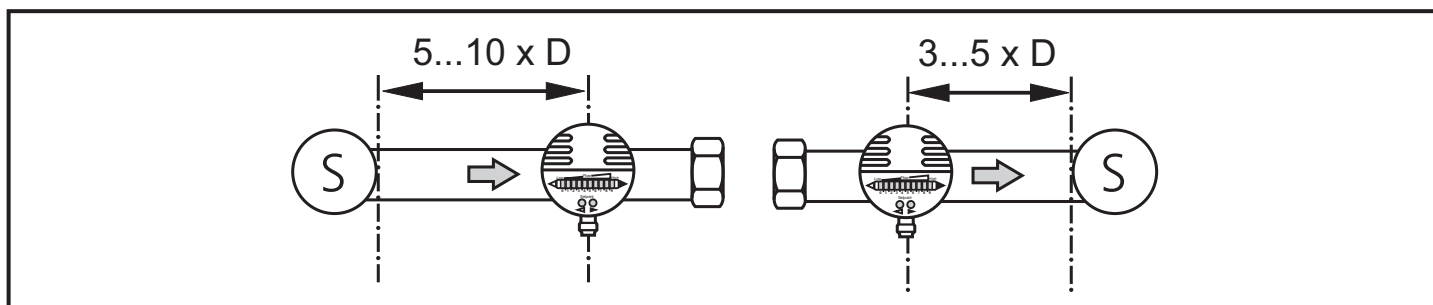

D = pipe diameter; S = sources of interference

## 4.3 Installation procedure



- ▶ Ensure that the system is free of pressure during installation.
- ▶ Ensure that no media can leak at the mounting location during installation.

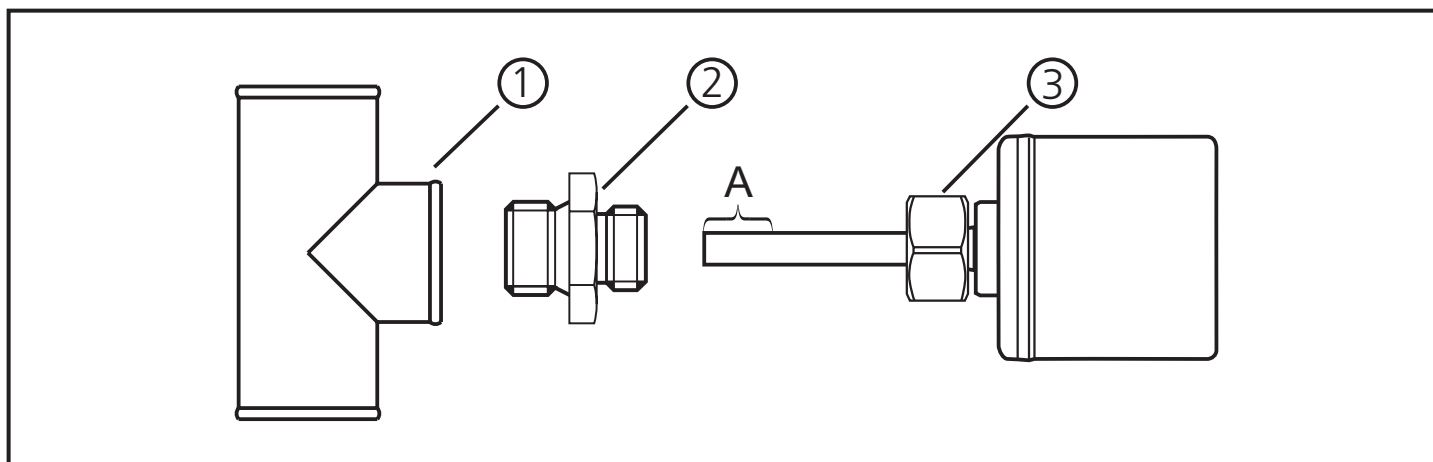

- ▶ Grease the threads of the process connection (1), adapter (2) and nut (3).



- ▶ No grease must be applied to the sensor tip (A).

- ▶ Screw the suitable adapter into the process connection.
- ▶ Place the flow monitor onto the adapter and tighten the nut. Tightening torque 25 Nm. Ensure that the unit is correctly oriented.

## 5 Electrical connection



The unit must be connected by a qualified electrician.

The national and international regulations for the installation of electrical equipment must be adhered to.

Voltage supply according to EN 50178, SELV, PELV.

- ▶ Disconnect power.
- ▶ Connect the unit as follows:

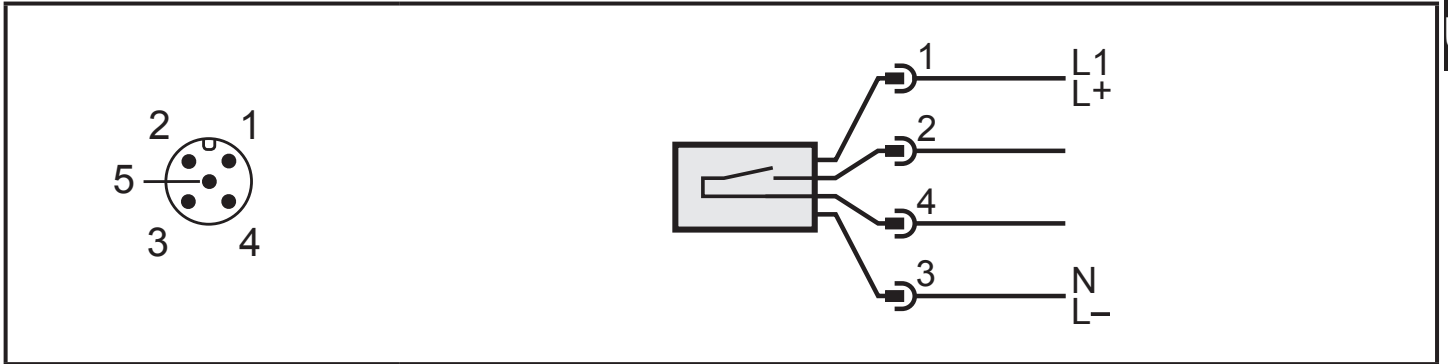

core colours of ifm sockets:

1 = BN (brown), 2 = WH (white), 3 = BU (blue), 4 = BK (black)



- ▶ Do not connect pin 5.



- ▶ For the output circuit take the same protective measures as for the supply circuit. Insert a miniature fuse according to IEC 60127-2 Sheet 1 ( $\leq 5$  A fast acting).

# 6 Operating and display elements

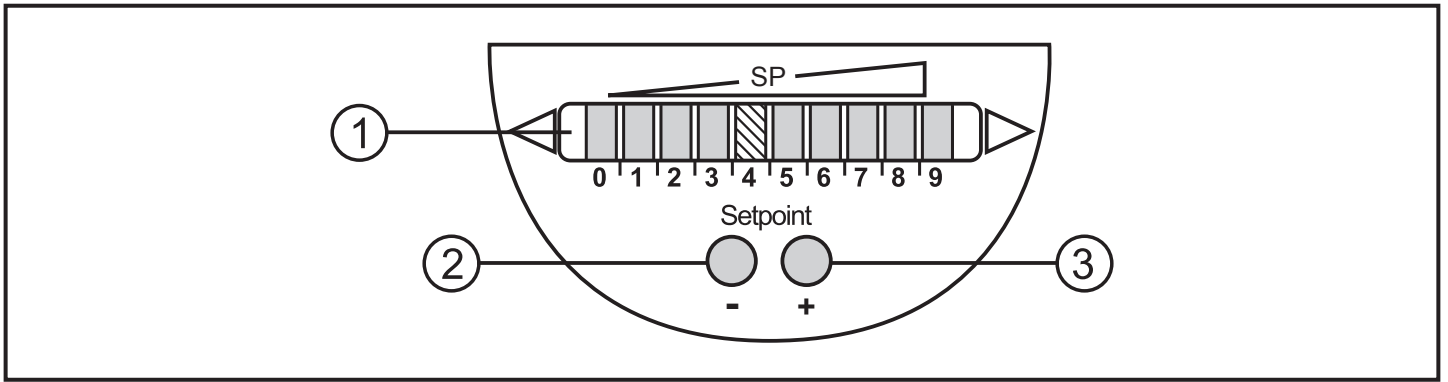

## 1: Operating indicators

- The green LEDs indicate the current flow (LEDs 0 to 9 represent the range of the monitored flow).
- A lighting LED indicates the position of the switch point (orange = output closed, red = output open).

## 2, 3: Setting buttons for adjustment and configuration

# 7 Parameter setting

## 7.1 Set-up

- ▶ Switch on the supply voltage.
- > All LEDs light and go out again step by step. During this time the output is closed.
- > The unit is in the operating mode.

## 7.2 Change the switch point (optional)

A change makes sense in the following cases:

- the flow fluctuates much or pulsates.
- if a faster response time of the unit is requested (low switch point = fast response with rising flow, high switch point = fast response with falling flow).
- ▶ Briefly press the pushbutton **-** or **+**.
- > All LEDs are off.
- ▶ Press the pushbutton **-** or **+** as often as required. Each press of the pushbutton shifts the flow by one half LED in the indicated direction.
- > As soon as a button is pressed, the LEDs are switched on. The LEDs of the current process value are flashing.





If no pushbutton is pressed for 2 s, the unit returns to the operating mode with the newly set value.

### **7.3 Automatic adjustment (Teach function)**

- ▶ Press the **-** button for at least 15 s.
  - > First the LEDs 0 and 9 light green, then they are flashing green.
- ▶ Release the button.
  - > The unit adopts the new value and returns to the operating mode.
  - > All LEDs left of the switch point light green. The switch point LED lights red.

UK

### **7.4 Restore the factory setting (reset)**

- ▶ Press the **+** button for at least 15 s.
  - > All LEDs first light orange, then they are flashing orange.
- ▶ Release the button.
  - > All settings are reset to the factory setting:
    - Switch point: 20 cm/s
    - Not locked.
  - > All LEDs go off for 2 s.

### **7.5 Lock / unlock the unit**







The unit can be locked electronically to prevent unintentional settings.

- ▶ Press both setting buttons simultaneously for 10 s in the operating mode.
  - > The indication goes out, the unit locks or unlocks.

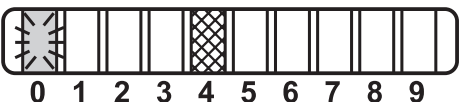
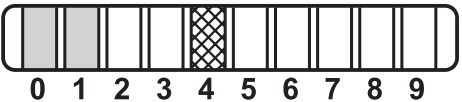
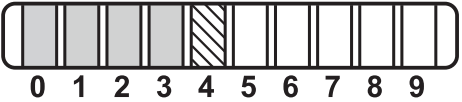
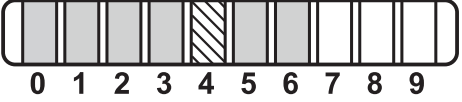
When delivered: not locked.

# 8 Operation

In case of power failure or interruption of the operating voltage all settings remain.

Operating indicators	
	Current flow below the display range.
	Current flow below the switch point.
	Current flow corresponds to the switch point.
	Current flow above the switch point.
	Current flow above the display range.
Interference indicators	
The display goes OFF briefly (LEDs go off when a button is pressed)	If the sensor is permanently locked, the active LEDs go off briefly when a button is pressed. (→ 7.5). After approx. 0.6 seconds the last operating status is indicated.
All LEDs are flashing red	Automatic adjustment not successful. The switch point is outside the measuring range. ▶ Check flow and mounting, if necessary repeat adjustment (→ 7.3).
Display OFF (no LED lights):	Operating voltage too low (< 19 V) or failed. ▶ Ensure correct voltage supply.
<p>Explanation of symbols:</p> <ul style="list-style-type: none"> <li> LED lights green</li> <li> LED lights orange</li> <li> LED lights red</li> <li> LED flashes</li> </ul>	

## 9 Maintenance

Recommended maintenance:

- ▶ Check the sensor tip for build-up from time to time.
- ▶ Clean it using a soft cloth. Stubborn build-up (e.g. lime) can be removed using a common vinegar cleaning agent.