

S6 SERIES INSTRUCTION MANUAL

CONTROLS

OUTPUT LED

The red LED indicates the output status.

STABILITY LED (S6/S6T/S6R-5-M25)

The green LED ON indicates that the received signal has a reserve greater than 30% compared to the output switching value.

SENSITIVITY TRIMMER (S6/S6T/S6R-x-A/B/C/F/T)

ADJUSTMENT SCREW (S6/S6T/S6R-5-M25)

This control can be used to adjust sensitivity (trimmer) or cutoff distance (screw); the operating distance increases turning the control clockwise.

DARK/LIGHT TRIMMER (S6-1-A/B/C/F/T)

The DARK/LIGHT mode can be set rotating the trimmer counterclockwise or clockwise.

WARNING: The trimmers rotation is limited to 270° by a mechanical stop. Do not apply excessive torque when adjusting (max 40 Nmm).

POWER ON LED (S6/S6T-x-G)

The red LED indicates that the sensor is operating.

CONNECTIONS

S6-5-A/B/C/M/T

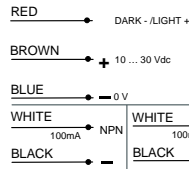

S6-5-F

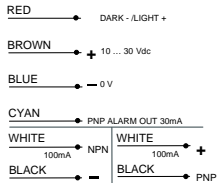

S6-5-G

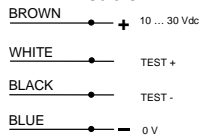

S6R-5-A/B/C/F/M/T

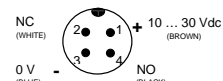

S6T-5-A/B/C/F/M/T



S6T-5-A/B/C/F/M/T

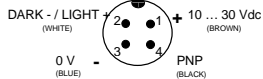

S6-1-A/B/C/F/T

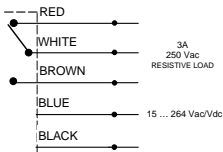

S6-1-G

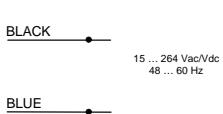

DIMENSIONS

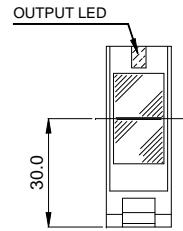
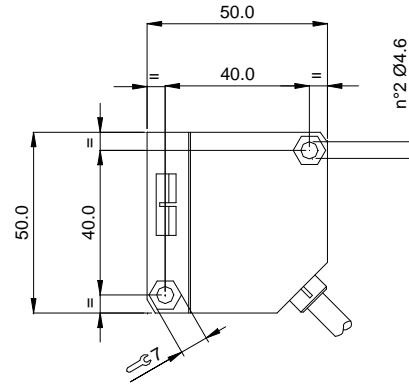

S6/S6T/S6R-5-M25

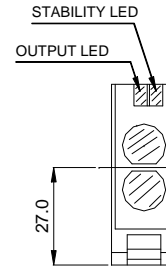

M12 CONNECTOR S6T/S6R-5-xx

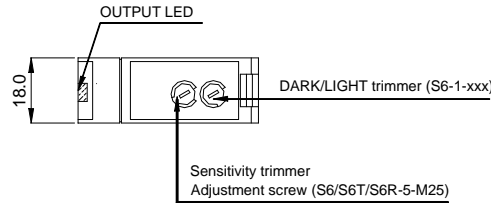
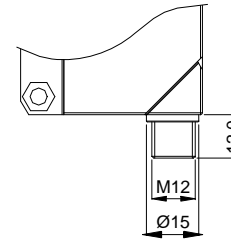

TECHNICAL DATA

	S6/S6T/S6R-5-xx	S6-1-xx
Power supply:	10 ... 30 Vdc limit values	15 ... 264 Vac (48 ... 60 Hz) limit values
Ripple:	2 Vpp max.	-
Current consumption (output current excluded):	30 mA max.	40 mA max.
Output:	S6: NPN/PNP; 30 Vdc max. S6T: PNP; 30 Vdc max. S6R: NPN or PNP NC/NO; 30 Vdc max.	Relay 1 NO and NC contact 250 Vac, 30 Vdc min.applicable load: 5 Vdc, 10 mA
Output current:	100 mA max. (short-circuit protection)	3 A max. (resistive load)
Output saturation voltage:	1.5 V max. (NPN/PNP output)	-
Response time:	1 ms max. / 2 ms max. mod. F/G	30 ms max.
Switching frequency:	500 Hz max. / 250 Hz max. mod. F/G	2 Hz max.
Indicators:	OUTPUT LED (RED) / STABILITY LED (GREEN) mod. M25 / POWER ON LED (RED) mod. G	
Setting:	sensitivity trimmer excluding mod. G/M10 adjustment screw mod. M25	sensitivity trimmer excluding mod. G dark/light trimmer excluding mod. G
Operating temperature:		-25 ... 55 °C
Storage temperature:		-25 ... 70 °C
Electric shock protection:	Class 2	Class 1
Operating distance (minimum):	A6 0.1 ... 6 m on R2 / B5 0.1 ... 5 m on R2 / T1: 0.1 ... 1 m on R2 C90: 1 ... 90 cm / C200: 1 ... 200 cm M10: 3 ... 10 cm / M25: 3 ... 25 cm F20/G20: 0 ... 20 m	
Emission type:	INFRARED (880 nm) / RED (660 nm) mod. B/T/M10	
Ambient light rejection:	according to EN 60947-5-2	
Vibration:	0.5 mm amplitude, 10 ... 55 Hz frequency, for every axis (EN60068-2-6)	
Shock resistance:	11 ms (30 G) 6 shock for every axis (EN60068-2-27)	
LIGHT/DARK selection:	cable or connector	trimmer
Housing:	ABS UL 94V-O	
Lenses:	PMMA plastic	
Protection class:	IP65	
Connections:	2 m cable Ø 6 mm vers. S6-1 and Ø 5 mm vers. S6-5 / M12 4-pole connector vers. S6T/S6R	
Weight:	160 g. max. cable versions / 40 g. max. connector versions	

SETTING

The following procedures are valid for LIGHT mode operation.

Alignment S6/S6T/S6R-x-A/B/T

Position the sensor and reflector on opposite sides. Turn the sensitivity trimmer to maximum. Find the points where the red LED (OUT) is switched ON and OFF in both vertical and horizontal positions, and fix the sensor in the centre between these points. If necessary, reduce sensitivity using the trimmer, in order to detect very small or transparent targets. In order to improve alignment, repeat the procedure detailed above whilst progressively reducing the sensitivity.

Alignment S6/S6T/S6R-x-F/G

Position the sensors on opposite sides. Turn the sensitivity trimmer to maximum. Find the points where the red LED (OUT) is switched ON and OFF in both vertical and horizontal positions, and fix the sensor in the centre between these points. If necessary, reduce sensitivity using the trimmer, in order to detect very small targets. In order to improve alignment, repeat the procedure detailed above whilst progressively reducing the sensitivity.

Alignment S6/S6T/S6R-x-C

Position the sensor and turn the sensitivity trimmer at minimum: the red LED is OFF. Place the target opposite the sensor. Turn the sensitivity trimmer clockwise until red LED turns ON. (Target detected state, pos.A).



Remove the target, the red LED turns OFF. Turn the trimmer clockwise until the red LED turns ON (Background detected state, pos.B).

The trimmer reaches maximum if the background is not detected. Turn the trimmer to the intermediate position C, between the two positions A and B.

Alignment S6/S6T/S6R-5-M25

Position the sensor and turn the adjustment screw to maximum. Place the target opposite the sensor at a slightly greater distance than desired. Turn the screw counterclockwise until the sensor switches.

Verify the adjustment moving the target closer and further the sensor; tune the adjustment if necessary.

It is recommended to operate with the stability LED turned ON.

TEST FUNCTION (S6/S6T-5-G)

The TEST+ and TEST- inputs can be used to inhibit the emitter and verify that the system is correctly operating.

The receiver output should switch when the test is activated while the beam is uninterrupted. The inputs activating voltage range is 10 ... 30 Vdc, whilst respecting the polarity.

ALARM FUNCTION (S6/S6T-5-F)

The alarm output switches ON whenever the received signal remains without a safety margin (greater than 30% compared to the output switching level) for longer than 3 seconds.

DECLARATION OF CONFORMITY

We DATALOGIC AUTOMATION declare under our sole responsibility that these products are conform to the 2004/108/CE and successive amendments.



WARRANTY

DATALOGIC AUTOMATION warrants its products to be free from defects.

DATALOGIC AUTOMATION will repair or replace, free of charge, any product found to be defective during the warranty period of 36 months from the manufacturing date.

This warranty does not cover damage or liability deriving from the improper application of DATALOGIC AUTOMATION products.

DATALOGIC AUTOMATION

Via Lavino 265 - 40050 Monte S.Pietro - Bologna - Italy

Tel: +39 051 6765611 - Fax: +39 051 6759324

www.automation.datalogic.com e-mail: info.automation@datalogic.com

DATALOGIC AUTOMATION cares for the environment: 100% recycled paper. DATALOGIC AUTOMATION reserves the right to make modifications and improvements without prior notification.

Datalogic and the Datalogic logo are registered trademarks of Datalogic S.p.A. in many countries, including the U.S.A. and the E.U.