



S67

Accurate and precise laser distance sensor with submillimetric resolution

- Sturdy metal Die-cast zinc IP67 housing.
- Resolution of 10um@50mm. distance on white 90% remission.
- Response time less than 0,9ms (short range models)
- Linearity error of +/- 0,03mm@50mm range.
- Analog Voltage models with 0V-10V protected output.
- Analog Current models with 4-20mA protected output.
- Soiling indicator and Alarm Output.
- Robust light interference suppression.

APPLICATIONS

- Automotive Industries
- Textile and Paper Industries
- Wood Industries
- General Packaging Industries
- Metal tooling
- Assembly lines
- Mechanical engineering and Special machinery



SENSORS

S67		
Distance sensor (90% White target)		50...300 mm (Y03) 100...600 mm (Y13)
Linearity error:		±0.03...±1.0 mm (Y03) ±0.05...±2.0 mm (Y13)
Resolution:		0.01...0.33 mm (Y03) 0.015...0.67 mm (Y13)
Laser class emission:		RED Laser Diode CLASS 2 According to IEC 60825-1 (2014)
Response time:		< 900 µs long range
Setting		Red LED Alarm/Soiled lens indicator Green LED Power indicator Push Button Teach in
Power supply:	Vdc	12-28 VDC +/- 10%
	PNP	-
	NPN	-
	Push pull	-
	other	Analog output: 4...20 mA (-I) 0...10 V (-V)
Connection	connector	Rotatable M12 5poles
Approximate dimensions (mm)		Rectangular 20,6mm x 65mm x 50mm
Housing material		die-cast zinc
Mechanical protection		IP67

TECHNICAL DATA	
Power supply	12 -28 VDC +/- 10%
Consumption (output current excluded)	100 mA
Light emission	650 nm Pulsed RED Laser Diode CLASS 2 According to IEC 60825-1 (2014) Complies with 21 CFR 1040.10 and 1040.11
Laser Spot	2 mm Point
Setting	Push Button Teach in
Operating Distance (90% White target)	50...300 mm (Y03) 100...600 mm (Y13)
Linearity error (90% White target)	±0.03...±1.0 mm (Y03) ±0.05...±2.0 mm (Y13)
Resolution (90% White target)	0.01...0.33 mm (Y03) 0.015...0.67 mm (Y13)
Teach-in Range min.	>5mm (Y03) >10mm (Y13)
Indicators	Red LED Alarm/Soiled lens indicator Green LED Power indicator Push Button Teach in
Analog output	Analog Current Output : load resistance (analog I) < (+Vs - 6 V) / 0,02 (-I) Analog Voltage Output : load resistance > 100 kOhm (-V)
Response time	< 900 µs long range
Connection	Rotatable M12 5poles
Dielectric strength	500 Vac, 1 min between electronics and housing
Insulating resistance	>20 MΩ, 500 Vdc between electronics and housing
Mechanical protection	IP67
Ambient light rejection	< 8k Lux (Y03) < 10k Lux (Y13)
Vibrations	0,5 mm amplitude, 10 ... 55 Hz frequency, for every axis (EN60068-2-6)
Shock resistance	11 ms (30 G) 6 shock for every axis (EN60068-2-27)
Housing material	die-cast zinc
Lens material	Glass
Typ. Temperature Drift	± 0.03% of Full Scale Measuring Range / °C
Operating temperature	0...50°C
Storage temperature	-25 ... 70 °C
Tightening torque	1.0 Nm
Weight	180g. max.

DIMENSIONS

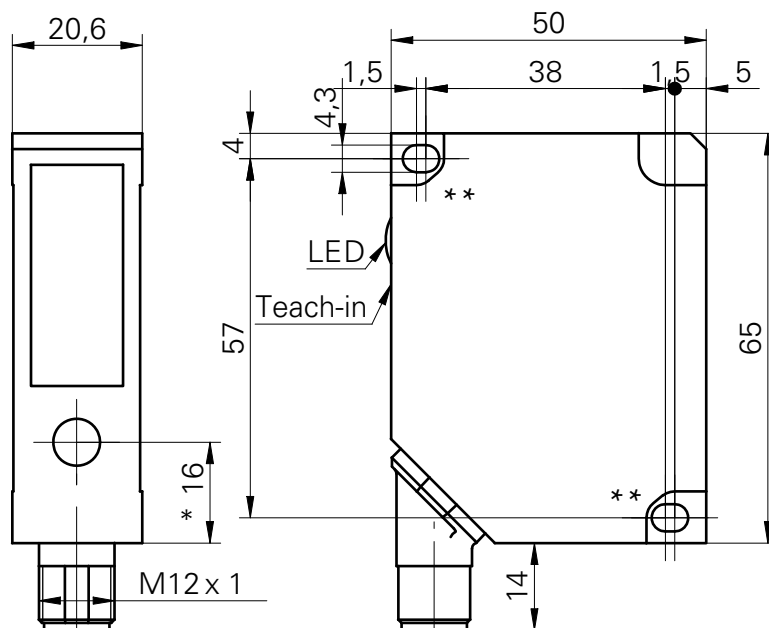

* emitter axis

**Apply tighten torque...<1.0 Nm

CONNECTIONS

S67-MH-5-Y03-I / S67-MH-5-Y13-I

1. (BROWN): +12...28 VDC
2. (WHITE): ANALOGUE OUTPUT- I(4...20mA)
3. (BLUE): 0V
4. (BLACK): NOT USED
5. (GREY): TEACH IN

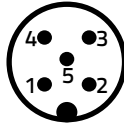

S67-MH-5-Y03-V / S67-MH-5-Y13-V

1. (BROWN): +12...28 VDC
2. (WHITE): ANALOGUE OUTPUT- I(0...10mA)
3. (BLUE): 0V
4. (BLACK): NOT USED
5. (GREY): TEACH IN

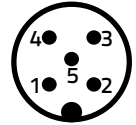

Note: If external Teach-In option is not used, the Teach-In wire must be attached to GND.

Note: Shielded cable is suggested for critical cabling.

Note: Color of wires are referred to European standard.

INDICATORS AND SETTINGS

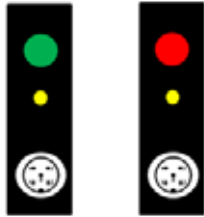

LEDS

RED LED may indicate ALARM or dirty lens surface.
GREEN LED is the POWER indicator.

TEACH IN BUTTON

The yellow button allows the user to teach a new range by optimizing the resolution. It can be used to reset the factory settings.

The S67Y distance sensor is factory set to the maximum measuring range. In order to optimize the resolution and linearity, its Teach-In feature is designed to select a smaller range within the nominal range. If a new range is chosen the Output current, voltage and alarm output will adapt to it.

The sensor must be taught with two specific positions:

- First Teach-In: aligns the position with 0 V (or 4 mA)
- Second Teach-In: aligns the position with 10 V (or 20 mA)

Note: The two positions are always at the border of the new range (within the measuring range).

The red LED gives feedback during a Teach-In session. The red LED located on the back of the sensor, indicates 'Run' mode if it detects an object in the measuring range. The S67Y can be set in two different ways: one with Teach-In button and the other one through the external teach input.

The device can be taught more than 10.000 times in its lifetime. The S67Y may be always reset to factory setup.

TEACHING NEW MEASURE	RESET
<p>Seven steps to teaching a new measuring range:</p> <ol style="list-style-type: none"> 1. Press (and hold) the button. The red LED will turn on, if the sensor can be taught. 2. Hold down the button for 5 more sec. The LED will start to blink. 3. Release the button. 4. Place a target at the first new position of the measuring range. This is the position that will later produce 0 V (or 4 mA). 5. Briefly press the button again. The LED will stop blinking and will stay on for about 3 sec to indicate that the first position has been stored. Then the LED will blink again. 6. Now place the target at the second position (the other end of the new range), which will produce 10 V (or 20 mA). 7. Briefly press the button again. The LED will stop blinking and will stay on for about 3 sec to indicate that the second position has been stored. The LED will then turn off and blink once more. <p>Now the sensor is ready to measure.</p> <p>The new, smaller operating range is now set. The red LED now indicates whether an object is within the new range (LED OFF) or not (LED ON). If one of the new borders of the range was outside the standard range or the two positions were too close to each other, then the new settings are not valid. The sensor will respond with an extended blinking at the end of the teach procedure. The previous settings are still valid and the new settings are lost</p>	<ol style="list-style-type: none"> 1. Push the button. The red LED will turn on, if the sensor can be taught. 2. Hold down the button further 5 sec. The LED will start to blink. Do not release the button now. Wait another 10 sec until the LED is ON without blinking. Factory settings have been restored to the sensor. 3. Release the button. <p>Note: If there are missed measurements (up to 30 cycles) these will be suppressed. During this time the analog output stays on hold. Note: For objects with a reflectivity < 7 % (S67-MR-5-Y13...), the response/release time is increased automatically up to max. 2.8 ms.</p>

DETECTION DIAGRAMS

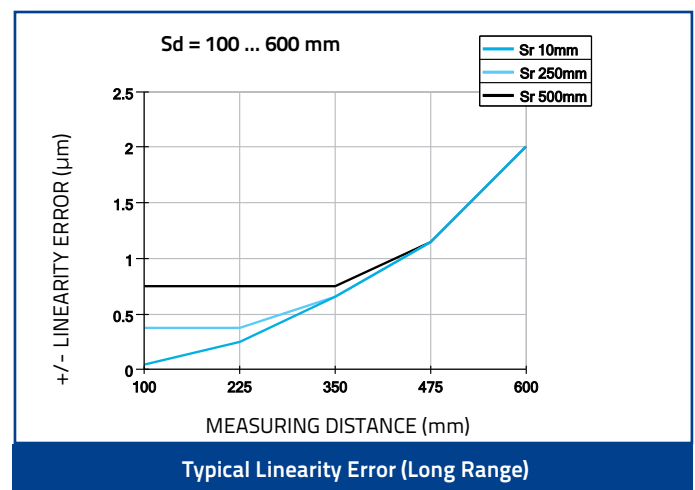
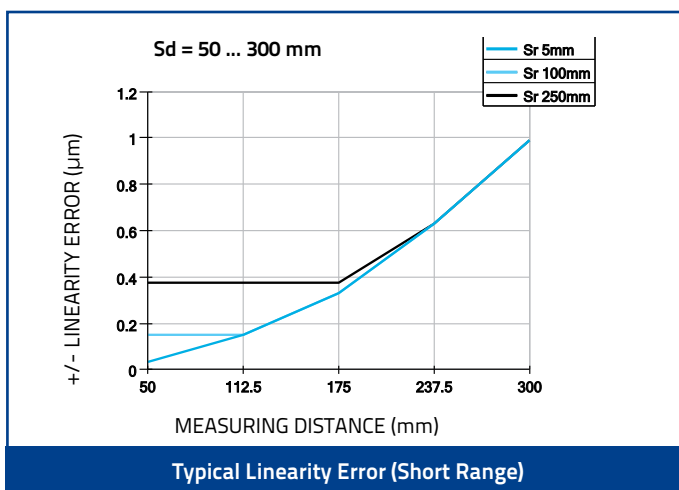
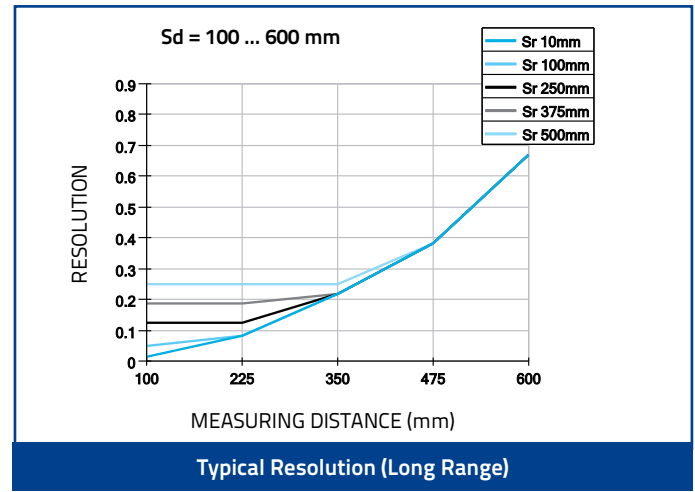
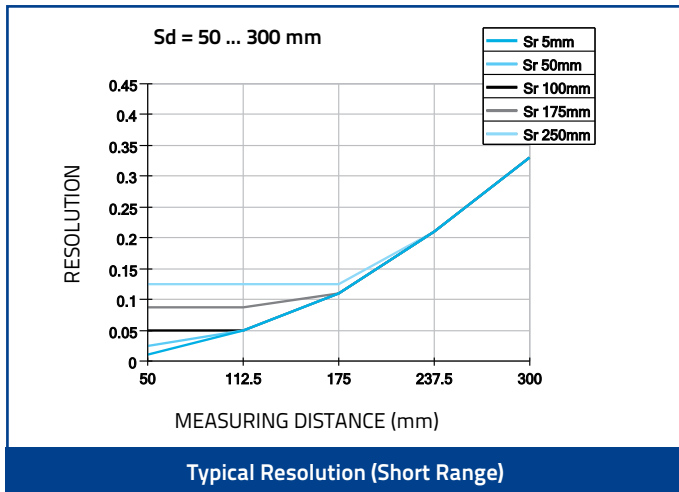
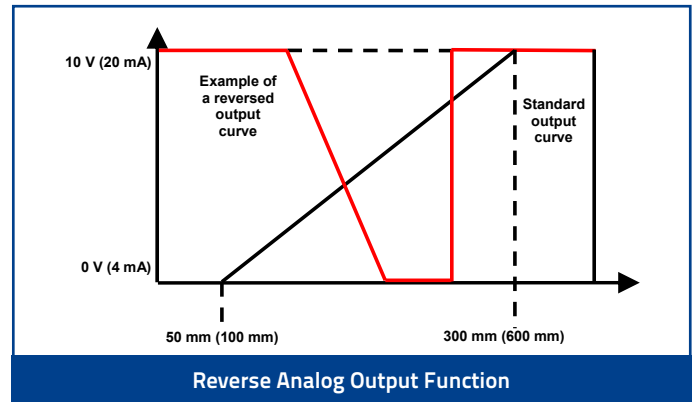
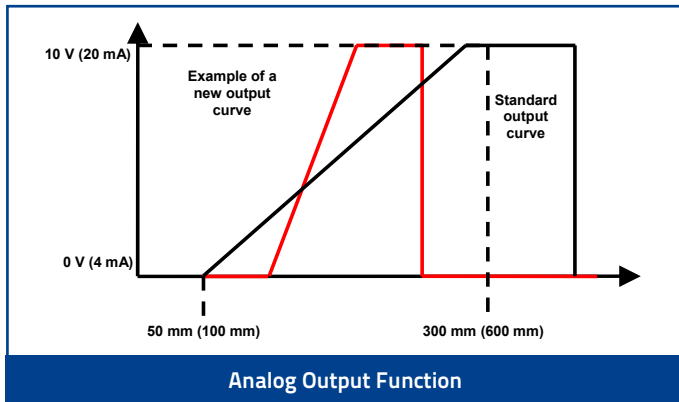

MODEL SELECTION AND ORDER INFORMATION

OPTIC FUNCTION	OPERATING DISTANCE	CONNECTION	OUTPUT & INPUT	MODELS	ORDER No.
Long range Laser Distance Sensor	100...600 mm	M12 5-poles connector	Analog output: 0...10 V (-V)	S67-MH-5-Y13-V	956271030
			Analog output: 4...20 mA (-I)	S67-MH-5-Y13-I	956271010
Short range Laser Distance Sensor	50...300 mm	M12 5-poles connector	Analog output: 0...10 V (-V)	S67-MH-5-Y03-V	956271020
			Analog output: 4...20 mA (-I)	S67-MH-5-Y03-I	956271000

ACCESSORIES

S67Y mounting kit

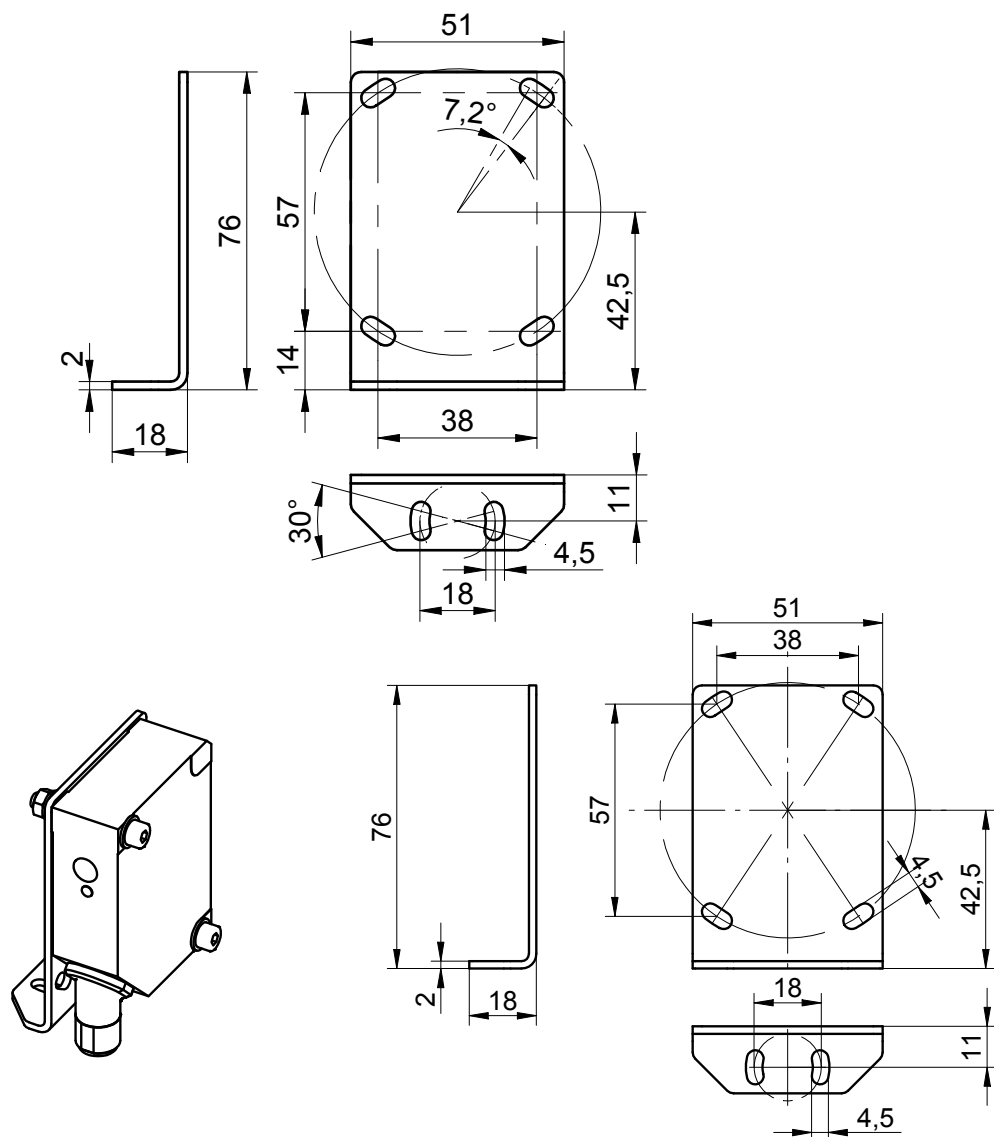

MODEL	DESCRIPTION	ORDER No.
ST-S67Y	S67Y mounting kit	9CA5C8160

CABLES

TYPE	DESCRIPTION	LENGTH	MODEL	ORDER No.
Axial M12 connector	5-pole, grey, P.V.C.	3 m	CS-A1-03-G-03	95ACC2110
		5 m	CS-A1-03-G-05	95ACC2120
		10 m	CS-A1-03-G-10	95ACC2140
	5-pole, U.L., black, P.V.C	3 m	CS-A1-03-U-03	95ASE1170
		5 m	CS-A1-03-U-05	95ASE1180
		10 m	CS-A1-03-U-10	95ASE1190