

S62 SERIES

S62 photoelectric sensor line offers compact dimensions and competitive prices for all basic and advanced models.

All universal optic functions are available at best performances in the standard 50x50x18 mm compact plastic housing with IP67 mechanical protection.

Laser emission models for high resolution detection are also available for polarized retroreflex, diffuse proximity and background suppression. S62 allows a great versatility of installations with Vac/dc multivoltage power supply and SPDT relay output, as well as 10-30 Vdc version with NPN/ PNP configurable output or NO-NC standard outputs. The connection is available with 2 m cable or M12 4-poles rotatable connector.

S62 series is the first choice when looking for a photoelectric sensor with the best price / performance ratio in a compact standard case.



HIGHLIGHTS

- High-resolution sensors with **LED** or **LASER** emission
- High installation flexibility
- Background suppression, retroreflex polarized and diffuse proximity Laser versions
- **Vac/dc** multivoltage version
- Sensitivity/distance adjustment trimmer
- **Cable** or **M12 rotatable connector**
- PNP, NPN, PNP/NPN or SPDT Relay output

APPLICATIONS

Ceramics

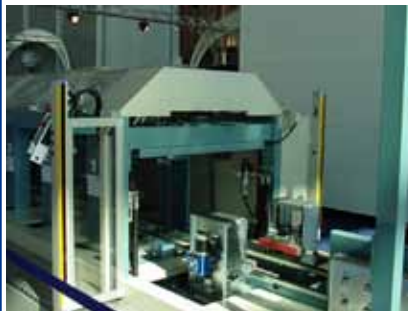

Transportation lines



Beverage & Bottling



Packaging lines



The background suppression proximity can set very precisely the limit over which the object is not detected, with minimum differences also between objects with material or colour differences. The threshold switching adjustment is easier and more precise thanks to the multiturn mechanical trimmer and the gear numeric scale. The polarised retroreflex, thanks to high-polarisation optic filters, detects very reflective objects even with mirror surfaces, that however do not rotate the polarisation plane of the reflected light, like the prismatic reflector.

DIMENSIONS

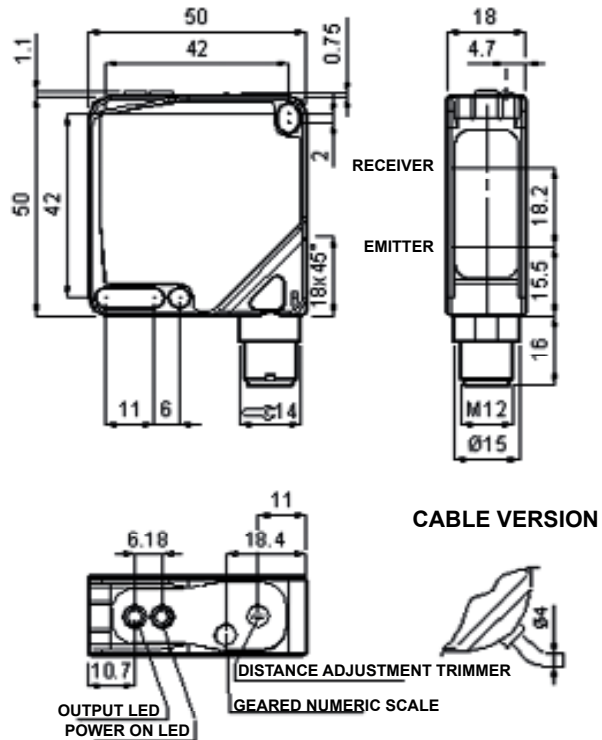

INDICATORS AND SETTINGS

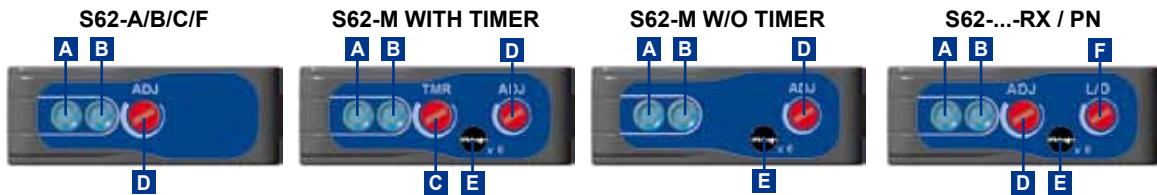

- A** Output status LED
- B** Stability LED or Power ON LED (laser vers.)
- C** Timer adjustment trimmer
- D** Distance adjustment trimmer
- E** Geared numeric scale
- F** Light / Dark selection trimmer

CONNECTIONS

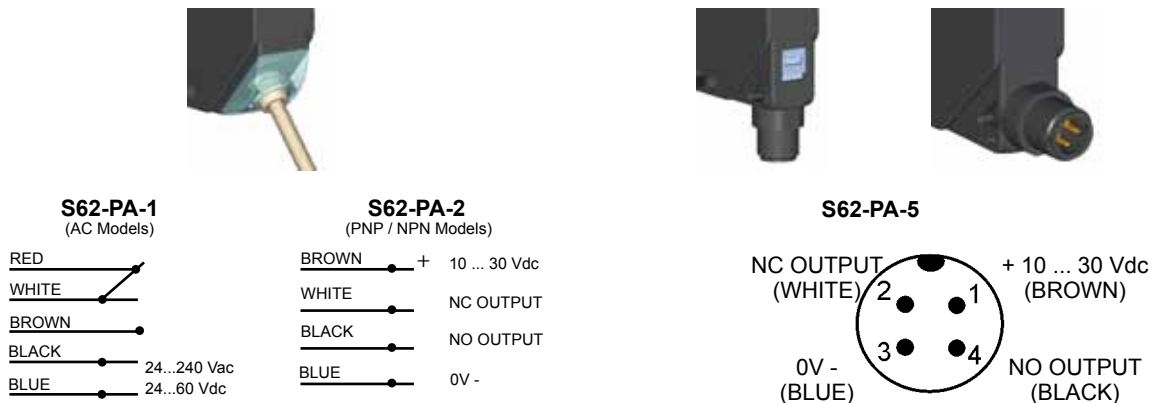

TECHNICAL DATA

	S62-PA-2/5 LED/LASER Vdc	S62-PA-1 LED Vac/dc
Power supply	10 ... 30 Vdc	24...240 Vac/ 24...60 Vcc
Ripple	≤ 2 Vpp	10% max
Current Consumption	<30 mA	< 3 VA
Output current	≤ 100 mA (overload and overvoltage protection)	2A max (resist load)
Saturation voltage	≤ 2 V	-
Emission type	RED(640nm)(S62...A/B/C/G)	
Dielectric strength	500 Vac 1 min., between electronics and housing	
Insulation resistance	>20 MΩ 500 Vdc, between electronics and housing	
Mechanical protection	IP67	
Ambient light rejection	According to EN 60947-5-2	
Vibrations	0.5 mm amplitude, 10 ... 55 Hz frequency, for each axis (EN60068-2-6)	
Shock resistance	11ms (30G) 6 shock for every axis (EN60068-2-27)	
Housing	ABS	
Indicators	OUTPUT LED (yellow)/STABILITY LED(green)	
	S62...G (emitter): POWER LED(green)	
Adjustment	Sensitivity adjustment trimmer	
	Mono-turn light/dark trimmer(S62...RX/PN)	
Timing function	0...1 s (DELAY off)	
Connection	Cable vers.: 2 m Ø 4 mm	
	Cable vers.: 2 m Ø 5 mm (AC version)z	
	Connector vers.: M12 4-pole connector	
Lens material	PMMA window, polycarbonate lens	
Weight	40 g max mod. M12	
	90 g max mod. cable	
Operating temperature	-10...+55°C	
Storage temperature	-20...+70°C	
UL requirements	VDC models: they are intended to be connected to a Class 2 transformer or class 2 power supply. VAC models: these devices shall be connected to a powersupply or system,including filters or air-gaps, of overvoltage category II ("load level – secondary circuit of a protected utility transformer"), suitable to control over-voltages at the maximum "rated impulse withstand voltage peak of 1.2KV and with a short-circuit power limit at max 500VA.	

EMISSION TYPE

The very low black/white difference of background suppression sensors allows to detect a dark-coloured target presence, or absence, even onto a light-coloured very reflective background. However, if the target is much smaller than the light spot and smaller than the background area, the detection can be critical either for the low resolution and for the 'cross-eyed effect' (excessive light reflected by the background).

The narrow collimated light beam of the **S62** LASER background suppression sensor is the right solution able to offer the requested resolution and avoid the cross-eyed effect, thus permitting the detection of the smallest objects or their minimal movements, even in presence of large and reflective background area. The LASER polarised retroreflex sensor of the **S62** series, as well as increasing the maximum operating distance, offers the improvement of the detection resolution thanks to the smaller dimensions of the light beam respect to the LED emission beam.

Basically, the minimum detectable dimension corresponds to the emission beam diameter at the detection distance. The maximum resolution can be obtained only with micropismatic reflectors (0.8 mm microcubes), such as the small **R8** suitable for short distances up to 2 m, or the **R7** and **R20** models for distance up to 22 m.

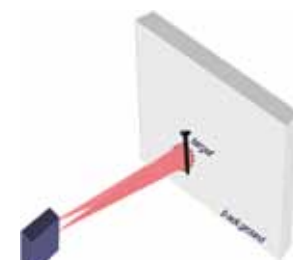
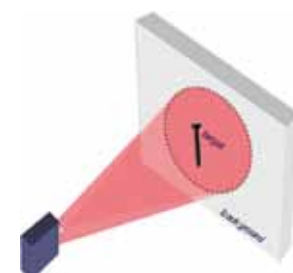

TECHNICAL DATA OF MODELS WITH LED EMISSION

OPTIC FUNCTION	EMISSION	OPERATING DISTANCE	CONNECTION	SETTING	OUTPUT	SWITCH FREQUENCY	RESPONSE TIME
non-polarised retroflex	LED red (640nm)	0,1 ... 13m	Vac cable	mono-turn light/dark trimmer	relay	20 Hz	25 ms
			cable	sensitivity trimmer (mono turn)	PNP/NPN*	1 kHz	500 µs
			connector M12		PNP/NPN*		
polarised retroflex	LED red (640nm)	0,1 ... 8m (on R2 reflector)	Vac cable	mono-turn light/dark trimmer	relay	20 Hz	25 ms
			cable	sensitivity trimmer (mono-turn)	PNP	1 kHz	500 µs
			connector M12		PNP/NPN*		
					PNP		
NPN							
diffuse proximity	LED red (640nm)	0 ... 90cm (S62-...-C01)	Vac cable	mono-turn light/dark trimmer	relay	20 Hz	25 ms
			cable	sensitivity trimmer (mono-turn)	PNP/NPN*		
			connector M12		PNP		
		NPN					
		PNP/NPN*					
		PNP					
	NPN						
	0 ... 200cm (S62-...-C11)	Vac cable	mono-turn light/dark trimmer	relay	1 kHz	500 µs	
		cable	sensitivity trimmer (mono turn)	PNP/NPN*			
		connector M12		PNP			
				NPN			
				PNP/NPN*			
PNP							
NPN							
through beam receiver	(receiver)	0 ... 25m	Vac cable	mono-turn light/dark trimmer	relay	20 Hz	25 ms
			cable	sensitivity trimmer (mono turn)	PNP/NPN*	500 Hz	1 ms
			connector M12		PNP		
					NPN		
					PNP/NPN*		
			PNP				
NPN							
through beam emitter	LED red (640nm)	0 ... 25m	Vac cable	sensitivity trimmer (mono turn)	///	20 Hz	25 ms
			cable		Test + Test -	500 Hz	1 ms
			connector M12				
background suppression	LED red (640nm)	30 ... 300mm (S62-...-M01)	cable	multidistance adjustment trimmer	PNP/NPN*	1 kHz	500 µs
			connector M12		PNP		
					PNP/NPN*		
		PNP					
		timer adjustment trimmer	PNP				
			NPN				
	PNP						
	60 ... 600mm (S62-...-M1x)	cable	multidistance adjustment trimmer	PNP	500 Hz	1 ms	
		connector M12		PNP			
				NPN			
	timer adjustment trimmer			PNP			
		NPN					
PNP							
LED infrared (880nm)	60 ... 1200mm (S62-...-M21)	cable	multidistance adjustment trimmer	PNP	330 Hz	1,5 ms	
		connector M12		PNP			
				NPN			
	timer adjustment trimmer			PNP			
		NPN					
		PNP					
200 ... 2000mm (S62-...-M3x)	cable	multidistance adjustment trimmer	PNP	330 Hz	1,5 ms		
	connector M12		PNP				
			NPN				
timer adjustment trimmer			PNP				
	NPN						
	PNP						

* L / D Selection trimmer



DETECTION DIAGRAMS OF MODELS WITH LED EMISSION

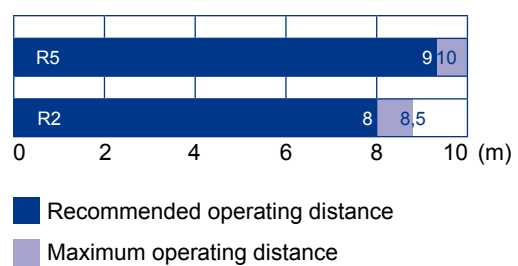
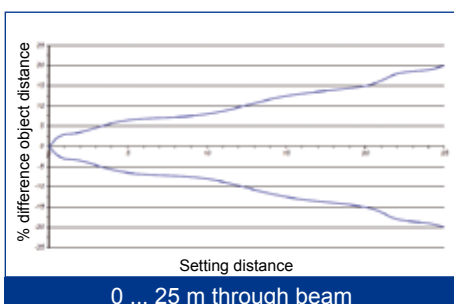
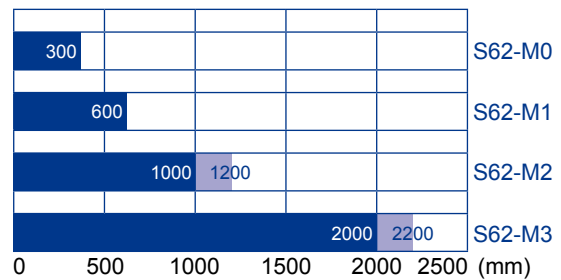
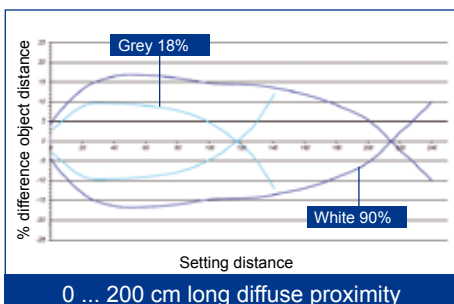
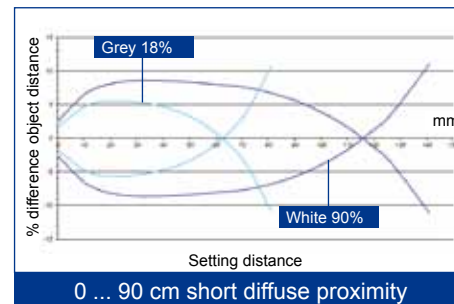
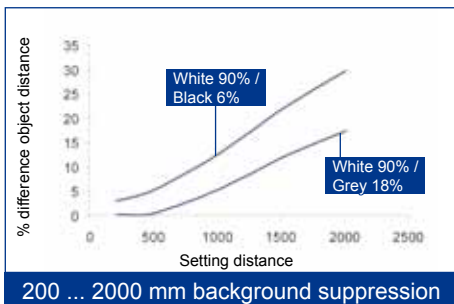
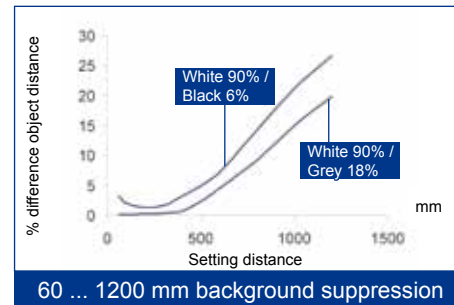
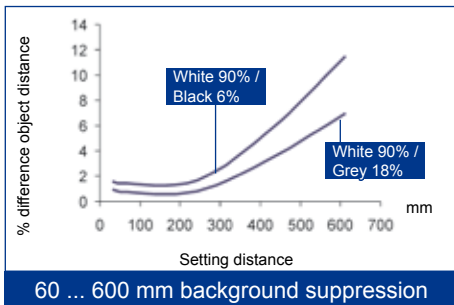
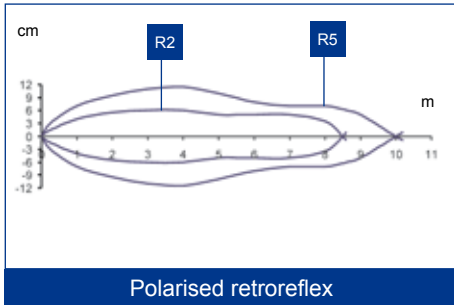

TECHNICAL DATA OF MODELS WITH LASER EMISSION

RED LASER ($\lambda=645\dots665\text{nm}$); Class 2 EN 60825-1, Class II CDRH 21 CFR PART 1040.10.
Pulsed emission: pot. max $\leq 5\text{mW}$; pulse duration = $5\mu\text{s}$; frequency max = 32KHz

OPTIC FUNCTION	EMISSION	OPERATING DISTANCE	CONNECTION	SETTING	OUTPUT	SWITCH FREQUENCY	RESPONSE TIME
polarised retroflex	LASER	0,3 ... 20 m (on R2 reflector)	connector M12	sensitivity trimmer (mono-turn)	PNP	2,5k Hz	200 μs
					NPN		
diffuse proximity	LASER	0 ... 90 cm	cable	sensitivity trimmer (mono turn)	PNP	1k Hz	500 μs
			connector M12		NPN		
background suppression	LASER	30 ... 150 mm (S62-...-M01)	connector M12	4 turn distance trimmer	PNP	3,5k Hz	140 μs
		50 ... 350 mm (S62-...-M11)		6 turn distance trimmer	PNP		
					NPN		



DETECTION DIAGRAMS OF MODELS WITH LASER EMISSION

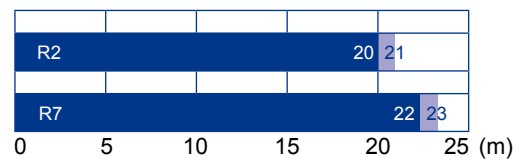
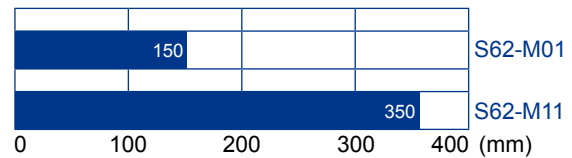
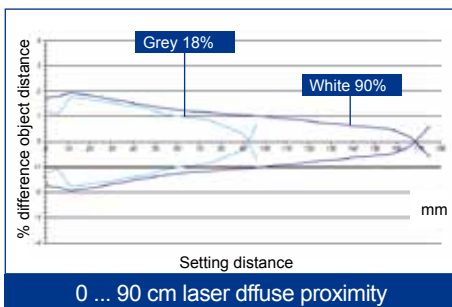
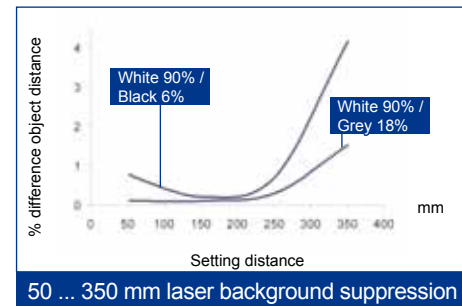
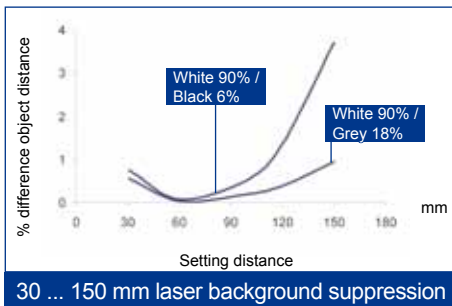
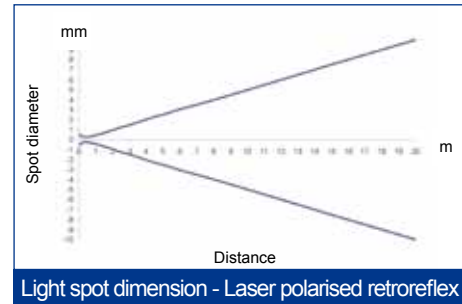
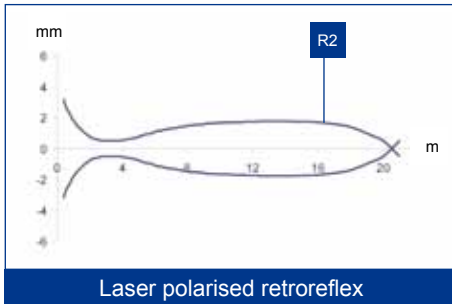

Reflector operating distances (m)				
R1	R2	R6	R7 / R20	R8
0.3 ... 16	0.3 ... 20	0.4 ... 22	0.3 ... 22	0.2 ... 2

The use of the RT3970 reflecting tape is suggested.

Recommended operating distance
 Maximum operating distance

MODEL SELECTION AND ORDER INFORMATION

OPTIC FUNCTION	EMISSION	CONNECTION	SETTING	OUTPUT	MODEL	ORDER NO.		
non-polarised retroflex	LED red (640nm)	Vac cable	mono-turn light/dark trimmer	relay	S62-PA-1-A01-RX	956211180		
		cable	sensitivity trimmer (mono turn)	PNP/NPN*	S62-PA-2-A01-PN	956211240		
		connector M12		PNP/NPN*	S62-PA-5-A01-PN	956211310		
polarised retroflex	LED red (640nm)	Vac cable	mono-turn light/dark trimmer	relay	S62-PA-1-B01-RX	956211190		
		cable	sensitivity trimmer (mono-turn)	PNP	S62-PA-2-B01-PP	956211010		
				PNP/NPN*	S62-PA-2-B01-PN	956211250		
		connector M12		PNP	S62-PA-5-B01-PP	956211110		
				NPN	S62-PA-5-B01-NN	956211020		
		LASER		connector M12	PNP/NPN*	S62-PA-5-B01-PN	956211320	
	PNP				S62-PL-5-B01-PP	956211110		
	NPN	S62-PL-5-B01-NN	956211100					
diffuse proximity (0...90 cm)	LED red (640nm)	Vac cable	mono-turn light/dark trimmer	relay	S62-PA-1-C01-RX	956211200		
		cable	sensitivity trimmer (mono-turn)	PNP/NPN*	S62-PA-2-C01-PN	956211260		
				PNP	S62-PA-2-C01-PP	956211380		
		connector M12		NPN	S62-PA-2-C01-NN	956211420		
				PNP/NPN*	S62-PA-5-C01-PN	956211330		
		LASER		connector M12	PNP	S62-PA-5-C01-PP	956211460	
					NPN	S62-PA-5-C01-NN	956211500	
		diffuse proximity (0...200 cm)		LED red (640nm)	Vac cable	mono-turn light/dark trimmer	relay	S62-PA-1-C11-RX
cable	sensitivity trimmer (mono turn)				PNP/NPN*	S62-PA-2-C11-PN	956211270	
			PNP		S62-PA-2-C11-PP	956211390		
connector M12			NPN		S62-PA-2-C11-NN	956211430		
			PNP/NPN*		S62-PA-5-C11-PN	956211340		
LASER			connector M12		PNP	S62-PA-5-C11-PP	956211470	
					NPN	S62-PA-5-C11-NN	956211510	
diffuse proximity (0...90 cm)			LASER		connector M12		PNP	S62-PL-2-C01-PP
		NPN		S62-PL-2-C01-NN			956211440	
	PNP	S62-PL-5-C01-PP		956211480				
	NPN	S62-PL-2C01-NN		956211520				
through beam receiver	(receiver)	Vac cable	mono-turn light/dark trimmer	relay	S62-PA-1-F01-RX	956211220		
		cable	sensitivity trimmer (mono turn)	PNP/NPN*	S62-PA-2-F01-PN	956211290		
				PNP	S62-PA-2-F01-PP	956211410		
		connector M12		NPN	S62-PA-2-F01-NN	956211450		
				PNP/NPN*	S62-PA-5-F01-PN	956211360		
		LASER		connector M12	PNP	S62-PA-5-F01-PP	956211490	
					NPN	S62-PA-5-F01-NN	956211530	
		through beam emitter		LED red (640nm)	Vac cable	sensitivity trimmer (mono turn)	///	S62-PA-1-G00-XX
cable	Test + Test -				S62-PA-2-G00-XG		956211300	
connector M12	Test + Test -		S62-PA-5-G00-XG		956211370			
background suppression (30...300 mm)	LED red (640nm)	cable	multidistance adjustment trimmer	PNP	S62-PA-2-M01-PP	956201841		
				PNP/NPN*	S62-PA-2-M01-PN	956211280		
		connector M12		PNP/NPN*	S62-PA-5-M01-PN	956211350		
				PNP	S62-PA-5-M01-PP	956201831		
		LASER		connector M12	NPN	S62-PA-5-M01-NN	956201811	
					PNP	S62-PA-5-M05-PP	956201821	
background suppression (60...600 mm)	LED red (640nm)	cable	multidistance adjustment trimmer	NPN	S62-PA-5-M05-NN	956201801		
				PNP	S62-PA-2-M11-PP	956201891		
		connector M12		PNP	S62-PA-5-M11-PP	956201881		
				NPN	S62-PA-5-M11-NN	956201861		
		LASER		connector M12	PNP	S62-PA-5-M15-PP	956201871	
					NPN	S62-PA-5-M15-NN	956201851	
background suppression (60...1200 mm)	LED infrared (880nm)	cable	multidistance adjustment trimmer	PNP	S62-PA-2-M21-PP	956201940		
				PNP	S62-PA-5-M21-PP	956201900		
		connector M12		NPN	S62-PA-5-M21-NN	956201910		
				PNP	S62-PA-5-M25-PP	956201920		
		LASER		connector M12	NPN	S62-PA-5-M25-NN	956201930	
					PNP	S62-PA-2-M31-PP	956211050	
background suppression (200...2000 mm)	LED infrared (880nm)	cable	multidistance adjustment trimmer	PNP	S62-PA-5-M31-PP	956211070		
				NPN	S62-PA-5-M31-NN	956211060		
		connector M12		PNP	S62-PA-5-M35-PP	956211090		
				NPN	S62-PA-5-M35-NN	956211080		
		LASER		connector M12	4 turn distance trimmer	PNP	S62-PL-5-M01-PP	956211130
					NPN	S62-PL-5-M01-NN	956211120	
LASER	connector M12	6 turn distance trimmer	PNP	S62-PL-5-M11-PP	956211150			
			NPN	S62-PL-5-M11-NN	956211140			

* L / D Selection trimmer

ACCESSORIES

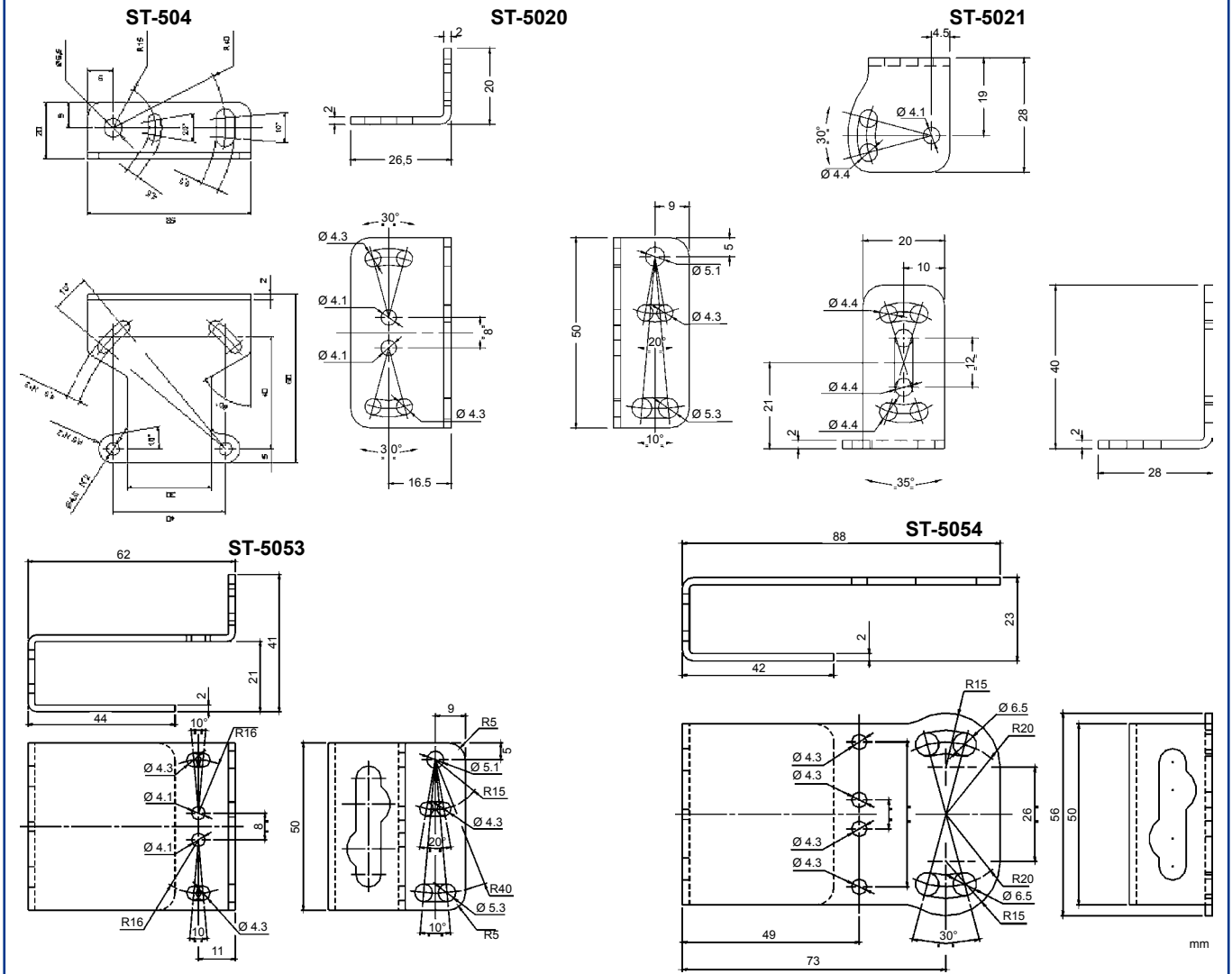

Joint-62: as ST-5054 with jointed support

ACCESSORY SELECTION AND ORDER INFORMATION

DESCRIPTION	MODEL	ORDER N°
Ø 23 mm prismatic reflector with Ø 31 mm support	R1	S940700023
Ø 48 mm prismatic reflector with Ø 63 mm support	R2	S940700048
36 x 55 mm prismatic reflector with 40.5 x 60 mm support	R6	95A151350
38 x 40 mm microprism reflector with 51 x 60.7 mm support	R7	95A151360
9.7 x 19 mm microprism reflector with 13.8 x 23 mm support	R8	95A151370
Ø 48 mm prismatic reflector with Ø 63 mm support	R20	95A151090
protection bracket with jointed support	JOINT-S62	95ACC2430
fixing bracket	ST-504	95ACC2820
fixing bracket	ST-5020	95ACC5330
fixing bracket	ST-5021	95ACC5340
protection bracket	ST-5053	95ACC2410
protection bracket	ST-5054	95ACC2420



The company endeavours to continuously improve and renew its products; for this reason the technical data and contents of this catalogue may undergo variations without prior notice. For correct installation and use, the company can guarantee only the data indicated in the instruction manual supplied with the products.