

RTR 3B

Energetic diffuse reflection light scanner

en 05-2014/05 50108962-01



Dimensioned drawing

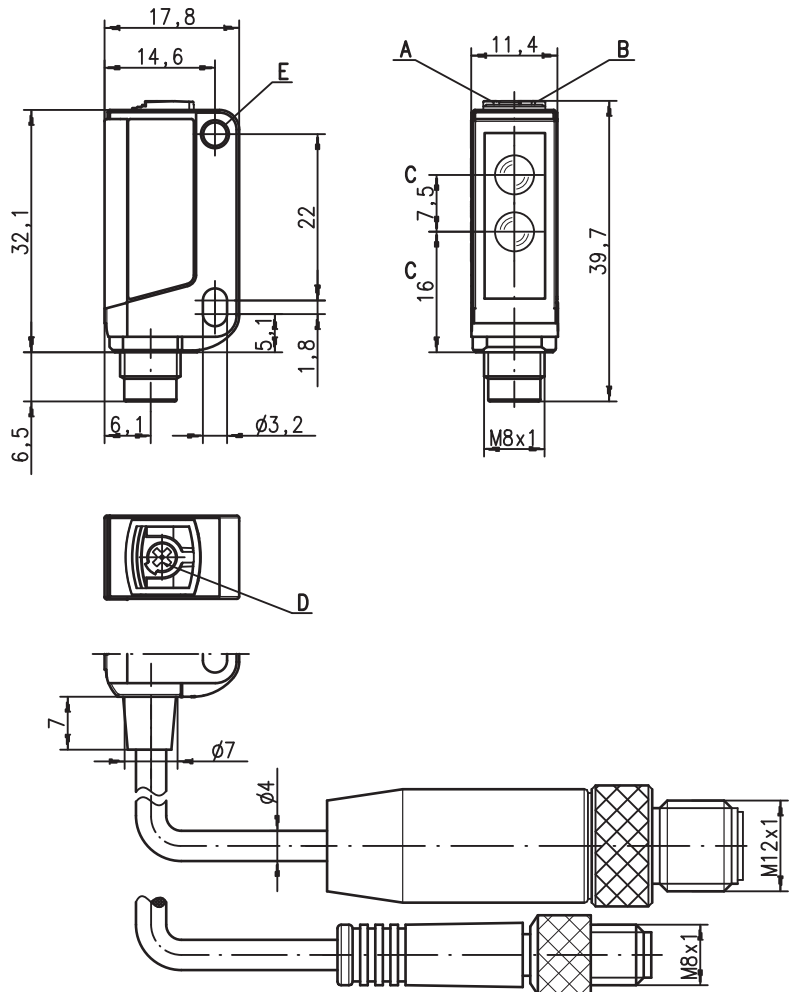

- A Green indicator diode
- B Yellow indicator diode
- C Optical axis
- D Potentiometer for scanning range adjustment
- E Attachment sleeve

0 ... 750mm

- Energetic diffuse reflection light scanner with scanning range adjustment
- Visible red light
- Small and compact construction with robust plastic housing, protection class IP 67 for industrial application
- Fast alignment through *brightVision*®
- A²LS- Active Ambient Light Suppression
- Push-pull switching output
- High switching frequency for detection of fast events
- Low current consumption

Electrical connection

Plug connection, 4-pin

10-30V DC +	1	br/BN
OUT 2	2	ws/WH
GND	3	bl/BU
OUT 1	4	sw/BK

Cable, 4-wire

10-30V DC +	br/BN
OUT 2	ws/WH
GND	bl/BU
OUT 1	sw/BK

Accessories:

(available separately)

- Mounting systems (BT 3...)
- Cable with M8 or M12 connector (K-D ...)

We reserve the right to make changes • DS_RTR3B_en_50108962_01.fm

Specifications

Optical data

Typ. scanning range limit ¹⁾	0 ... 750mm
Scanning range ²⁾	see tables
Adjustment range ¹⁾	0 ... 700mm
Light source ³⁾	LED (modulated light)
Wavelength	620nm (visible red light)

Timing

Switching frequency	1,000Hz
Response time	0.5ms
Delay before start-up	≤ 300ms

Electrical data

Operating voltage U_B ⁴⁾	10 ... 30VDC (incl. residual ripple)
Residual ripple	≤ 15% of U_B
Open-circuit current	≤ 10mA
Switching output/function ⁵⁾	2 push-pull switching outputs pin 2: PNP light switching, NPN dark switching pin 4: PNP dark switching, NPN light switching
	1 push-pull switching output pin 2: not connected; pin 4: PNP light switching, NPN dark switching
	1 NPN switching output pin 2: not connected; pin 4: NPN light switching
Signal voltage high/low	≥ ($U_B - 2V$) / ≤ 2V
Output current	max. 100mA
Scanning range	adjustable

Indicators

Green LED	ready (not for .7 types)
Yellow LED	Reflection (object detected)

Mechanical data

Housing	plastic (PC-ABS)
Optics cover	plastic (PMMA)
Weight (plug/cable)	10g/50g
Connection type	cable 2m (cross section 4x0.20mm ²), M8 connector, metal or plastic

Environmental data

Ambient temp. (operation/storage)	-30°C ... +55°C / -30°C ... +70°C
Protective circuit ⁶⁾	2, 3
VDE safety class	III
Protection class	IP 67
Light source	free group (in accordance with EN 62471)
Standards applied	IEC 60947-5-2
Certifications	UL 508, C22.2 No.14-13 ^{4) 7)}

- 1) Typ. scan. range limit/adjustment range: max. achievable scanning range/adjustment range for light objects (white 90%)
- 2) Scanning range: recommended scanning range for objects with different diffuse reflection
- 3) Average life expectancy 100,000h at an ambient temperature of 25°C
- 4) For UL applications: for use in class 2 circuits according to NEC only
- 5) The push-pull switching outputs must not be connected in parallel
- 6) 2=polarity reversal protection, 3=short-circuit protection for all transistor outputs
- 7) These proximity switches shall be used with UL Listed Cable assemblies rated 30V, 0.5A min, in the field installation, or equivalent (categories: CYJV/CYJV7 or PVVA/PVVA7)

Remarks

Adapter plate:

BT 3.2 (part no. 50103844) for alternate mounting on 25.4mm hole spacing (Omron E3Z, Sick W100...)

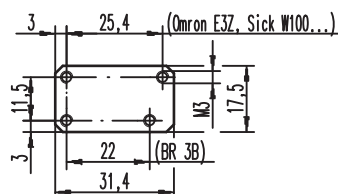

Tables

1	0	700	750
2	5	315	330
3	10	260	275

1	white 90%
2	gray 18%
3	black 6%

□	Scanning range [mm]
□	Typ. scanning range limit [mm]

Diagrams

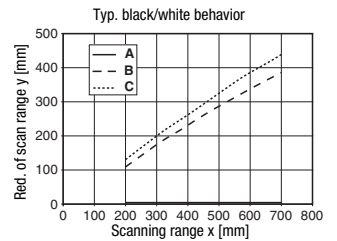

- A white 90%
- B gray 18%
- C black 6%

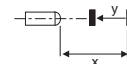

Remarks

Operate in accordance with intended use!

- ⚠ This product is not a safety sensor and is not intended as personnel protection.
- ⚠ The product may only be put into operation by competent persons.
- ⚠ Only use the product in accordance with the intended use.







- With the set scanning range, a tolerance of the scanning range limits is possible depending on the reflection properties of the material surface.
- Mounting system:



- ① = BT 3 (Part no. 50060511)
- ②+③ = BT 3.1 ¹⁾ (Part no. 50105585)
- ①+②+③ = BT 3B (Part no. 50105546)

1) Packaging unit: PU = 10 pcs.

RTR 3B
Energetic diffuse reflection light scanner
Order guide

Selection table			Order code →						
Equipment ↓			RTR 3B/66-S8 Part no. 50108505	RTR 3B/66 Part no. 50108506	RTR 3B/6.7-S8 Part no. 50109061	RTR 3B/6.7 Part no. 50109250	RTR 3B/2.7-S8 Part no. 50109065	RTR 3B/2.7 Part no. 50109251	
Output 1 (OUT 1)	push-pull switching output	 light switching	○	●	●	●	●		
		 dark switching	●						
	NPN transistor output	 light switching	○				●	●	
		 dark switching	●						
Output 2 (OUT 2)	push-pull switching output	 light switching	○						
		 dark switching	●	●	●				
	not assigned (pin 2), suitable for directly connecting to AS-i coupling module				●	●	●	●	
Connection	cable 2,000 mm	4-wire		●		●		●	
	M8 connector, metal	4-pin	●						
	M8 connector, plastic	4-pin			●		●		

