

RK46C VarOS

Retro-reflective sensors

en 02-2014/07 50125880

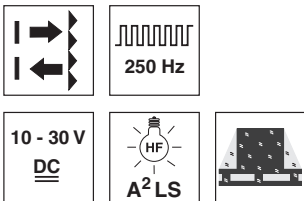

0.4 ... 5.2m

- Sensor with homogeneous light-band (red light) for reliable detection of objects with different sizes and shapes
- Teachable, preset sensitivity levels for time-saving, optimum adaptation to object size, shape and form
- *Easy tune* – calibration of the sensor to e.g. transparent, perforated or small objects
- Precise alignment thanks to the special shape and form of the light-band
- Maximum system availability through automatic readjustment of the performance reserve
- Reliable detection even with depolarizing media (e.g. foil packaging)
- Light/dark switching via the teach button

We reserve the right to make changes • DS\_RK46CDXL3\_en\_50125880.fm

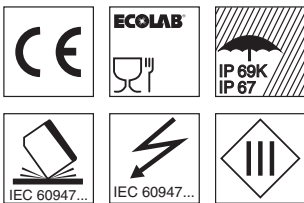

**Accessories:**

(available separately)

- Mounting systems (BT 46, BTU 300M, BTU 900M)
- M12 connectors (KD ...)
- Ready-made cables (K-D ...)
- Reflectors

**Dimensioned drawing**

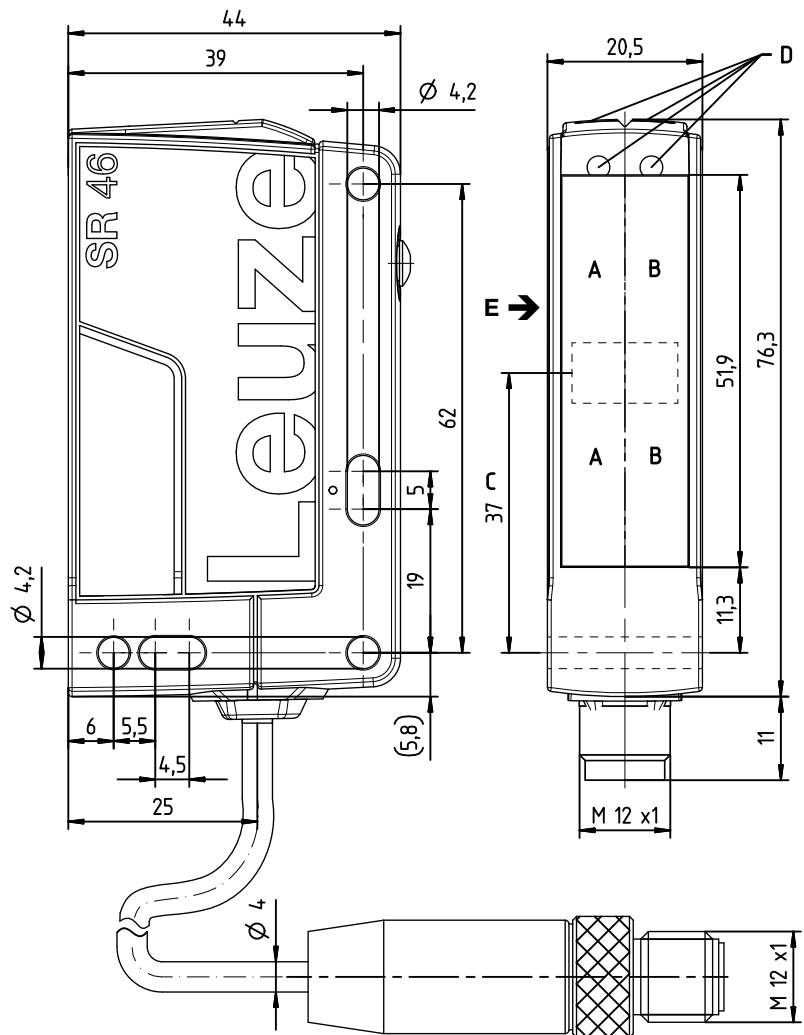

- A** Transmitter side
- B** Receiver side
- C** Center of light-band
- D<sub>A</sub>** Green indicator diode
- D<sub>B</sub>** Yellow indicator diode
- E** Preferred entry direction for precise positioning

**Electrical connection**

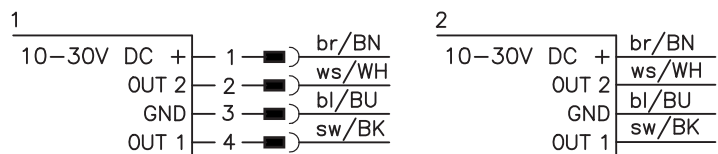

## Specifications

### Optical data

Typ. op. range limit (TK(S) 100x100) <sup>1)</sup>	0.4 ... 5.2m
Operating ranges <sup>2)</sup>	see tables
Light source <sup>3)</sup>	LED (modulated light)
Wavelength	620nm (visible red light)
Detection range	light-band approx. 50mm (see diagrams)
Resolution	typ. 12mm (max. approx. 8mm) <sup>4)</sup>

### Timing

Switching frequency	250 Hz
Response time	2ms
Delay before start-up	< 300ms

### Electrical data

Operating voltage $U_B$	10 ... 30VDC (incl. residual ripple)
Residual ripple	$\leq 15\%$ of $U_B$
Open-circuit current	$\leq 20$ mA
Switching outputs/functions	/4P 2 PNP switching outputs, antivalent
	/4X 1 PNP switching output, light switching
	/PX 1 PNP switching output, dark switching
	/2N 2 NPN switching outputs, antivalent
Signal voltage high/low	$\geq (U_B - 2V) / \leq 2V$
Output current	max. 100mA
Sensitivity	adjustment via teach button

### Indicators

Green LED	ready
Yellow LED	light path free
Flashing green/yellow LEDs	feedback during teach procedure

### Mechanical data

Housing	plastic (PC-PBT)
Connector	plastic (PBT)
Optics	plastic (PMMA)
Operation	teach button
Weight	with M12 connector: approx. 60g with 200mm cable and M12 connector: approx. 80g with 2000mm cable: approx. 100g
Connection type	M12 connector, 4-pin cable 200mm with M12 connector, 4-pin cable 2000mm, 4 x 0.20mm <sup>2</sup>

### Environmental data

Ambient temp. (operation/storage)	-40°C ... +60°C / -40°C ... +70°C
Protective circuit <sup>5)</sup>	2, 3
VDE safety class <sup>6)</sup>	III
Protection class	IP67, IP 69K
Light source	exempt group (in acc. with EN 62471)
Standards applied	IEC 60947-5-2
Chemical resistance	tested in accordance with ECOLAB

- 1) Typ. operating range limit: max. attainable range without performance reserve
- 2) Operating range: recommended range with performance reserve
- 3) Average life expectancy 100,000h at an ambient temperature of 25°C
- 4) Depends on teach-in, see diagrams (sensitivity **increased**  $\leq 12$  mm)
- 5) 2=polarity reversal protection, 3=short circuit protection for all transistor outputs
- 6) Rating voltage 50V

## Remarks

- Performance reserve decreases as sensitivity increases.
- Max. resolution: approx. 8mm.
- Further applications:
  - Detection of transparent media
  - Detection of depolarizing media, e.g. foil packaging
  - Use as muting sensor
- Multiple sensors can be operated in a small area

## Tables

### Plastic reflectors:

Reflectors	Operating range
1 TK(S) 100x100	0.4 ... 4.0m
2 TK(S) 40x60	0.4 ... 3.0m

1	0.4	4.0	5.2
2	0.4	3.0	3.9

Operating range [m]  
 Typ. operating range limit [m]

TK ... = adhesive  
 TKS ... = screw type

## Diagrams

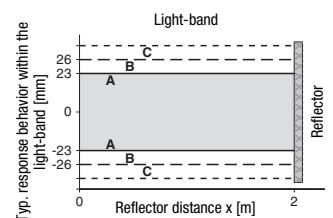

Reference object for detection: 19mm  
with reflector TKS 100x100

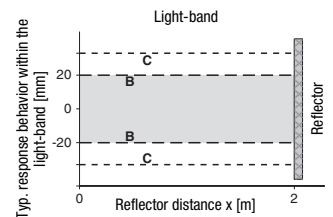

Reference object for detection: 12mm  
with reflector TKS 40x60

- A Standard** sensitivity
- B Increased** sensitivity
- C Further increased** sensitivity with **Easy tune** (range depends on taught value)

## Remarks

### Operate in accordance with intended use!

- ⚠ This product is not a safety sensor and is not intended as personnel protection.
- ⚠ The product may only be put into operation by competent persons.
- ⚠ Only use the product in accordance with the intended use.

**RK46C VarOS**

**Retro-reflective sensors**

**Part number code**

R K 4 6 C . D X L 3 / 4 P - M 1 2

<b>Operating principle</b>	
RK	Retro-reflective photoelectric sensor
<b>Series</b>	
46C	46C series
<b>Equipment</b>	
D	Depolarizing media
<b>Optical characteristic</b>	
XL	Large light spot
<b>Setting</b>	
3	Teach button
<b>Pin assignment of OUT1 (connector pin 4 / black cable wire)</b>	
2	NPN, light switching
N	NPN, dark switching
4	PNP, light switching
P	PNP, dark switching
<b>Pin assignment of OUT2 (connector pin 2 / white cable wire)</b>	
X	Not assigned
2	NPN, light switching
N	NPN, dark switching
4	PNP, light switching
P	PNP, dark switching
<b>Connection technology</b>	
M12	M12 connector, 4-pin
200-M12	Cable 200mm with M12 connector, 4-pin
free	Cable 2000mm

**Order guide**

The sensors listed here are preferred types; current information at [www.leuze.com](http://www.leuze.com).

		<b>Designation</b>	<b>Part no.</b>
<b>With M12 connector, 4-pin</b>	OUT1: PNP light switching, OUT2: PNP dark switching	RK46C.DXL3/4P-M12	50125752
	OUT1: PNP dark switching, OUT2: not connected	RK46C.DXL3/PX-M12	50125991
	OUT1: NPN light switching, OUT2: NPN dark switching	RK46C.DXL3/2N-M12	50126764
<b>With 200mm cable and M12 connector, 4-pin</b>	OUT1: PNP light switching, OUT2: PNP dark switching	RK46C.DXL3/4P-200-M12	50125755
<b>With cable, cable length 2m</b>	OUT1: PNP light switching, OUT2: PNP dark switching	RK46C.DXL3/4P	50125754

**Precise alignment of sensor**

The special shape and form of the light-band allows precise alignment of the sensor with the object to be detected or with the reflector.

**Advantages:**

- Maximum utilization of the light-band
- Reliable detection even with shocks/vibrations

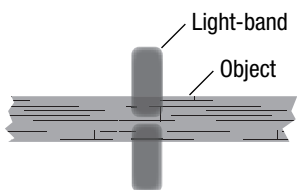

Align center of light-band with center of object/reflector!

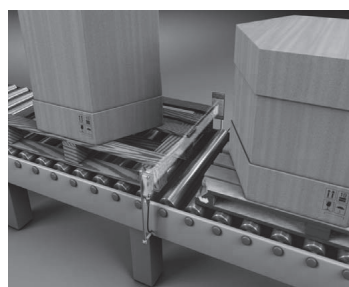

Reliable detection of different objects and objects with cutouts and openings, here pallets:

- different heights
- protruding boards
- damage

## Teach procedure for sensor



**Note**

It is essential to teach the sensor before it is used for the first time!  
The sensor is factory-set to the maximum operating range.

Before starting the teach procedure, align the light-band of the sensor with the center of the object and reflector!

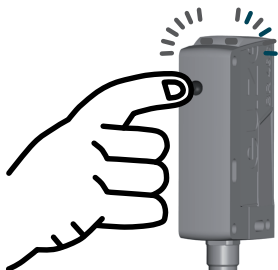
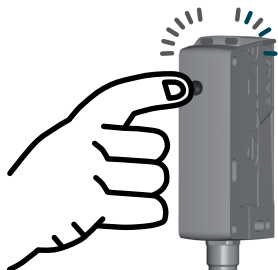
	Teach	
Sensor sensitivity	Standard	Increased
Switching behavior	Sensor switches when 28 % of light-band is covered by object.	Sensor switches when 18 % of light-band is covered by object.
Typical application	Reliable detection of pallets	Detection of containers with openings / transparent objects
Setting	<p><b>Clear light path to reflector!</b></p> <p><b>Press teach button</b> (2 to 7s) until both LEDs (green/yellow) <b>flash synchronously</b>.</p> <p>Release teach button – ready.</p> 	<p><b>Clear light path to reflector!</b></p> <p><b>Press teach button</b> (7 to 12s) until both LEDs (green/yellow) <b>flash alternately</b>.</p> <p>Release teach button – ready.</p> 
Acknowledgment	Teach successful: Both LEDs (green/yellow) remain lit.	
	Teach not successful: Yellow LED flashes; repeat teach procedure.	

## Easy tune – Fine adjustment of sensor sensitivity (switching threshold)

Easy tune allows you to adjust the sensor sensitivity in small steps using the teach button during normal operation.

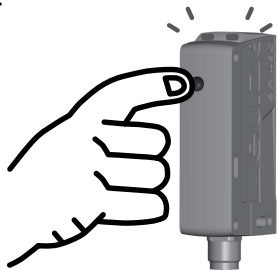
<b>Increase sensitivity (reduce switching threshold)</b>	<b>Briefly press teach button (2 to 200ms)</b> , sensitivity is increased slightly and switching threshold is reduced slightly.	<p>The sensor <b>confirms button actuation</b> by brief illumination (1x flash) of both LEDs.</p> 
<b>Reduce sensitivity (increase switching threshold)</b>	<b>Press and hold teach button (200 ms to 2s)</b> , sensitivity is reduced slightly and switching threshold is increased slightly.	

If the upper or lower end of the adjustment range is reached, both LEDs flash at a much higher frequency.

## Light/dark switching – Adjustment of switching behavior of switching outputs

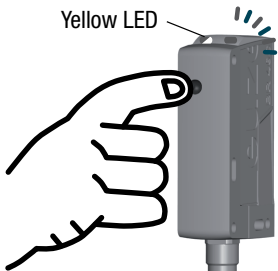
<b>Light/dark switching</b>	<p><b>Press teach button (&gt; 12s) until green LED flashes.</b></p> <p>The <b>yellow LED</b> indicates the <b>current setting of the switching outputs</b><sup>1)</sup>:</p> <p><b>ON =</b> Output OUT1 <b>light switching</b> Output OUT2 <b>dark switching</b></p> <p><b>OFF =</b> Output OUT1 <b>dark switching</b> Output OUT2 <b>light switching</b></p> <p>Release teach button – switchover is complete.</p> <p><sup>1)</sup>For factory settings, see part number code</p> 
-----------------------------	---