

Datasheet



- Easy-to-use Expert-style Static and Dynamic TEACH options, plus Window, Light, and Dark SET, via push button or remote input
- Smart power-control algorithm to maximize performance in low-contrast applications
- Easy push-button or remote sensor setup options:
 - Dark-Operate/Light-Operate select
 - Selectable 30 ms output OFF-delay
- Less than 1 millisecond output response for excellent sensing repeatability
- Tough ABS housing is rated IEC IP67; NEMA 6
- Bright LED operating status indicators are visible from 360°
- Discrete PNP or NPN output, depending on model
- Multiple connection options available (see Models)
- Compact housing, easy barrel-mount (some models) or side-mount installation



WARNING: Not To Be Used for Personnel Protection

Never use this device as a sensing device for personnel **protection**. Doing so could lead to serious injury or death. This device does not include the self-checking redundant circuitry necessary to allow its use in personnel safety applications. A sensor failure or malfunction can cause either an energized or de-energized sensor output condition.

Model	Sensing Mode	Range	Output	Model	Sensing Mode	Range	Output	
QS18EN6LP	660 nm Visible Red	3.5 m (12 ft)	NPN	QS18EN6CV15	CONVERGENT	16 mm (0.65 in)	NPN	
QS18EP6LP	POLAR RETRO		PNP	QS18EP6CV15			PNP	
QS18EN6D	940 nm Infrared	800 mm (31.5 in)	NPN	QS18EN6CV45	PLASTIC FIBER	43 mm (1.7 in)	NPN	
QS18EP6D			PNP	QS18EP6CV45			PNP	
QS18EN6DB		500 mm (19.7 in)	NPN	QS18EN6FP		660 nm Visible Red	Varies by mode and fiber optics used	NPN
QS18EP6DB			PNP	QS18EP6FP				PNP
QS18EN6W	DIFFUSE	300 mm (11.8 in)	NPN	QS18EN6DV	660 nm Visible Red	600 mm (23.6 in)	NPN	
QS18EP6W			PNP	QS18EP6DV			PNP	

The standard 2 m (6.5 ft) cable models are listed. To order the 9 m (30 ft) cable models, add the suffix "W/30" to the cabled model number. For example, QS18EN6FP W/30. Models with a quick disconnect (QD) connector require a mating cable.

To order a model with a 4-pin QD 150 mm (6 in) Euro-style pigtail, add suffix "Q5" (for example, QS18EN6FPQ5).

To order a model with a 4-pin 150 mm (6 in) Pico-style pigtail, add suffix "Q" (for example, QS18EN6FPQ).

To order a model with a 4-pin Integral Euro-style QD, add suffix "Q8" (for example, QS18EN6FPQ8).

To order a model with a 4-pin Integral Pico-style QD, add suffix "Q7" (for example, QS18EN6FPQ7).

¹ Specified using BRT-84 reflector (sold separately)



Overview of QS18E Expert Series Sensors

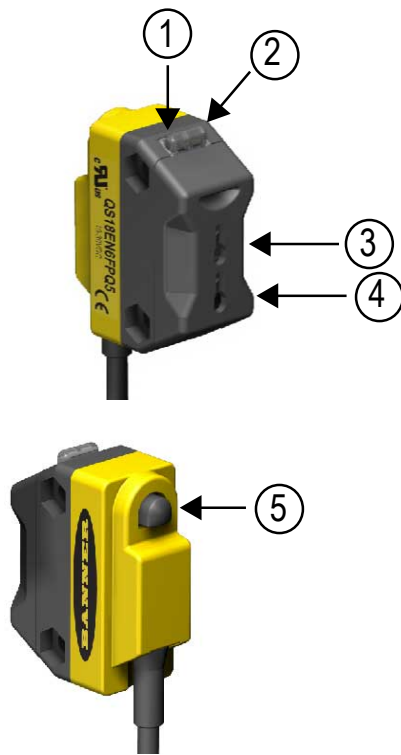

The QS18E Expert Sensors family of sensors provides high-performance sensing in a compact package. The sensors feature a discrete output (NPN or PNP, depending on model), two bright LEDs for easy status monitoring during configuration and operation, multiple configuration options, remote configuration, and security lockout options.

1. Amber output LED
2. Green power indicator LED
3. Receiver port
4. Emitter port
5. Configuration button

Indicators (Two LEDs: One Green, One Amber)		
Sensor Condition (Run Mode)	Green LED	Amber LED
Output OFF	ON	OFF
Output ON	ON	ON
Output ON, marginal signal	ON	Flashing
Output Short Circuit	Flashing	OFF

Figure 1. Sensor features

Wiring Diagrams

NPN (Sinking) Outputs

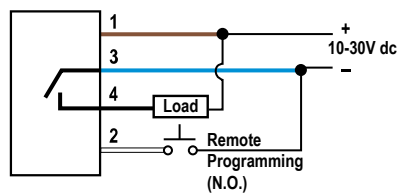

PNP (Sourcing) Outputs

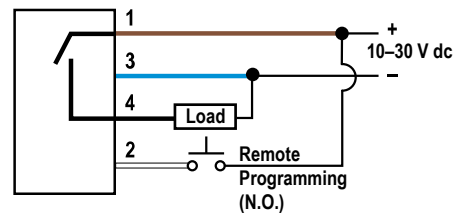

Cabled wiring diagrams are shown. Quick disconnect (QD) wiring diagrams are functionally identical.

Sensor Configuration

Configure the sensor using any of five TEACH or Set options (by push button or the remote wire) to define the sensing limits. Use a Setup procedure to enable a 30 ms OFF-delay or to change the Light-/Dark-Operate setting (see [Sensor Setup](#) on page 3). Sensing limit configuration options include:

- Static TEACH: one switching threshold, determined by two taught conditions
- Dynamic (on-the-fly) TEACH: one switching threshold, determined by multiple sampled conditions
- Light Set and Dark Set: one switching threshold, offset from a single sensing condition (the "dark" condition or the "light" condition; see Figure)
- Window Set: a sensing window, centered around a single sensing condition

The sensor's output is disabled during all TEACH and Set procedures, and is enabled upon return to Run mode.

Following any TEACH or Set procedure other than Static TEACH, the Output ON condition (Light- or Dark-Operate setting) remains as it was last configured. To change that setting or the OFF-delay setting, see [Sensor Setup](#) on page 3.

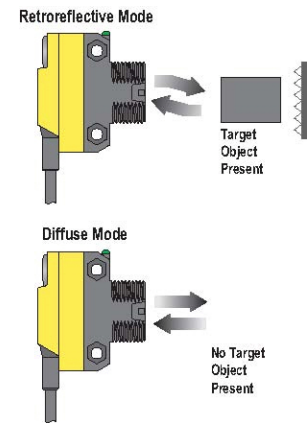

Figure 2. Dark Sensing Condition

Remote Configuration

Use the remote function to configure the sensor remotely or to disable the push button for security. Connect the white wire of the sensor to ground (0V dc), through a remote programming switch. Pulse the remote line according to the diagrams in the configuration procedures. The length of the individual programming pulses is equal to the value T: 0.04 seconds \leq T \leq 0.8 seconds

Push Button Enable/Disable

The remote input may be used to disable the sensor push button to prevent unauthorized adjustment. Connect the white wire of the sensor as described above to perform the procedure below to either enable or disable the feature.

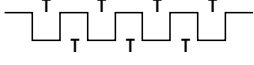
Push Button Enable/Disable		
Push Button (0.04 seconds \leq "Click" \leq 0.8 seconds)	Remote Line (0.04 seconds \leq T \leq 0.8 seconds)	Result
Not available	From Run mode, four-pulse the remote line. 	Sensor toggles between enable/disable settings and returns to RUN mode. Power LED: Flashes 3x, then ON Green Output LED: OFF, ² then ON or OFF, depending on output state

Returning to RUN Mode without Saving Settings

Exit Static TEACH and Set modes after the automatic 60-second time-out or by manually exiting the process. To manual exit, press and hold the push button (or hold the remote line low) for 2 seconds. The sensor returns to Run mode without saving any new settings.

Sensor Setup

Access setup functions directly from Run mode using the following procedures.

30 ms OFF-Delay (Pulse Stretcher) Enable/Disable

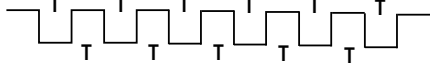
Push Button (0.04 seconds \leq "Click" \leq 0.8 seconds)	Remote Line (0.04 seconds \leq T \leq 0.8 seconds)	Results
From Run mode, six-click the push button. 	From Run mode, six-pulse remote line. 	Sensor toggles between enable/disable settings and returns to Run mode. Power LED: Flashes 3x, then ON Green Output LED: Enabled – ON, ³ Disabled – OFF, ³ Then ON or OFF, depending on output state

² Initial output LED condition is simultaneous with Power LED 3-flash
³ Initial Output LED condition is simultaneous with Power LED 3-flash.

Light-Operate/Dark-Operate Select

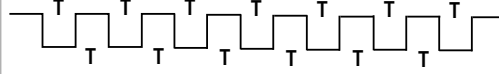
Push Button (0.04 seconds ≤ "Click" ≤ 0.8 seconds)	Remote Line (0.04 seconds ≤ T ≤ 0.8 seconds)	Results
From Run mode, seven-click the push button. 	From Run mode, seven-pulse remote line. 	Sensor toggles between Light-/Dark-Operate settings and returns to Run mode. Power LED: Flashes 3x, then ON Green Output LED: Light Operate – ON, ³ Dark Operate – OFF, ³ Then ON or OFF, depending on output state

Static TEACH

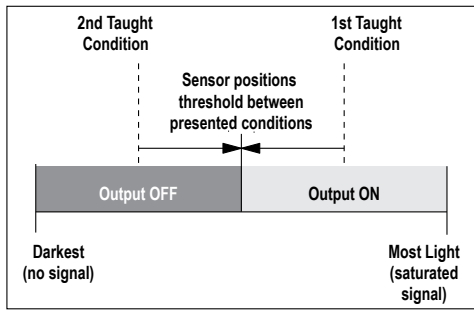





Figure 3. Static TEACH (Light Operate shown)

- Static TEACH locates a single switching threshold (switchpoint) at the optimal location between the two taught conditions, with the Output ON condition on one side, and the Output OFF condition on the other.
- During Static TEACH, the first condition taught is the ON condition. Output ON and OFF conditions may be reversed by switching the TEACH order or by changing the Light-/Dark-Operate setting in setup mode (see [Sensor Setup](#) on page 3).
- Static TEACH is recommended for applications where two conditions can be presented individually.



1. Access the Static TEACH Mode.

Method	Action	Result
Push Button	Press and hold the push button 2 to 4 seconds.	 The sensor waits for the first sensing condition. Power LED Indicator: OFF Output LED Indicator: Slow flash (1Hz)
Remote Line	No action required; the sensor is ready for the first sensing condition.	

2. Teach the first sensing condition.

Method	Action	Result
Push Button	Present the first (ON) sensing condition, then click the push button.	 Power LED Indicator: OFF Output LED Indicator: Double-flash
Remote Line	Present the first sensing condition, then single-pulse the remote line.	

3. Teach the second sensing condition.

Method	Action	Result
Push Button	Present the second (OFF) sensing condition, then click the push button.	 <u>TEACH Accepted</u> Power LED Indicator: Flashes 3 times, then solid green Output LED Indicator: OFF
Remote Line	Present the second sensing condition, then single-pulse the remote line.	 The sensor returns to Run mode with the new settings. <u>TEACH Not Accepted</u> Power LED Indicator: OFF Output LED Indicator: Slow flash (1 Hz) The sensor returns to the wait state, ready for the first sensing condition.

Dynamic TEACH

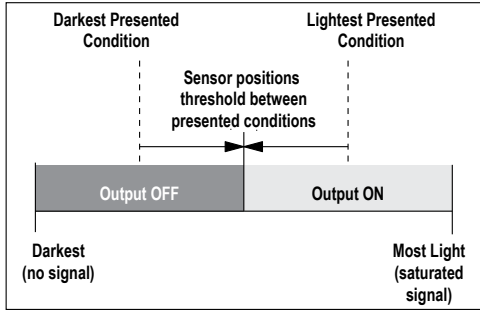



Figure 4. Dynamic TEACH (Light Operate shown)

- Dynamic TEACH sets a single switching threshold (switchpoint).
- Dynamic TEACH is used to teach during actual sensing conditions, taking multiple samples of the light and dark conditions and automatically setting the threshold at the optimum level.
- The Output ON state (Light- or Dark-Operate setting) remains as it was last configured. To change the Light-/Dark-Operate setting, see [Sensor Setup](#) on page 3.
- Dynamic TEACH is recommended for applications where a machine or process may not be stopped for teaching.

1. Access the Dynamic TEACH mode.

Method	Action	Result
Push Button	Press and hold the push button for longer than 4 seconds.	 Power LED Indicator: OFF Output LED Indicator: Quick flash (2 Hz)
Remote Line	Hold the remote line low (to ground) for longer than 2 seconds.	

2. Teach the sensing condition.

Method	Action	Result
Push Button	Continue to hold the push button and present the Output ON and OFF conditions multiple times.	 Power LED Indicator: OFF Output LED Indicator: Quick flash (2 Hz)
Remote Line	Continue to hold the remote line low (to ground) and present the Output ON and OFF conditions multiple times.	

3. Return to Run mode.

Method	Action	Result
Push Button	Release the push button.	 <u>TEACH Accepted</u> Power LED Indicator: Flashes 3 times, then solid green Output LED Indicator: OFF ⁴ , then ON or OFF depending on the output state The sensor returns to Run mode with the new settings.
Remote Line	Release the remote line/switch.	

⁴ The initial output LED indicator condition is simultaneous with the power LED indicator 3-flash

Light Set

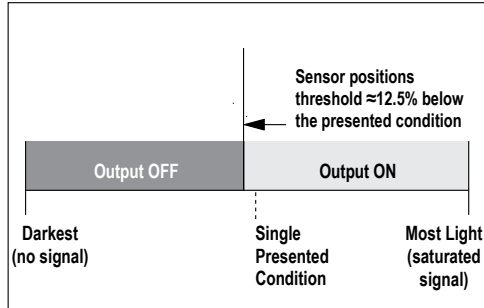

Figure 5. Light Set (Light Operate shown)

- Light Set sets a threshold approximately 12.5% below the presented sensing condition.
- Any condition darker than the threshold causes the output to change state.
- In Light-Operate mode, the presented condition is the Output ON condition. In Dark-Operate mode, the presented condition is the Output OFF condition. To change the Light-/Dark-Operate setting, see [Sensor Setup](#) on page 3.
- Light Set is recommended for applications where only one condition is known, for example a stable light background with varying darker targets, or in retroreflective applications.

1. Access the Light Set mode.

Method	Action		Result
Push Button	Press and hold the push button 2 to 4 seconds.		The sensor waits for the sensing condition. Power LED Indicator: OFF Output LED Indicator: Slow flash (1 Hz)
Remote Line	Single-pulse the remote line.		The sensor waits for the sensing condition. Power LED Indicator: OFF Output LED Indicator: Double-flash

2. Set the sensing condition.

Method	Action		Result
Push Button	Present the sensing condition, then four-click the push button.		<u>TEACH Accepted</u> Power LED Indicator: Flashes 3 times, then solid green Output LED Indicator: OFF ⁵ , then ON or OFF, depending on the output state
Remote Line	Present the sensing condition, then four-pulse the remote line.		The sensor returns to Run mode with the new settings. <u>TEACH Not Accepted</u> Power LED Indicator: OFF Output LED Indicator: Slow flash (1 Hz) The sensor returns to the wait state, ready for the sensing condition.

Dark Set

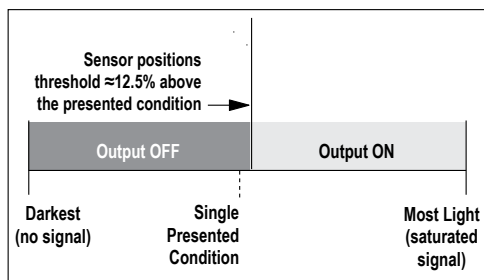



Figure 6. Dark Set (Light Operate shown)

- Dark Set sets a threshold approximately 12.5% above the presented sensing condition.
- Any condition lighter than the threshold causes the output to change state.
- In Light-Operate mode, the presented condition is the Output OFF condition. In Dark-Operate mode, the presented condition is the Output ON condition. To change the Light-/Dark-Operate setting, see [Sensor Setup](#) on page 3.
- Dark Set is recommended for applications where only one condition is known, for example a stable dark background with varying lighter targets, or when maximum excess gain is required.

1. Access the Dark Set mode.

Method	Action		Result
Push Button	Press and hold the push button 2 to 4 seconds.		The sensor waits for the sensing condition. Power LED Indicator: OFF Output LED Indicator: Slow flash (1 Hz)

⁵ The initial output LED indicator condition is simultaneous with the power LED indicator 3-flash.

Method	Action	Result
Remote Line	Single-pulse the remote line.	 <p>The sensor waits for the sensing condition. Power LED Indicator: OFF Output LED Indicator: Double-flash</p>

2. Set the sensing condition.

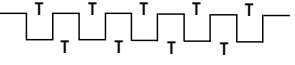
Method	Action	Result
Push Button	Present the sensing condition, then five-click the push button.	 <p><u>TEACH Accepted</u> Power LED Indicator: Flashes 3 times, then solid green Output LED Indicator: OFF⁶, then ON or OFF, depending on the output state The sensor returns to Run mode with the new settings.</p>
Remote Line	Present the sensing condition, then five-pulse the remote line.	 <p><u>TEACH Not Accepted</u> Power LED Indicator: OFF Output LED Indicator: Slow flash (1 Hz) The sensor returns to the wait state, ready for the sensing condition.</p>

Window Set

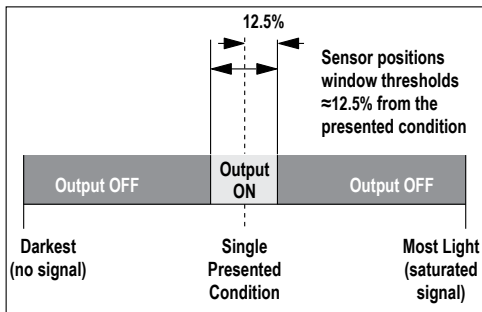





Figure 7. Window Set (Light Operate shown)

- In Window Set, the single ON condition window extends approximately 12.5% above and below the presented condition when Light Operate is selected. Output ON and OFF conditions may be reversed by changing the Light-/Dark-Operate setting (see [Sensor Setup](#) on page 3).
- Lighter or darker conditions outside of the window cause the output to change state.
- Window Set is recommended for applications where the target to be sensed may not always appear in the same place, or when other unwanted signals may appear.

1. Access the Window Set mode.

Method	Action	Result
Push Button	Press and hold the push button 2 to 4 seconds.	 <p>The sensor waits for the sensing condition. Power LED Indicator: OFF Output LED Indicator: Slow flash (1 Hz)</p>
Remote Line	Single-pulse the remote line.	 <p>The sensor waits for the sensing condition. Power LED Indicator: OFF Output LED Indicator: Double-flash</p>

2. Set the sensing condition.

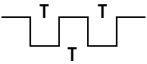
Method	Action	Result
Push Button	Present the sensing condition, then double-click the push button.	 <p><u>TEACH Accepted</u> Power LED Indicator: Flashes 3 times, then solid green Output LED Indicator: OFF⁷, then ON or OFF, depending on the output state The sensor returns to Run mode with the new settings.</p>
Remote Line	Present the sensing condition, then double-pulse the remote line.	 <p><u>TEACH Not Accepted</u> Power LED Indicator: OFF Output LED Indicator: Slow flash (1 Hz) The sensor returns to the wait state, ready for the sensing condition.</p>

⁶ The initial output LED indicator condition is simultaneous with the power LED indicator 3-flash.

⁷ The initial output LED indicator condition is simultaneous with the power LED indicator 3-flash.

Specifications

Supply Voltage
10 to 30 V dc (10% maximum ripple) at less than 35 mA, exclusive of load; 10 to 24 V dc at > 55° C

Supply Protection Circuitry
Protected against reverse polarity and transient voltages

Output Configuration
Current sourcing (PNP) or current sinking (NPN), depending on model; Light- or dark-operate selectable; Selectable 30 ms output OFF-delay
Rating: 100 mA max
Off-state leakage current: less than 50 µA at 30 V dc (see Application Note 1)
ON-state saturation voltage: less than 1.5 V at 100 mA (1.7V for 30 ft cable models)

Operating Conditions
Temperature: -20 °C to +70 °C (-4 °F to +158 °F)
Relative Humidity: 95% at +50 °C maximum relative humidity (non-condensing)

Application Notes
If the push button does not appear to be responsive, perform the push button enable procedure
To maintain backwards compatibility with earlier models, 3 remote line pulses or a push button hold followed by 3 push button clicks will perform a Dark SET.

Certifications



Output Protection Circuitry
Protected against false pulse on power-up and continuous overload or short-circuit of output

Output Response
Note: Momentary delay on power-up; output does not conduct during this time 600 µs ON/OFF

Repeatability
75 µs

Construction
ABS housing, PMMA lens

Connections
PVC-jacketed 4-conductor 2 m (6.5 ft) or 9 m (30 ft) unterminated cable, or 4-pin Euro-style or 4-pin Pico-style quick-disconnect (QD), either integral or 150 mm (6 in) pigtail, are available. QD cordsets are ordered separately.

Required Overcurrent Protection



WARNING: Electrical connections must be made by qualified personnel in accordance with local and national electrical codes and regulations.

Overcurrent protection is required to be provided by end product application per the supplied table.
Overcurrent protection may be provided with external fusing or via Current Limiting, Class 2 Power Supply.
Supply wiring leads < 24 AWG shall not be spliced.
For additional product support, go to www.bannerengineering.com.

Supply Wiring (AWG)	Required Overcurrent Protection (Amps)
20	5.0
22	3.0
24	2.0
26	1.0
28	0.8
30	0.5

Dimensions

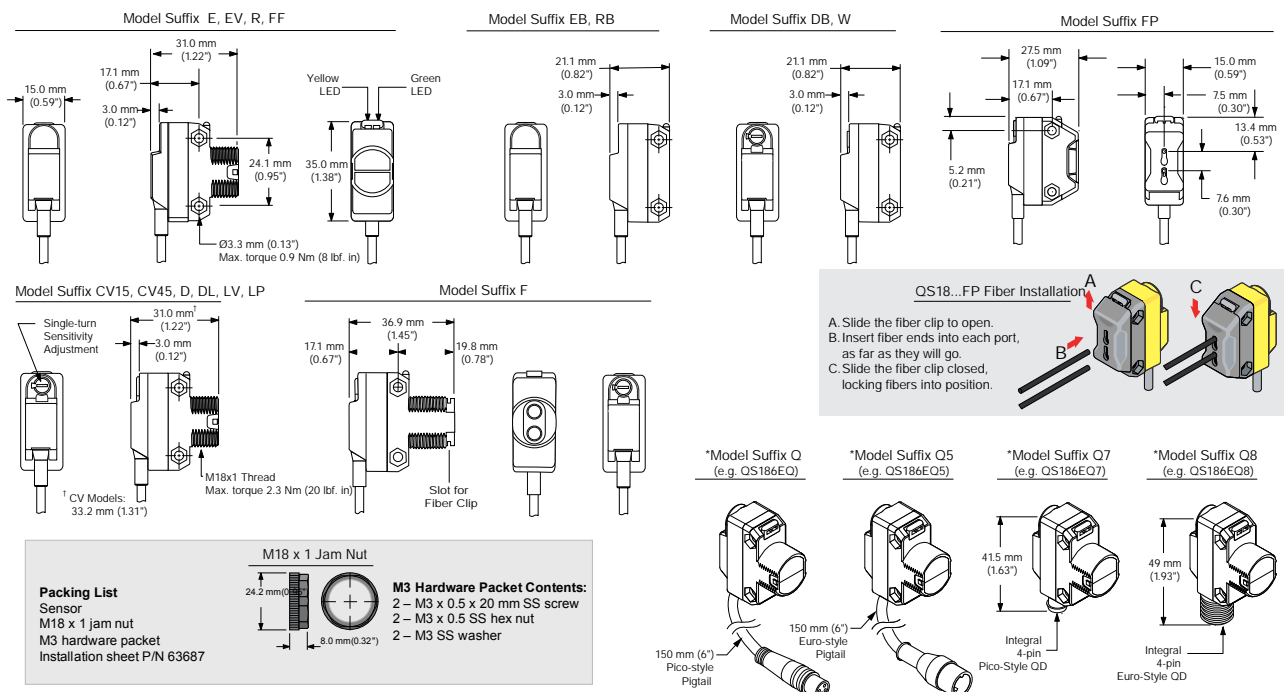

All measurements are listed in millimeters [inches], unless noted otherwise.

Performance Curves

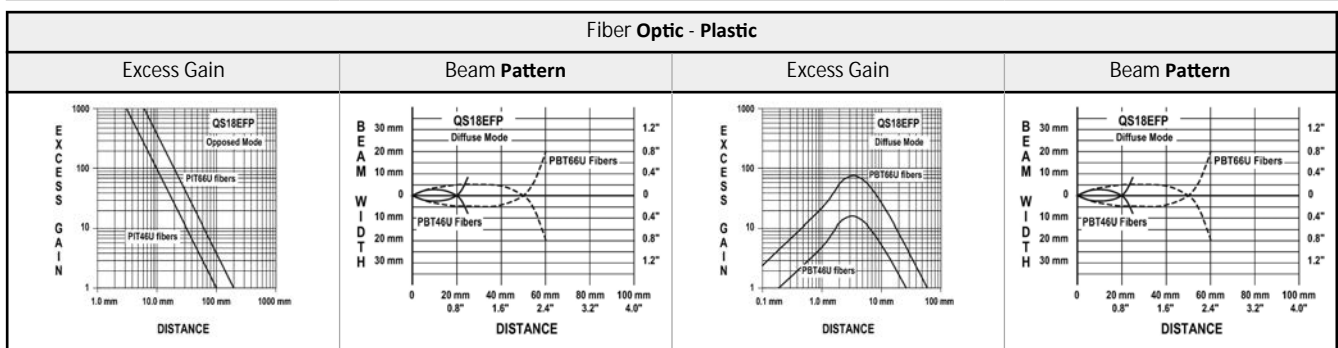
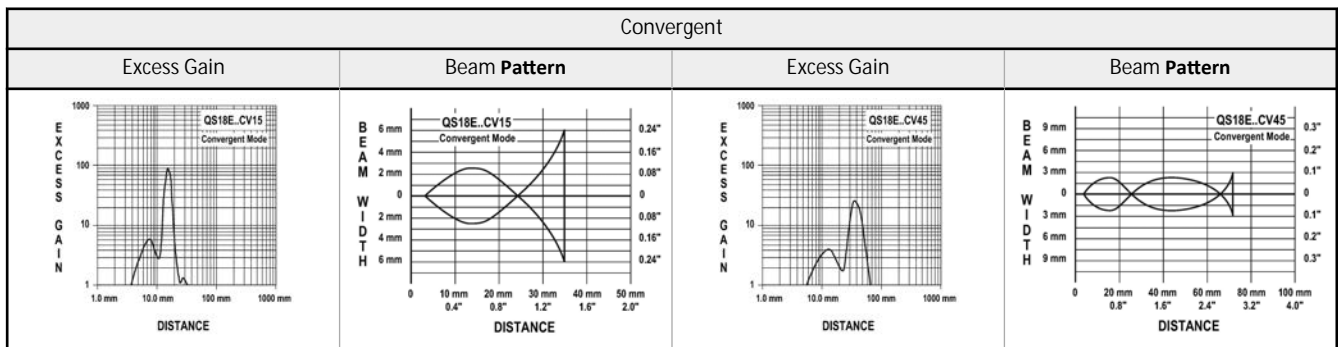
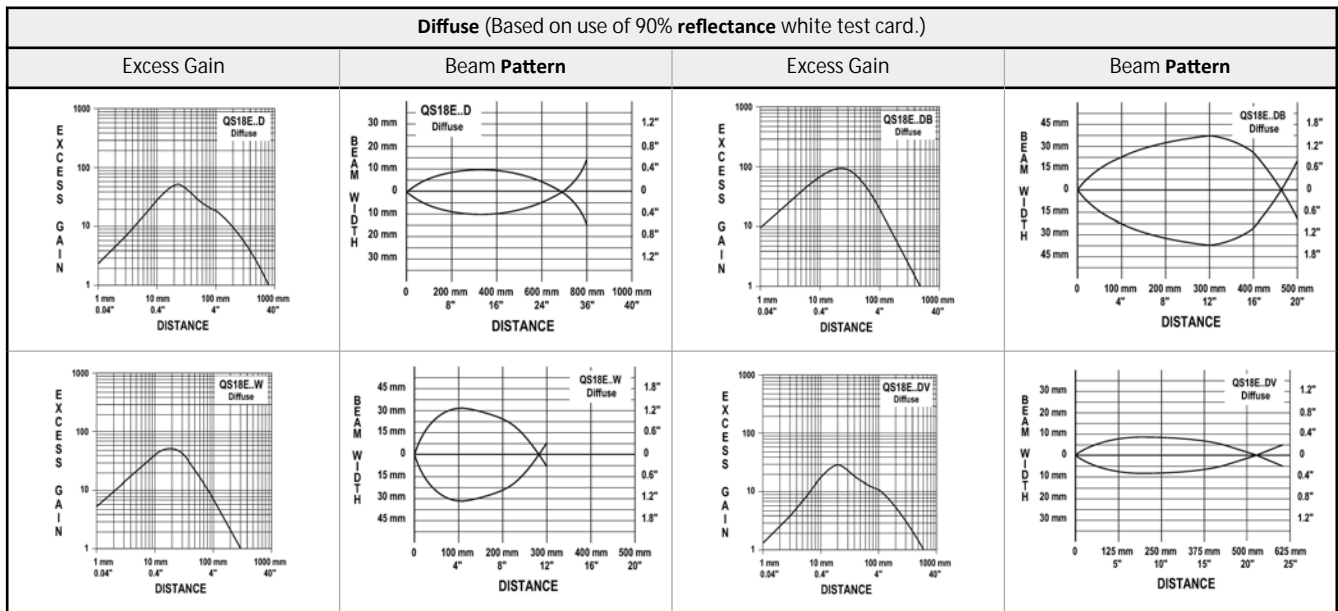
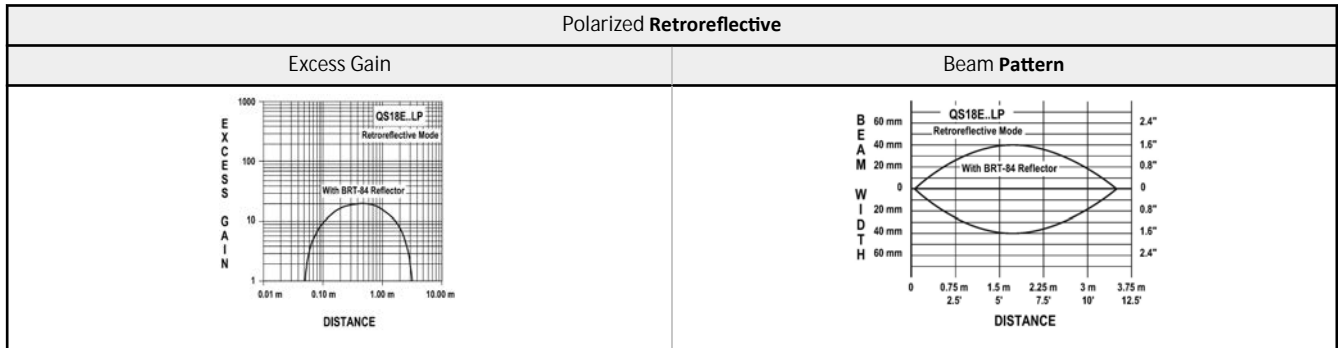

Performance using Dark Set, performed in no-light condition.

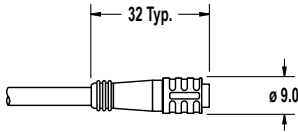
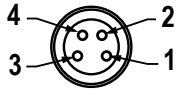
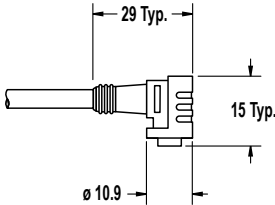

Accessories

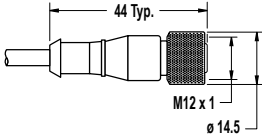
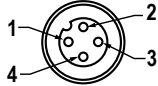
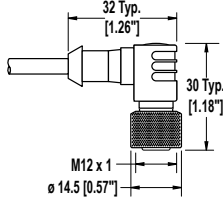
4-Pin Snap-on M8/Pico-Style Cordsets				
Model	Length	Style	Dimensions	Pinout (Female)
PKG4-2	2 m (6.56 ft)	Straight		 <p>1 = Brown 2 = White 3 = Blue 4 = Black</p>
PKW4Z-2	2 m (6.56 ft)	Right-Angle		

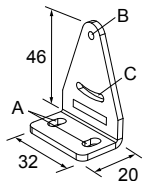
4-Pin Threaded M12/Euro-Style Cordsets				
Model	Length	Style	Dimensions	Pinout (Female)
MQDC-406	1.83 m (6 ft)	Straight		 <p>1 = Brown 2 = White 3 = Blue 4 = Black</p>
MQDC-415	4.57 m (15 ft)			
MQDC-430	9.14 m (30 ft)			
MQDC-450	15.2 m (50 ft)			
MQDC-406RA	1.83 m (6 ft)	Right-Angle		
MQDC-415RA	4.57 m (15 ft)			
MQDC-430RA	9.14 m (30 ft)			
MQDC-450RA	15.2 m (50 ft)			

<p>SMB312S</p> <ul style="list-style-type: none"> Stainless steel 2-axis, side-mount bracket  <p>A = 4.3 × 7.5, B = diam. 3, C = 3 × 15.3</p>	<p>SMBQS18DIN</p> <ul style="list-style-type: none"> Right-angle bracket assembly for mounting on 35 mm DIN rail 300 series stainless steel and glass filled nylon; zinc-plated screws 
---	--

SMBQS18Y

- Die-cast bracket for 18 mm holes
- Includes metal hex nut and lock washer
- Allows ± 8° for cabled sensors

Hole size: A = ø 15.3

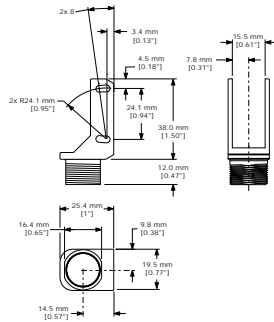

SMB18A

- Right-angle mounting bracket with a curved slot for versatile orientation
- 12-ga. stainless steel
- 18 mm sensor mounting hole
- Clearance for M4 (#8) hardware

Hole center spacing: A to B = 24.2

Hole size: A = ø 4.6, B = 17.0 × 4.6, C = ø 18.5

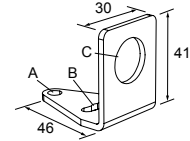

SMB4050YL

- Heavy-duty die-cast bracket for industrial protection
- Replaceable window for use with some sensor models
- M18 vertical mounting option
- Nut and lock washer included

A = ø 15.3

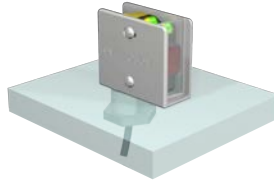

SMB3018SC

- 18 mm swivel side or barrel-mount bracket
- Black reinforced thermoplastic polyester
- Stainless steel swivel locking hardware included

Hole center spacing: A = 50.8

Hole size: A = ø 7.0, B = ø 18.0

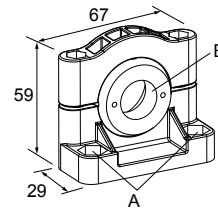

Additional available brackets: SMB46A, SMB18SF, SMBQS18RA, SMB18FA, SMBQS18A

For a list of reflectors or fiber optic assemblies, refer to the Accessories section of your current Banner Sensors catalog or visit www.bannerengineering.com for complete information.

Banner Engineering Corp. Limited Warranty

Banner Engineering Corp. warrants its products to be free from defects in material and workmanship for one year following the date of shipment. Banner Engineering Corp. will repair or replace, free of charge, any product of its manufacture which, at the time it is returned to the factory, is found to have been defective during the warranty period. This warranty does not cover damage or liability for misuse, abuse, or the improper application or installation of the Banner product.

THIS LIMITED WARRANTY IS EXCLUSIVE AND IN LIEU OF ALL OTHER WARRANTIES WHETHER EXPRESS OR IMPLIED (INCLUDING, WITHOUT LIMITATION, ANY WARRANTY OF MERCHANTABILITY OR FITNESS FOR A PARTICULAR PURPOSE), AND WHETHER ARISING UNDER COURSE OF PERFORMANCE, COURSE OF DEALING OR TRADE USAGE.

This Warranty is exclusive and limited to repair or, at the discretion of Banner Engineering Corp., replacement. IN NO EVENT SHALL BANNER ENGINEERING CORP. BE LIABLE TO BUYER OR ANY OTHER PERSON OR ENTITY FOR ANY EXTRA COSTS, EXPENSES, LOSSES, LOSS OF PROFITS, OR ANY INCIDENTAL, CONSEQUENTIAL OR SPECIAL DAMAGES RESULTING FROM ANY PRODUCT DEFECT OR FROM THE USE OR INABILITY TO USE THE PRODUCT, WHETHER ARISING IN CONTRACT OR WARRANTY, STATUTE, TORT, STRICT LIABILITY, NEGLIGENCE, OR OTHERWISE.

Banner Engineering Corp. reserves the right to change, modify or improve the design of the product without assuming any obligations or liabilities relating to any product previously manufactured by Banner Engineering Corp. Any misuse, abuse, or improper application or installation of this product or use of the product for personal protection applications when the product is identified as not intended for such purposes will void the product warranty. Any modifications to this product without prior express approval by Banner Engineering Corp will void the product warranties. All specifications published in this document are subject to change; Banner reserves the right to modify product specifications or update documentation at any time. Specifications and product information in English supersedes that which is provided in any other language. For the most recent version of any documentation, refer to: www.bannerengineering.com.