

Operating instructions
Electronic pressure sensor with diaphragm seal

UK

PY9001

PY9060

PY9070

80273698 / 00 01 / 2018

Contents



1	Preliminary note.....	3
1.1	Symbols used	3
2	Safety instructions	4
3	Functions and features	4
4	Function	5
4.1	Communication, parameter setting, evaluation	6
4.2	Switching function.....	6
4.3	Analogue function	7
4.4	IO-Link	8
5	Installation	9
5.1	Installation PY9060 and PY9001	10
5.2	Installation PY9070.....	11
6	Electrical connection.....	12
7	Operating and display elements	13
8	Menu.....	14
8.1	Menu structure: Main menu	14
8.2	Explanation of the menu.....	15
8.2.1	Explanation of menu level 1	15
8.2.2	Explanation of menu level 2	15
9	Parameter setting	16
9.1	Parameter setting in general	16
9.2	Configure display (optional).....	18
9.3	Set output signals	19
9.3.1	Set output functions.....	19
9.3.2	Set switching limits for the hysteresis function	19
9.3.3	Set switching limits for the window function	19
9.3.4	Scaling of the analogue value	20
9.4	User settings (optional).....	20
9.4.1	Set delay for the switching outputs	20
9.4.2	Set output logic for switching outputs	20
9.4.3	Set damping for the switching signal	20
9.4.4	Set damping for the analogue output	20

9.4.5	Zero-point calibration	20
9.4.6	Read min/max values for the system pressure	21
9.4.7	Reset all parameters to factory setting	21
9.4.8	Set colour change of the display	21
9.4.9	Graphical depiction of the colour change of the display	22
10	Operation	24
10.1	Read the set parameters	24
10.2	Self-diagnostics / fault indications	25
11	Technical data	27
11.1	Setting ranges	27
12	Factory setting	28

UK

1 Preliminary note

1.1 Symbols used

- ▶ Instructions
- > Reaction, result
- [...] Designation of keys, buttons or indications
- Cross-reference
-  Important note
Non-compliance may result in malfunction or interference
-  Information
Supplementary note

2 Safety instructions

- Read this document before setting up the product and keep it during the entire service life.
- The product must be suitable for the corresponding applications and environmental conditions without any restrictions.
- Only use the product for its intended purpose (→ Functions and features).
- Only use the product for permissible media (→ Technical data).
- If the operating instructions or the technical data are not adhered to, personal injury and/or damage to property may occur.
- The manufacturer assumes no liability or warranty for any consequences caused by tampering with the product or incorrect use by the operator.
- Installation, electrical connection, set-up, operation and maintenance of the product must be carried out by qualified personnel authorised by the machine operator.
- Protect units and cables against damage.

3 Functions and features

The diaphragm seal generates a special adaption for high-pressure applications in machines and plant to monitor the system pressure.

Application

Type of pressure: relative pressure

Order number	Measuring range		Pressure rating (max. permissible pressure) *)		Bursting pressure	
	bar	psi	bar	psi	bar	psi
Pressure sensors with G $\frac{1}{4}$ internal thread						
PY9970	0...400	0...5800	600	8700	800	1160
PY9060	0...600	0...8700	800	11580	1200	17400
PY9001	0...250	0...3625	500	7250	1000	14500
MPa = (measured value in bar) ÷ 10						
kPa = (measured value in bar) x 100						



The units are only suited to some extent for gas inclusion in the medium.
For critical media: Please contact the sales specialists.



Avoid static and dynamic overpressure exceeding the indicated pressure rating by taking appropriate measures.

The indicated bursting pressure must not be exceeded.

Even if the bursting pressure is exceeded only for a short time, the unit may be destroyed.

ATTENTION: risk of injury!



The units are vacuum resistant.

4 Function

- The pressure sensor with evaluation unit and measuring element is combined with a diaphragm seal. The diaphragm seal membrane transfers the system pressure to the measuring element via the fill fluid.
- Filling with pressure transfer fluid is carried out at the manufacturer and is designed to last the entire lifetime.
- The viscosity of the pressure transfer fluid is minimally influenced by the temperature so that the response time can slightly vary with the temperature conditions.
- The unit displays the current system pressure.
- It generates output signals according to the operating mode and the parameter setting.
- Moreover, it provides the process data via IO-Link.
- The unit is designed for fully bidirectional communication.
So, the following options are possible:
 - Remote display: reading and display of the current system pressure.
 - Remote parameter setting: reading and changing the current parameter setting.
 - IO parameter setting (→ 4.4)

4.1 Communication, parameter setting, evaluation

OUT1 (pin 4)	<ul style="list-style-type: none"> • Switching signal for system pressure limit • Communication via IO-Link
OUT2 (pin 2)	<ul style="list-style-type: none"> • Switching signal for system pressure limit • Analogue signal 4...20 mA / 0...10 V

4.2 Switching function

OUTx changes its switching status if it is above or below the set switching limits (SPx, rPx). The following switching functions can be selected:

- Hysteresis function / normally open: [ou1/ou2] = [Hno] (→ Fig. 1).
- Hysteresis function / normally closed: [ou1] / [ou2] = [Hnc] (→ Fig. 1).

First the set point (SPx) is set, then the reset point (rPx).

The hysteresis defined remains even if SPx is changed again.

- Window function / normally open: [ou1] / [ou2] = [Fno] (→ Fig. 2).
- Window function / normally closed: [ou1] / [ou2] = [Fnc] (→ Fig. 2).

The width of the window can be set by means of the difference between FHx and FLx. FHx = upper value, FLx = lower value.

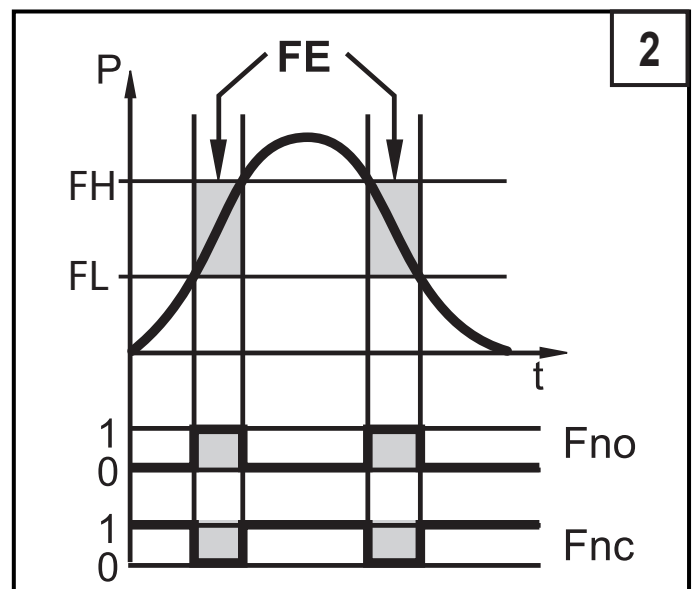
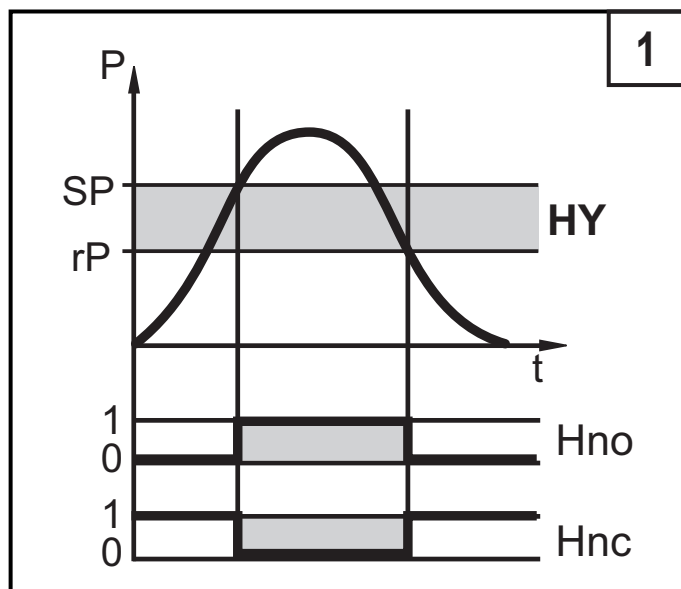

P = system pressure; HY = hysteresis; FE = window



When set to the window function the set and reset points have a fixed hysteresis of 0.25 % of the measuring span.

4.3 Analogue function

OUT2 is an analogue output:

- [ou2] defines whether the set measuring range is provided as 4...20 mA ([ou2] = [I]) or as 0...10 V ([ou2] = [U]).
- Analogue start point [ASP2] determines at which measured value the output signal is 4 mA or 0 V.
- Analogue end point [AEP2] determines at which measured value the output signal is 20 mA or 10 V.

UK

Minimum distance between [ASP2] and [AEP2] = 20 % of the measuring span.

Voltage output 0...10 V:

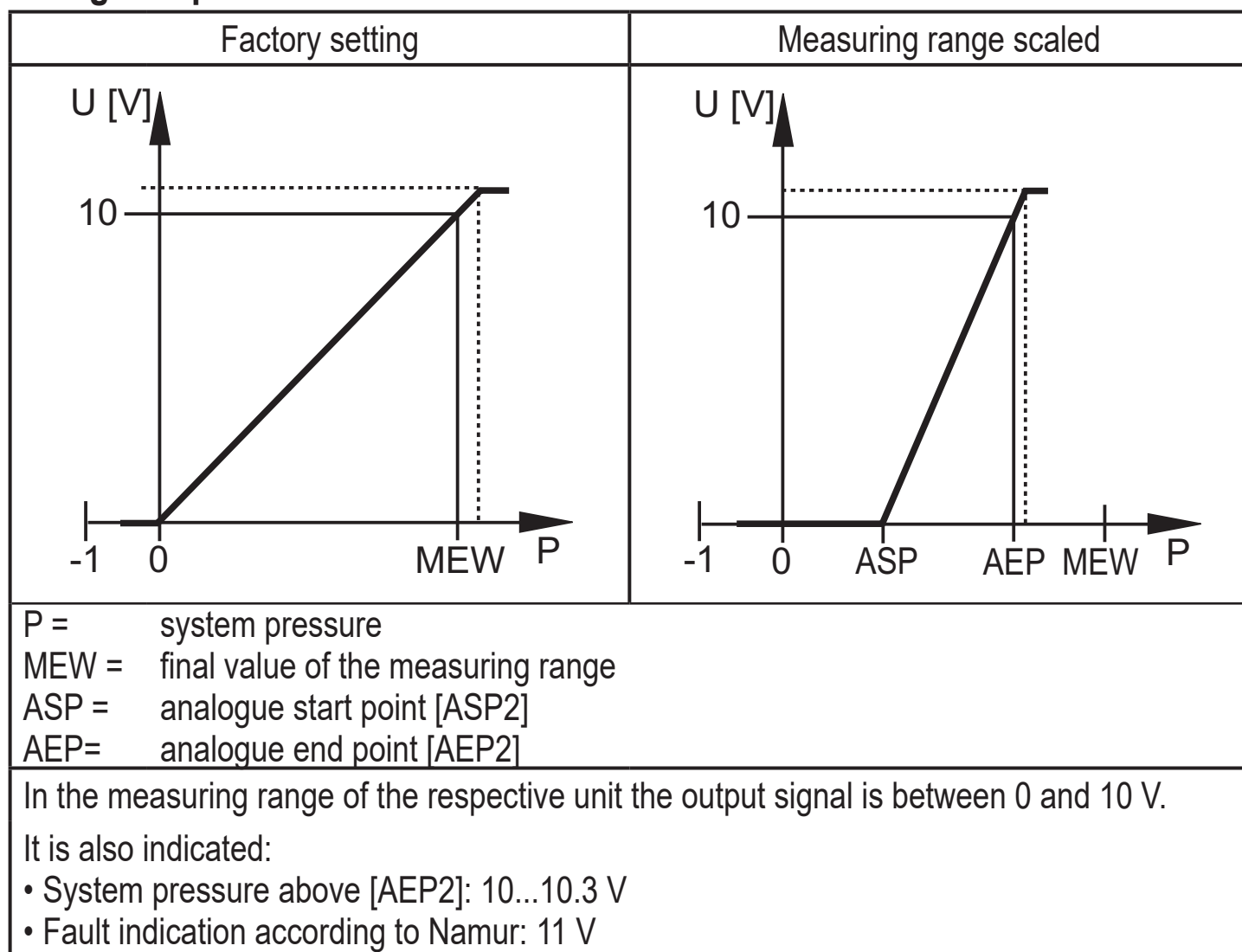

Current output 4...20 mA

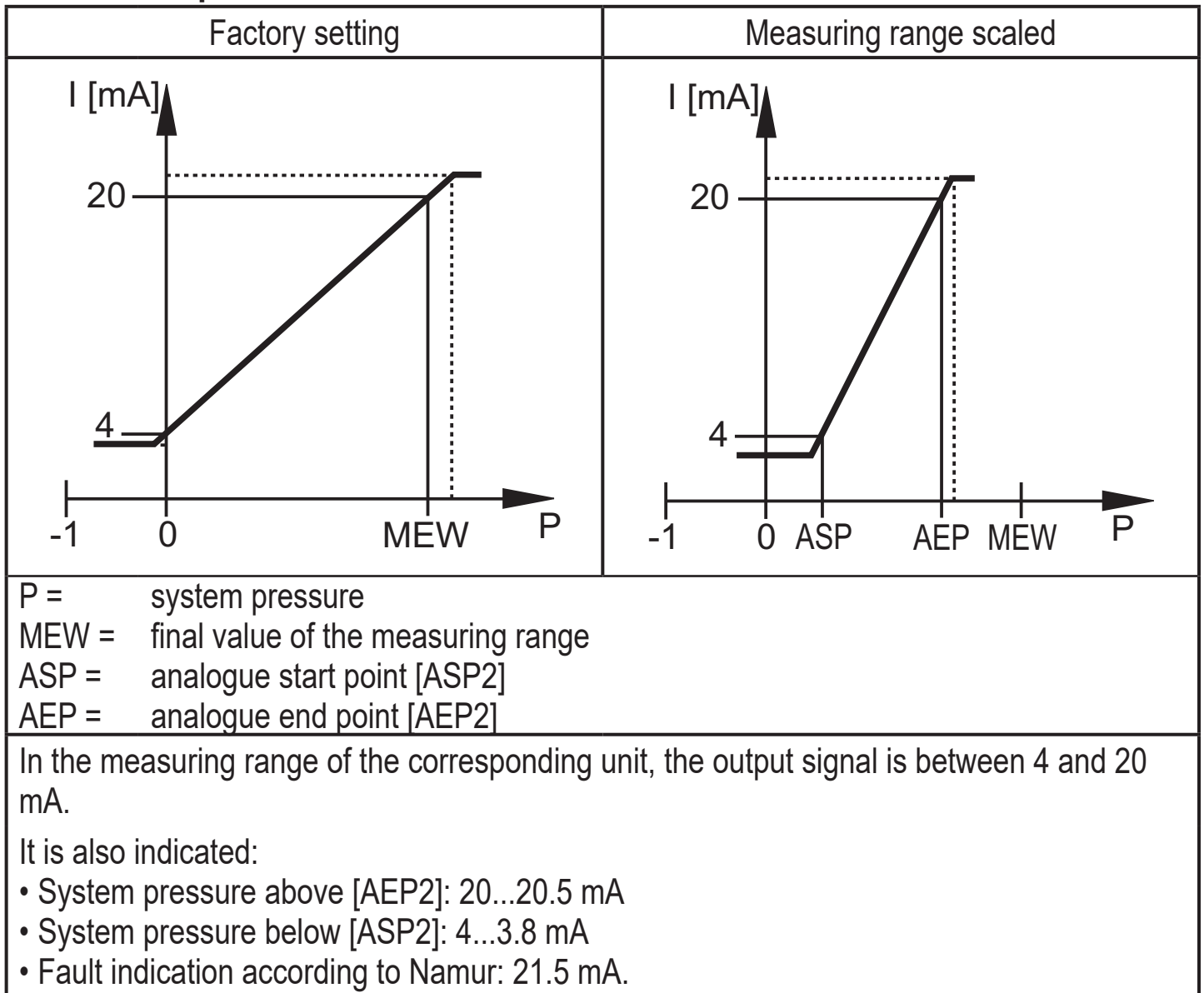

4.4 IO-Link

This unit has an IO-Link communication interface which requires an IO-Link capable module (IO-Link master) for operation.

The IO-Link interface enables direct access to the process and diagnostic data and provides the possibility to set the parameters of the unit during operation.

In addition, communication is possible via a point-to-point connection with a USB IO-Link master.

The IODDs necessary for the configuration of the unit, detailed information about process data structure, diagnostic information, parameter addresses and the necessary information about required IO-Link hardware and software can be found at www.ifm.com.

5 Installation



Before installing and removing the unit: Make sure that no pressure is applied to the system.



Mounting material is neither defined nor provided by ifm.



The membranes are very sensitive because of their small thickness of only a few μm and must not be damaged.

UK

- ▶ Check if the suitable unit is available for the application.
- ▶ Do not remove the original individual packaging of the diaphragm seal until it is installed.
- ▶ Do not damage sealed fill openings / screw connections.
- ▶ Avoid damage to the membrane and do not remove the protective cap before installation.
- ▶ To ensure ingress resistance and correct function only suitable seals, screws and nuts are to be used which are on the machine / plant or approved by applicable standards.

5.1 Installation PY9060 and PY9001

For installation, adhere to the instructions of the manufacturer of your plant. Use the mounting and sealing materials specified by the manufacturer of the plant.

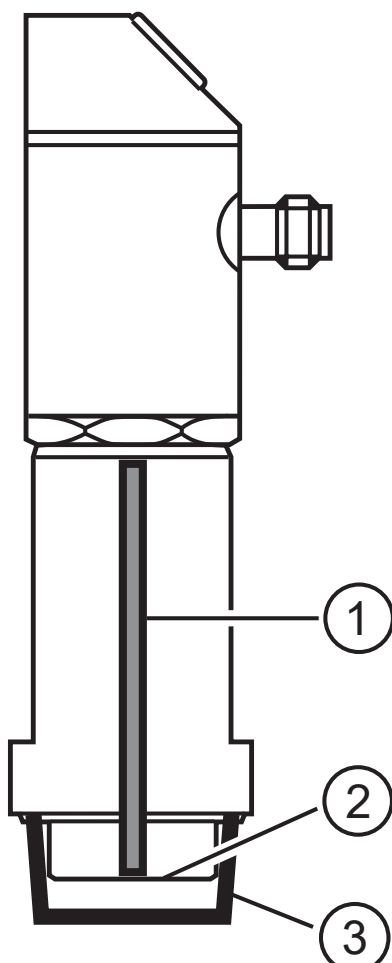

1 =	fill fluid
2 =	metal membrane
3 =	protective cap (to be removed before installation)

5.2 Installation PY9070

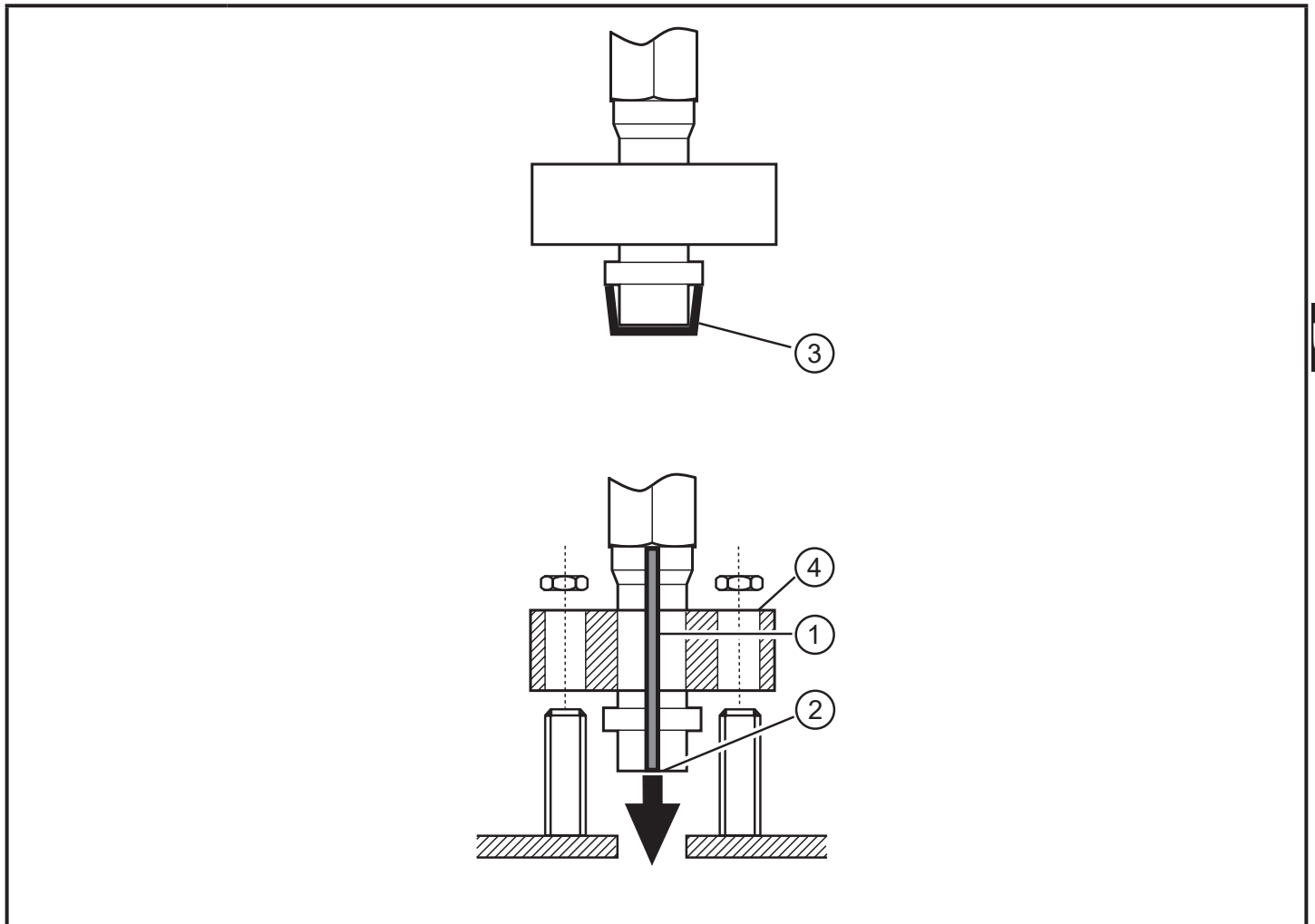

1 =	fill fluid
2 =	metal membrane
3 =	protective cap (to be removed before installation)
4 =	clamp flange

- ▶ Remove protective cap (3).
ATTENTION: Do not touch the metal membrane (2).
- ▶ Carefully insert the sensor tip into the location hole. The metal membrane (2) must not hit against the hole.
Use the seal indicated by the manufacturer of your plant.
- ▶ Slide the clamp flange (4) with the drill holes onto the threaded bolt of the homogeniser.
- ▶ Place the nuts on the bolt and tighten alternately (avoid tilting of the sensor tip).
Adhere to the instructions of the manufacturer of your plant.

6 Electrical connection



The unit must be connected by a qualified electrician.

The national and international regulations for the installation of electrical equipment must be adhered to.

Voltage supply according to EN 50178, SELV, PELV.

- ▶ Disconnect power.
- ▶ Connect the unit as follows:

Core colours			
BK	black		
BN	brown		
BU	blue		
WH	white		
			<p>OUT1: switching output or IO-Link</p> <p>OUT2: switching output or analogue output</p> <p>Colours to DIN EN 60947-5-2</p>
Wiring example			
2 x positive switching		2 x negative switching	
1 x positive switching / 1 x analogue		1 x negative switching / 1 x analogue	

7 Operating and display elements

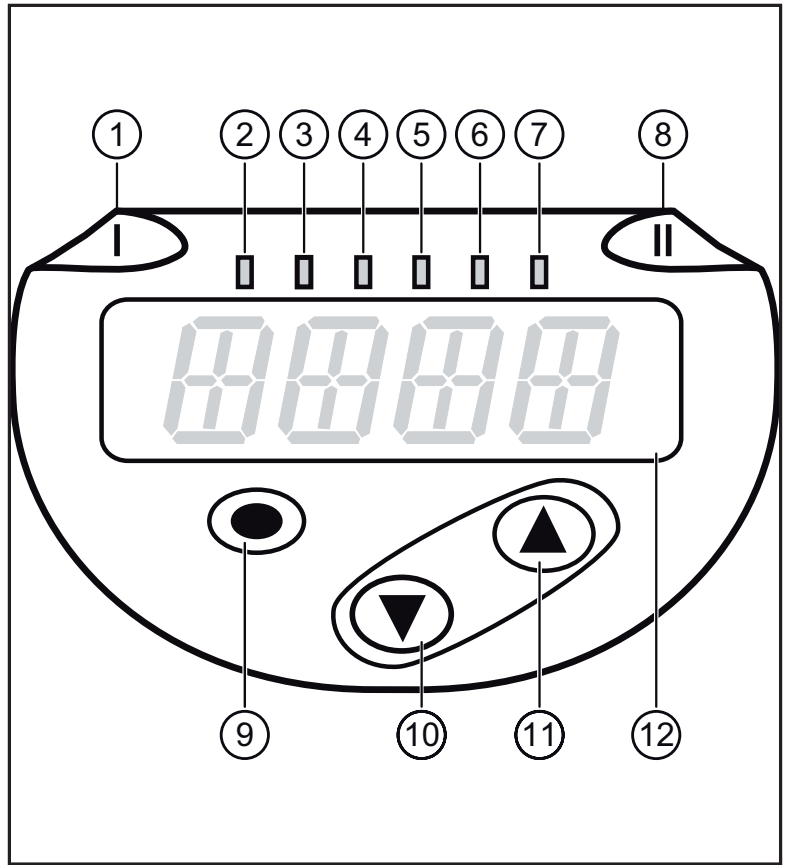

UK

1 to 8: Indicator LEDs	
LED 1	Switching status OUT1 (on when output 1 is switched).
LED 8	Switching status OUT2 (on when output 2 is switched).
LEDs 2 - 7	System pressure in the indicated unit of measurement (type of connection is unit-specific).
9: Enter button [•]	
- Selection of the parameters and acknowledgement of the parameter values.	
10 to 11: Arrow keys up [▲] and down [▼]	
- Setting of the parameter values (continuously by holding pressed; incrementally by pressing once).	
12: Alphanumeric display, 4 digits	
- Display of the current system pressure.	
- Display of the parameters and parameter values.	

8 Menu

8.1 Menu structure: Main menu

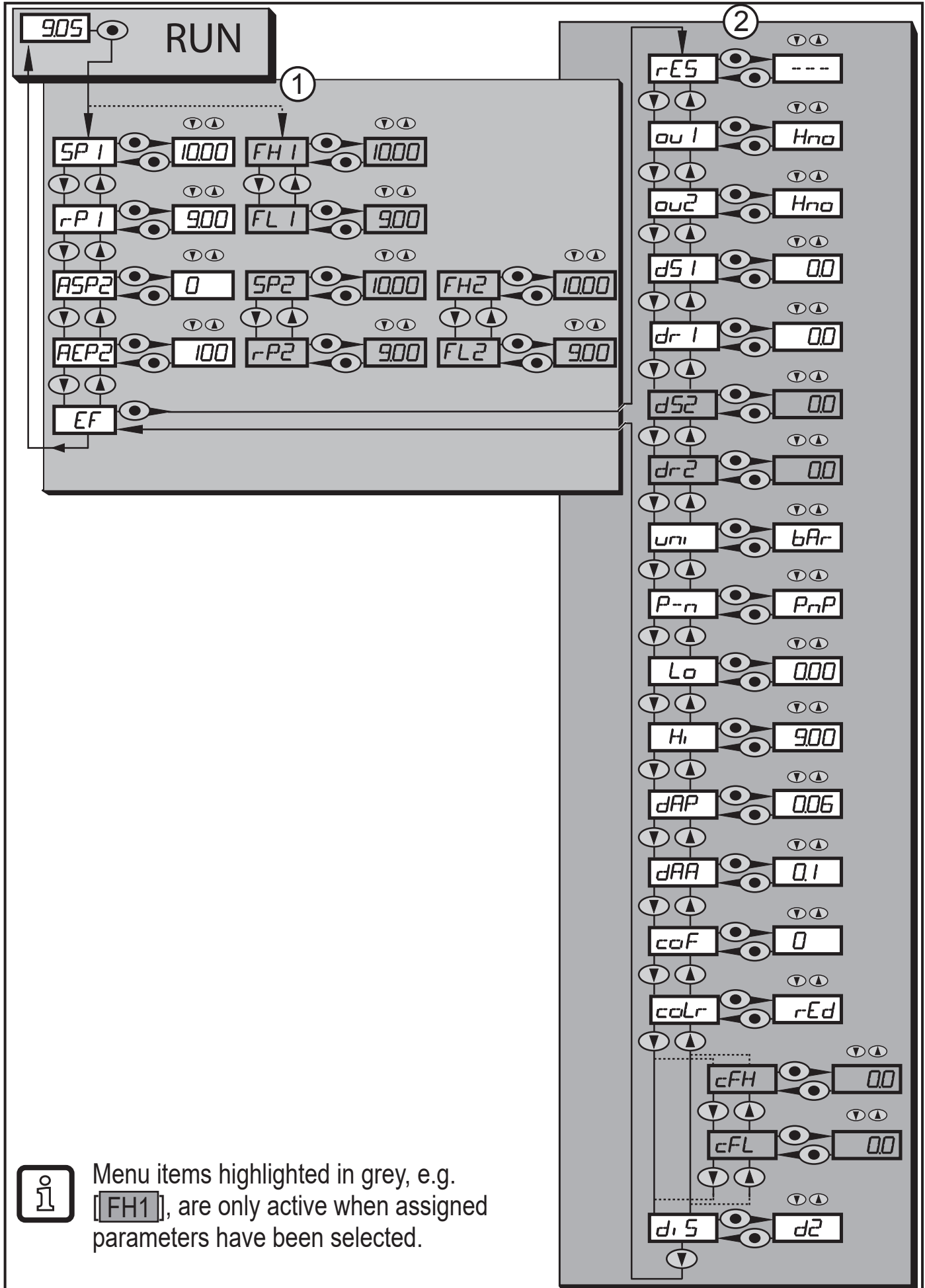

Menu items highlighted in grey, e.g. [FH1], are only active when assigned parameters have been selected.

8.2 Explanation of the menu

8.2.1 Explanation of menu level 1

SPx / rPx	Upper / lower limit value for system pressure at which OUTx switches with hysteresis setting. Requirement: OUTx setting is [Hno] or [Hnc].
FHx/FLx	Upper / lower limit for system pressure at which OUTx switches with window setting. Requirement: OUTx setting is [Fno] or [Fnc].
ASP2	Analogue start point for system pressure: measured value at which 4 mA / 0 V are provided. Requirement: OUT2 setting is [I] or [U].
AEP2	Analogue end point for system pressure: measured value at which 20 mA / 10 V are provided. Requirement: OUT2 setting is [I] or [U].
EF	Extended functions / opening of menu level 2.

UK

8.2.2 Explanation of menu level 2

rES	Restore factory setting.
ou1	Output function for OUT1: <ul style="list-style-type: none"> • Switching signal for the pressure limits: hysteresis function [H ..] or window function [F ..], either normally open [. no] or normally closed [. nc].
ou2	Output function for OUT2: <ul style="list-style-type: none"> • Switching signal for the pressure limits: hysteresis function [H ..] or window function [F ..], either normally open [. no] or normally closed [. nc]. • Analogue signal for the current system pressure: 4...20 mA [I] or 0...10 V [U].
dS1 / dS2	Switching delay for OUT1 / OUT2.
dr1 / dr2	Switch-off delay for OUT1 / OUT2.
uni	Standard unit of measurement for system pressure (display): [bAr] / [mbar] / [MPa] / [kPa] / [PSI] / [inHG] / [iH2O] / [mmWS].
P-n	Output logic: PNP / NPN.
Lo	Minimum value memory for system pressure.
Hi	Maximum value memory for system pressure.
dAP	Damping of the switch point.
dAA	Damping of the analogue output. Requirement: OUT2 setting is [I] or [U].
coF	Zero-point calibration.
coLr	Assignment of the display colours "red" and "green" within the measuring range.
cFH / cFL	Upper / lower value for colour change. Parameter only active after selection of a freely definable colour window in the coLr parameter: [r-cF] or [G-cF].
diS	Update rate and orientation of the display.

9 Parameter setting

During parameter setting the unit remains in the operating mode. It continues to monitor with the existing parameters until the parameter setting has been completed.

9.1 Parameter setting in general

3 steps must be taken for each parameter setting:

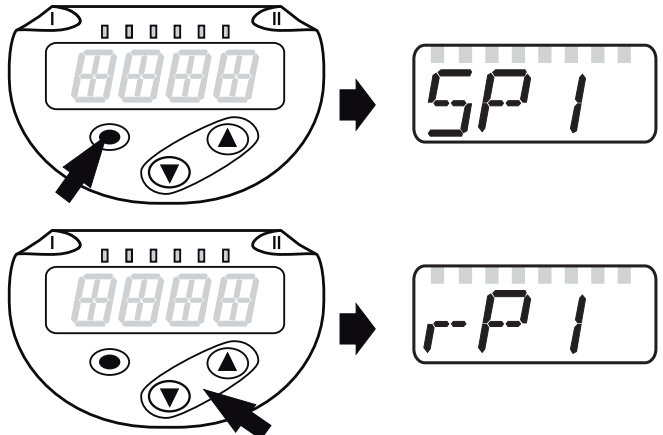
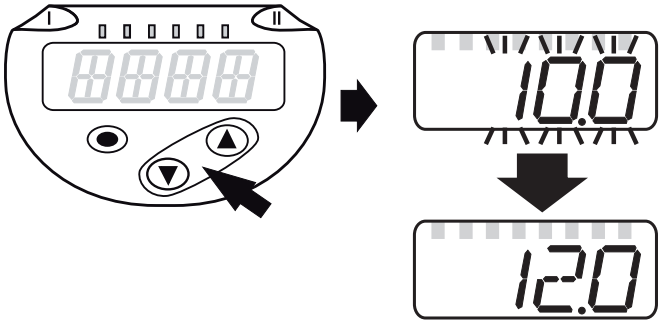
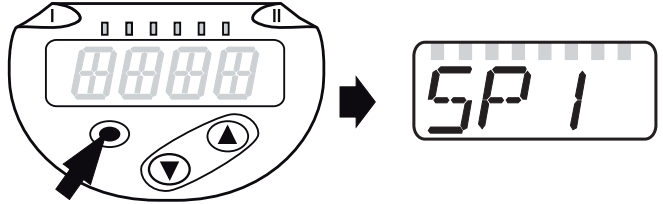
1	Select parameter <ul style="list-style-type: none">▶ Press [●] to get to the menu.▶ Press [▲] or [▼] until the required parameter is displayed.	
2	Set parameter value <ul style="list-style-type: none">▶ Press [●] to edit the selected parameter.▶ Press [▲] or [▼] for at least 1 s.> After 1 s: setting value is changed: incrementally by pressing the button once or continuously by keeping the button pressed.	
Numerical values are incremented continuously with [▲] or decremented with [▼].		
3	Acknowledge parameter value <ul style="list-style-type: none">▶ Briefly press [●].> The parameter is displayed again. The new setting value is saved.	
Set other parameters <ul style="list-style-type: none">▶ Press [▲] or [▼] until the required parameter is displayed.		
Finish parameter setting <ul style="list-style-type: none">▶ Press [▲] or [▼] several times until the current measured value is displayed or wait for 30 s.> The unit returns to the process value display.		



If [C.Loc] is displayed when an attempt is made to modify a parameter value, a parameter setting process is active via the IO-Link communication (temporary locking).



If [S.Loc] is displayed, the sensor is permanently locked via software. This locking can only be removed with a parameter setting software.

- Change from menu level 1 to menu level 2:

<ul style="list-style-type: none"> ▶ Press [●] to get to the menu. ▶ [▼] Press [▼] until [EF] is displayed. 	<p>The diagram shows two steps. In the first, a hand presses the center button of the device, and the display changes from '8888' to 'SP 1'. In the second, a hand presses the down arrow button, and the display changes to 'EF'.</p>
<ul style="list-style-type: none"> ▶ Press [●]. > The first parameter of the submenu is displayed (here: [rES]). 	<p>The diagram shows a hand pressing the center button of the device, and the display changes from '8888' to 'rES'.</p>

- Lock / unlock

The unit can be locked electronically to prevent unintentional settings.

<ul style="list-style-type: none"> ▶ Make sure that the unit is in the normal operating mode. ▶ Press [▲] + [▼] simultaneously for 10 s. > [Loc] is displayed. 	<p>The diagram shows a hand pressing both the up and down arrow buttons simultaneously for 10 seconds, as indicated by a bracket and '10 s'. The display then changes from '8888' to 'Loc'.</p>
<p>During operation: [Loc] is briefly displayed if you try to change parameter values.</p>	

For unlocking:

- ▶ Make sure that the unit is in the normal operating mode.
- ▶ Press [▲] + [▼] simultaneously for 10 s.
- > [uLoc] is displayed.

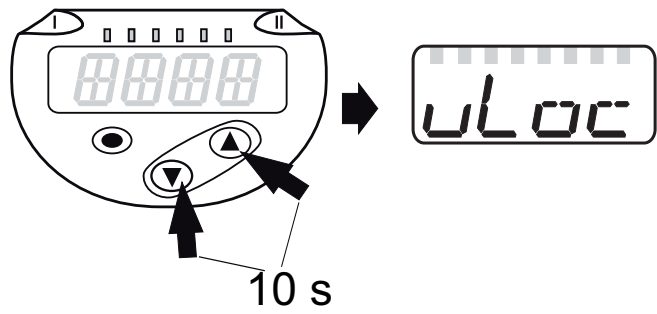

On delivery: not locked.

• Timeout:

If no button is pressed for 30 s during parameter setting, the unit returns to the operating mode with unchanged values.

• Exit parameter without applying the settings

To exit a parameter without applying the settings:

- ▶ Press [▲] + [▼] simultaneously.
- > Return to the menu level.

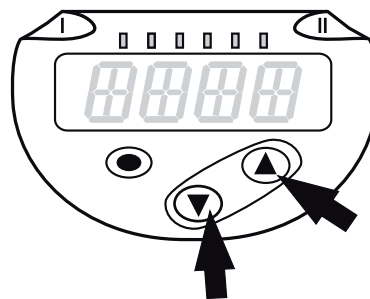

• Exit menu level

To exit the menu level:

- ▶ Press [▲] + [▼] simultaneously.
- > Menu level 2 changes to level 1 or level 1 changes to display.

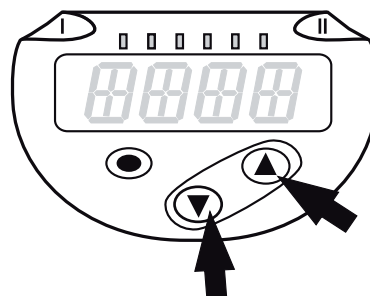



9.2 Configure display (optional)

- ▶ Select [Uni] and set the unit of measurement:
 - [bAr], [mbAr],
 - [MPa], [kPa],
 - [PSI],
 - [inHG],
 - [iH2O],
 - [mmWS]

U71





The selectable units of measurement depend on the respective unit.



<p>▶ Select [diS] and set the update rate and orientation of the display:</p> <ul style="list-style-type: none"> - [d1]: update of the measured values every 50 ms. - [d2]: update of the measured values every 200 ms. - [d3]: update of the measured values every 600 ms. - [rd1], [rd2], [rd3]: display as with d1, d2, d3; rotated by 180°. - [OFF] = The display is switched off in the operating mode. When one of the buttons is pressed, the current measured value is displayed for 30 s. The LEDs remain active even if the display is deactivated. 	
	<p>Even with unsteady pressure characteristics [d1] provides optimum readability; the corresponding algorithms are stored.</p>

9.3 Set output signals

9.3.1 Set output functions

<p>▶ Select [ou1] and set the switching function:</p> <ul style="list-style-type: none"> - [Hno] = hysteresis function/NO, - [Hnc] = hysteresis function/NC, - [Fno] = window function/NO, - [Fnc] = window function/NC. 	
<p>▶ Select [ou2] and set the analogue function:</p> <ul style="list-style-type: none"> - [Hno] = hysteresis function/NO, - [Hnc] = hysteresis function/NC, - [Fno] = window function/NO, - [Fnc] = window function/NC. - [I] = current signal 4...20 mA, - [U] = voltage signal 0...10 V. 	

9.3.2 Set switching limits for the hysteresis function

<p>▶ [ou1] / [ou2] must be set as [Hno] or [Hnc].</p> <p>▶ Select [SPx] and set the value at which the output is set.</p>	
<p>▶ Select [rPx] and set the value at which the output is reset.</p> <p>rPx is always lower than SPx. The unit only accepts values which are lower than the value for SPx.</p>	

9.3.3 Set switching limits for the window function

<p>▶ [ou1] / [ou2] must be set as [Fno] or [Fnc].</p> <p>▶ Select [FHx] and set the upper limit.</p>	
--	---

<p>▶ [Select [FLx] and set the lower limit. FLx is always lower than FHx. The unit only accepts values which are lower than the value for FHx.</p>	<p>FL1 FL2</p>
--	--------------------

9.3.4 Scaling of the analogue value

<p>▶ Select [ASP2] and set the value at which 4 mA / 0 V is provided.</p>	<p>ASP2</p>
<p>▶ Select [AEP2] and set the value at which 20 mA / 10 V is provided. Minimum distance between ASP2 and AEP2 = 20 % of the measuring span (scaling factor 5).</p>	<p>AEP2</p>

9.4 User settings (optional)

9.4.1 Set delay for the switching outputs

<p>[dS1] / [dS2] = switching delay for OUT1 / OUT2. [dr1] / [dr2] = reset delay for OUT1 / OUT2. ▶ Select [dS1], [dS2], [dr1] or [dr2] and set a value between 0 and 50 s (at 0 the delay time is not active).</p>	<p>dS1 dr1 dS2 dr2</p>
<p> For this unit the parameters [dSx] und [drx] for the set and reset points are designed strictly to the VDMA guideline.</p>	

9.4.2 Set output logic for switching outputs

<p>▶ Select [P-n] and set [PnP] or [nPn].</p>	<p>P--n</p>
---	-------------

9.4.3 Set damping for the switching signal

<p>▶ Select [dAP] and set the damping constant in seconds (τ value: 63 %); setting range 0.000...4.000 s.</p>	<p>dAP</p>
<p> Damping [dAP] affects the switch point / process data flow (IO-Link communication) and the display.</p>	

9.4.4 Set damping for the analogue output

<p>▶ Select [dAA] and set the damping constant (rise time 10...90 %) in seconds; setting range 0.000...4.000 s.</p>	<p>dAA</p>
<p> Damping [dAA] only influences the analogue output / analogue signal path.</p>	

9.4.5 Zero-point calibration

<p>▶ Select [coF] and set a value between -5 % and 5 % of the final value of the measuring range (if PN2x69 and PN2x99 ± 5 % of the measuring span). The internal measured value "0" is shifted by this value.</p>	<p>coF</p>
---	------------

9.4.6 Read min/max values for the system pressure

<ul style="list-style-type: none"> ▶ Select [Hi] or [Lo] and briefly press [●]. [Hi] = maximum value, [Lo] = minimum value. <p>Delete memory:</p> <ul style="list-style-type: none"> ▶ Select [Hi] or [Lo]. ▶ Press [▲] or [▼] and keep pressed until [----] is displayed. ▶ Briefly press [●]. 	<p>Hi</p> <p>Lo</p>
---	---------------------

9.4.7 Reset all parameters to factory setting



<ul style="list-style-type: none"> ▶ Select [rES]. ▶ Press [●] ▶ Press [▲] or [▼] and keep pressed until [----] is displayed. ▶ Briefly press [●]. <p>It is recommended to note down your own settings before carrying out a reset (→ 12 Factory setting).</p>	<p>rES</p>
--	------------

UK

9.4.8 Set colour change of the display

<ul style="list-style-type: none"> ▶ Select [coLr] and set the function: <ul style="list-style-type: none"> - [rEd] = Display colour red (independent of the measured value). - [GrEn] = Display colour green (independent of the measured value). - [r1ou] = Display colour red when OUT1 switches. - [G1ou] = Display colour green when OUT1 switches. - [r2ou] = Display colour red when OUT2 switches ([ou2] = [Hxx] / [Fxx]). - [G2ou] = Display colour green when OUT2 switches ([ou2] = [Hxx] / [Fxx]). - [r-12] = Display colour red when the measured value is between the limits of OUT1 and OUT2 ([ou2] = [Hxx] / [Fxx]). - [G-12] = Display colour green when the measured value is between the limits of OUT1 and OUT2 ([ou2] = [Hxx] / [Fxx]). - [r-cF] = Display colour red when the measured value is between the freely definable limits [cFH]^{*)} and [cFL]^{*)}. - [G-cF] = Display colour green when the measured value is between the freely definable limits [cFH]^{*)} and [cFL]^{*)}. <p>^{*)} The parameters [cFH] and [cFL] can only be selected in the menu tree when [r-cF] or [G-cF] has been activated.</p>	<p>coLr</p>
<ul style="list-style-type: none"> ▶ Select [cFH] and set the upper limit (only possible if [r-cF] or [G-cF] has been activated). > The setting range corresponds to the measuring range and its minimum limit is [cFL]. 	<p>cFH</p>
<ul style="list-style-type: none"> ▶ Select [cFL] and set the lower limit (only possible if [r-cF] or [G-cF] has been activated). > The setting range corresponds to the measuring range and its maximum limit is [cFH]. 	<p>cFL</p>

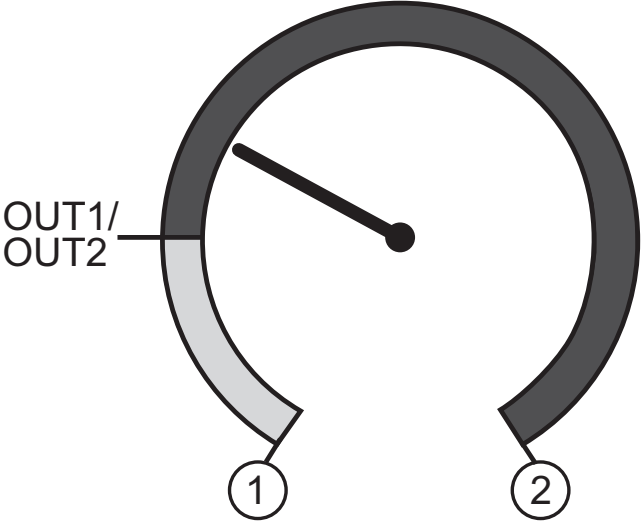
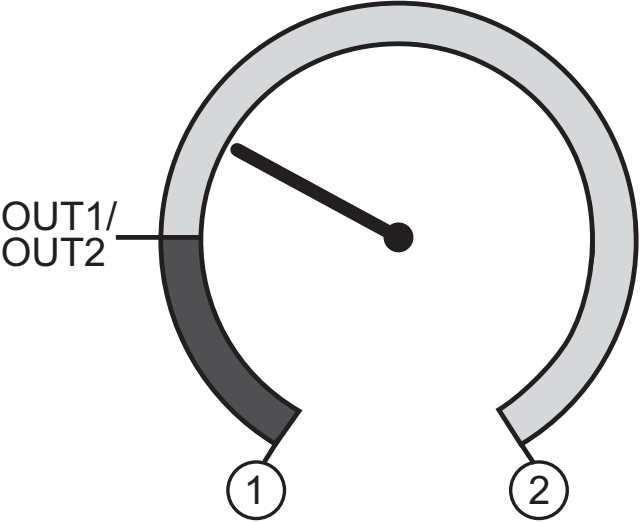
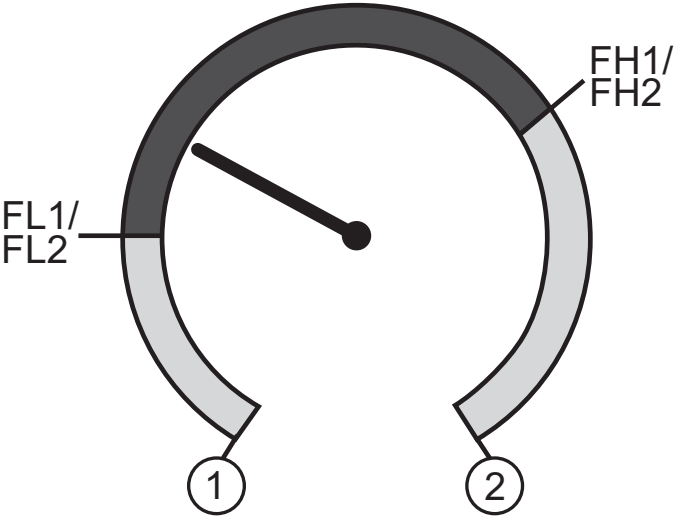
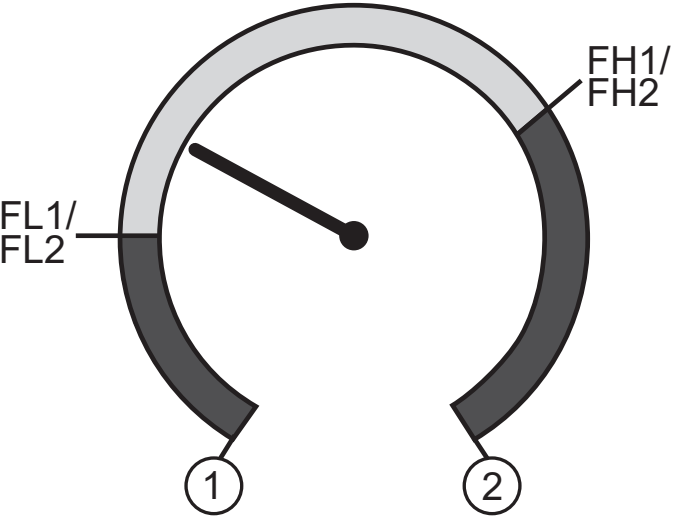
9.4.9 Graphical depiction of the colour change of the display

<p>Display colour change for the parameters [r1ou] / [r2ou], mode hysteresis function</p>	<p>Display colour change for the parameters [G1ou] / [G2ou], mode hysteresis function</p>
	
<p>Measured value > switch point OUT1/OUT2; display = red</p>	<p>Measured value > switch point OUT1/OUT2; display = green</p>
<p>Display colour change for the parameters [r1ou] / [r2ou], mode window function</p>	<p>Display colour change for the parameters [G1ou] / [G2ou], mode window function</p>
	
<p>Measured value between FL1/FL2 and FH1/FH2; display = red</p>	<p>Measured value between FL1/FL2 and FH1/FH2; display = green</p>
	<p>Colour change display green</p>
	<p>Colour change display red</p>
<p>1</p>	<p>Initial value of the measuring range</p>
<p>2</p>	<p>Final value of the measuring range</p>



Visualisation [r-12] / [G-12] only possible if [ou2] = switching output.

UK

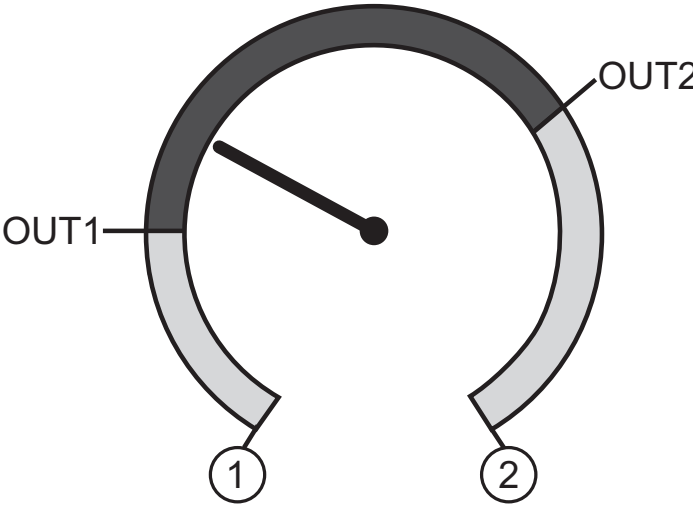
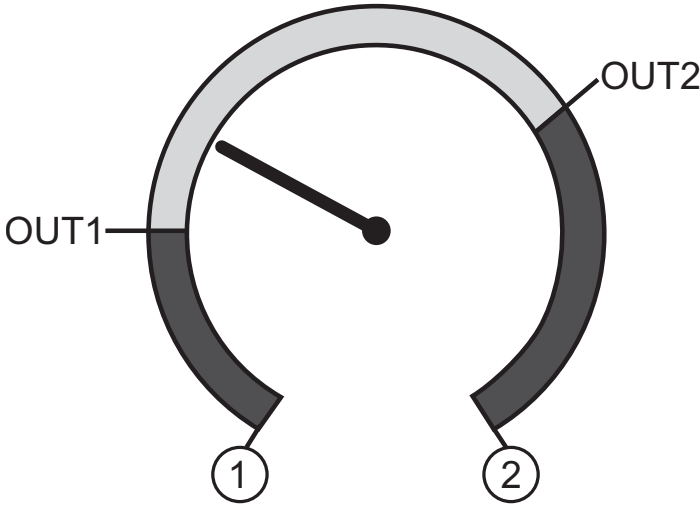
<p>Display colour change for the parameter [r-12], mode hysteresis function</p>	<p>Display colour change for the parameter [G-12], mode hysteresis function</p>
	
<p>Measured value between OUT1 and OUT2; display = red</p>	<p>Measured value between OUT1 and OUT2; display = green</p>

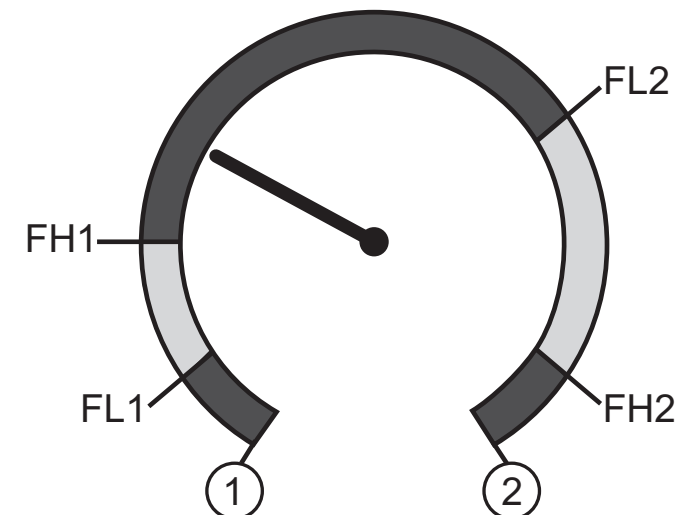
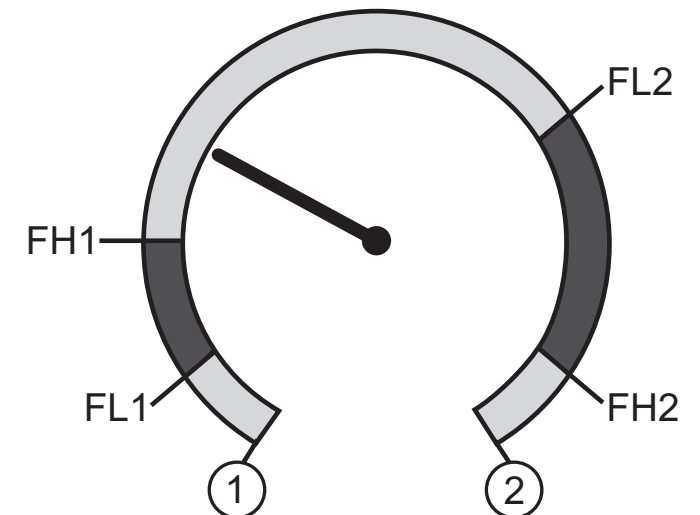
<p>Display colour change for the parameter [r-12], mode window function</p>	<p>Display colour change for the parameter [G-12], mode window function</p>
	
<p>Measured value outside FL1...FH1 and FL2...FH2; display = red</p>	<p>Measured value outside FL1...FH1 and FL2...FH2; display = green</p>

	<p>Colour change display green</p>
	<p>Colour change display red</p>
<p>1</p>	<p>Initial value of the measuring range</p>
<p>2</p>	<p>Final value of the measuring range</p>
<p>FL1 / FL2</p>	<p>Lower limit value window function outputs OUT1 / OUT2</p>
<p>FH1 / FH2</p>	<p>Upper limit value window function outputs OUT1 / OUT2</p>

Display colour change with parameter [r-cF] independent of OUT1.	Display colour change with parameter [G-cF] independent of OUT1.
Measured value between cFL and cFH; display = red	Measured value between cFL and cFH; display = green

	Colour change display green
	Colour change display red
1	Initial value of the measuring range
2	Final value of the measuring range
cFL	Lower limit (independent of the output function)
cFH	Upper limit (independent of the output function)

10 Operation

After power on, the unit is in the Run mode (= normal operating mode). It carries out its measurement and evaluation functions and provides output signals according to the set parameters.

Operation indication (→ 7 Operating and display elements).

10.1 Read the set parameters

- ▶ Press [●].
- ▶ Press [▲] or [▼] until the requested parameter is displayed.
- ▶ Briefly press [●].
- > The unit displays the corresponding parameter value for approx. 30 s; then it changes to the process value display.

10.2 Self-diagnostics / fault indications

The unit has many self-diagnostic options.

- It monitors itself automatically during operation.
- Warnings and faults are displayed (even if the display is deactivated), in addition they are available via the parameter setting software.

Display	Status LED OUT1	Status LED OUT2	Type of fault *)	Fault / warning	Corrective measures
none			F	Supply voltage too low.	▶ Check / correct the supply voltage.
SC flashes	flashes	flashes	F	Excessive current on switching outputs OUT1 and OUT2 **).	▶ Check switching outputs for short-circuit or excessive current; remove the fault.
SC1 flashes	flashes		F	Excessive current at switching output OUT1 **).	▶ Check switching output OUT1 for short-circuit or excessive current; remove the fault.
SC2 flashes		flashes	F	Excessive current at switching output OUT2 **).	▶ Check switching output OUT2 for short-circuit or excessive current; remove the fault.
Loc			W	Parameter setting locked via pushbuttons.	▶ Unlock buttons → 9.1 Parameter setting in general → "Lock / unlock".
C.Loc			W	Parameter setting locked via pushbuttons, parameter setting is active via IO-Link communication (→ 9.1).	▶ Wait until parameter setting via IO-Link is finished.
S.Loc			W	Setting buttons locked via parameter software. Parameter change is rejected (→ 9.1).	▶ Unlocking only possible via IO-Link interface / parameter setting software.

Display	Status LED OUT1	Status LED OUT2	Type of fault *)	Fault / warning	Corrective measures
OL			W	Process value too high (measuring range exceeded).	▶ Check / reduce system pressure / select unit with corresponding measuring range.
UL			W	Process value too low (value below measuring range).	▶ Check / increase system pressure / select unit with corresponding measuring range.
Err flashes			F	Internal fault / malfunction.	▶ Contact the manufacturer.

*) F = fault

W = warning

**) The output remains deactivated as long as the excessive current / short circuit continues.

11 Technical data

11.1 Setting ranges

		SP		rP		ASP2		AEP2		cFH		cFL		ΔP
		min	max	min	max	min	max	min	max	min	max	min	max	
PY9060	bar	4	600	1	597	0	480	120	600	3	600	0	597	1
	psi	60	8700	20	8660	0	6960	1740	8700	40	8700	0	8660	20
	MPa	0.4	60	0.1	59.7	0.0	48	12	60	0.3	60	0.0	59.7	0.1
PY9070	bar	2.5	400	1	398.5	0	320	80	400	1.5	400	0	398.5	0.5
	psi	40	5800	10	5780	0	4640	1160	5800	20	5800	0	5780	10
	MPa	0.25	40	0.1	39.85	0	32	8	40	0.15	40	0.0	39.85	0.05
PY9001	bar	1.5	250	0.5	249	0	200	50	250	1	250	0	249	0.5
	psi	25	3625	10	3610	0	2900	725	3625	15	3625	0	3610	5
	MPa	0.15	25	0.05	24.9	0	20	5	25	0.1	25	0.0	24.9	0.05

UK

ΔP = step increment



Further technical data and scale drawing at: www.ifm.com

12 Factory setting

	Factory setting	User setting
SP1	25 % of VMR***	
rP1	23 % of VMR***	
ou1	Hno	
ou2	I	
SP2	75 % VMR***	
rP2	73 % of VMR***	
ASP2	0	
AEP2	100 % OF VMR*	
coF	0	
dSx	0.0	
drx	0.0	
P-n	PnP	
dAP	0.06	
dAA	0.1	
diS	d2	
uni	bAr	
coLr	rEd	
cFH	VMR*	
cFL	MAW**	

* = Final value of the measuring range (VMR)

** = Initial value of the measuring range (MAW)

*** = The indicated percentage of the final value of the measuring range (VMR) of the respective sensor is set in bar.

More information at www.ifm.com