

**PRKL 3B**

**Laser retro-reflective photoelectric sensor with polarization filter**

en 11-2016/01 50105363-02



**Dimensioned drawing**

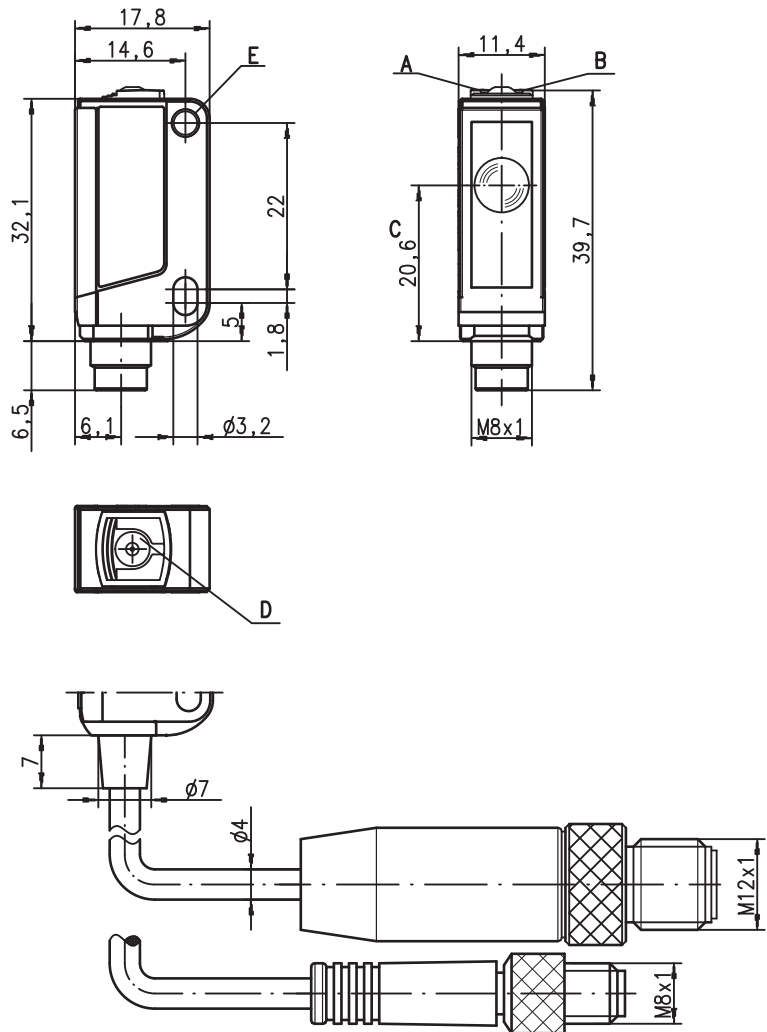

- A** Green indicator diode
- B** Yellow indicator diode
- C** Optical axis
- D** Teach button
- E** Mounting sleeve

**Electrical connection**

**Plug connector, 4-pin**

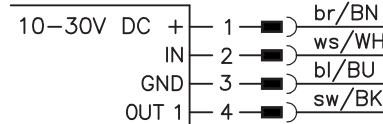

**Cable, 4-wire**

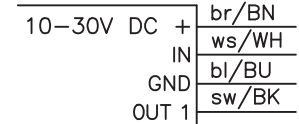

**Plug connector, 3-pin**

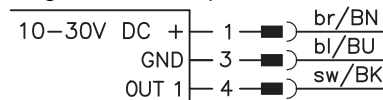

			<b>0 ... 3m</b>

- Polarized retro-reflective photoelectric sensor with autocollimation principle
- Small and compact construction with robust plastic housing, protection class IP 67 for industrial application
- Push-pull output with light/dark switching via teach-in button
- High switching frequency for detection of fast events and small parts
- Easy adjustment via lockable teach button or teach input
- Laser class 1

**Accessories:**

(available separately)

- Mounting systems (BT 3...)
- Cables with M8 or M12 connector (K-D ...)
- Reflectors
- Reflective tapes

We reserve the right to make changes • DS\_PRKL3B622\_en\_50105363\_02.fm

### Specifications (not valid for RKL 3B/6.22 !)

#### Optical data

Typ. op. range limit (MTKS 50 x 50) <sup>1)</sup>	0 ... 3m
Operating range <sup>2)</sup>	see tables
Light beam characteristic	collimated, ≤ 3mrad
Light spot diameter	approx. 2mm at light beam gate
Light source <sup>3)</sup>	laser (pulsed)
Laser class	1 in accordance with IEC 60825-1:2007
Wavelength	655nm (visible red light, polarized)
Max. output power	0.29mW
Pulse duration	≤ 5.5µs

#### Timing

Switching frequency	2,000Hz
Response time	0.25ms
Delay before start-up	≤ 300ms

#### Electrical data

Operating voltage $U_B$ <sup>4)</sup>	10 ... 30VDC (incl. residual ripple)
Residual ripple	≤ 15% of $U_B$
Open-circuit current	≤ 15mA
Switching output <sup>5)</sup>	.../6.22 1 push-pull switching output pin 4: PNP light switching, NPN dark switching pin 2: teach input
	.../6.2...-S8.3 1 push-pull switching output pin 4: PNP light switching, NPN dark switching pin 2: activation input
	.../4.28 1 PNP switching output, light switching, pin 2: activation input
Function characteristics	light/dark reversible
Signal voltage high/low	≥ ( $U_B - 2V$ )/≤ 2V
Output current	max. 100mA
Operating range	setting via teach-in

#### Indicators

Green LED	ready
Yellow LED	light path free
Yellow LED, flashing	light path free, no performance reserve <sup>6)</sup>

#### Mechanical data

Housing	plastic (PC-ABS); 1 attachment sleeve, nickel-plated steel
Optics cover	plastic (PMMA)
Weight	with connector: 10g with 200mm cable and connector: 20g with 2m cable: 50g
Connection type	2m cable (cross section 4x0.20mm <sup>2</sup> ), connector M8 metal, 0.2m cable with connector M8 or M12

#### Environmental data

Ambient temp. (operation/storage)	-40°C ... +55°C <sup>7)</sup> / -40°C ... +70°C
Protective circuit <sup>8)</sup>	2, 3
VDE safety class	III
Protection class	IP 67
Standards applied	IEC 60947-5-2
Certifications	UL 508, CSA C22.2 No.14-13 <sup>4) 9)</sup>

#### Options

##### Teach-in input/activation input

Transmitter active/not active	≥ 8V/≤ 2V
Activation/disable delay	≤ 1ms
Input resistance	30kΩ

- 1) Typ. operating range limit: max. attainable range without performance reserve
- 2) Operating range: recommended range with performance reserve
- 3) Average life expectancy 50,000h at an ambient temperature of 25°C
- 4) For UL applications: for use in class 2 circuits according to NEC only
- 5) The push-pull switching outputs must not be connected in parallel
- 6) Display "no performance reserve" as yellow flashing LED is only available in standard teach setting
- 7) Without mounting max. +50°C, with screw mounting on metal part up to +55°C permissible
- 8) 2=polarity reversal protection, 3=short circuit protection for all transistor outputs
- 9) These proximity switches shall be used with UL Listed Cable assemblies rated 30V, 0.5A min, in the field installation, or equivalent (categories: CYJV/CYJV7 or PVVA/PVVA7)

### Remarks

Adapter plate:

BT 3.2 (part no. 50103844) for alternate mounting on 25.4mm hole spacing (Omron E3Z, Sick W100...)

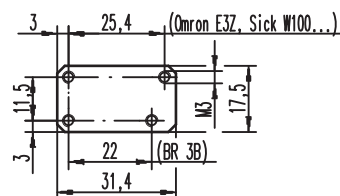

### Tables

Reflectors		Operating range	
1	MTKS 50x50.1	0 ... 2.0m	
2	MTKS 20x30	0 ... 1.6m	
3	MTKS 20x40.1	0 ... 1.0m	
4	Tape 6 50x50	0 ... 1.0m	
1	0	2.0	3.0
2	0	1.6	2.2
3	0	1.0	1.5
4	0	1.0	1.4

□ Operating range [m]  
 □ Typ. operating range limit [m]

MTKS ... = micro triple, screw type

### Remarks

#### Operate in accordance with intended use!

- ⚠ This product is not a safety sensor and is not intended as personnel protection.
- ⚠ The product may only be put into operation by competent persons.
- ⚠ Only use the product in accordance with the intended use.

#### UL REQUIREMENTS

Enclosure Type Rating: Type 1  
**For Use in NFPA 79 Applications only.**

Adapters providing field wiring means are available from the manufacturer. Refer to manufacturers information.

**CAUTION** – the use of controls or adjustments or performance of procedures other than those specified herein may result in hazardous radiation exposure.

**ATTENTION !** Si d'autres dispositifs d'alignement que ceux préconisés ici sont utilisés ou s'il est procédé autrement qu'indiqué, cela peut entraîner une exposition à des rayonnements et un danger pour les personnes.

#### Mounting system:





- ① = BT 3 (part no. 50060511)
- ②+③ = BT 3.1 <sup>1)</sup> (part no. 50105585)
- ①+②+③ = BT 3B (part no. 50105546)

1) Packaging unit: PU = 10 pcs.

# PRKL 3B Laser retro-reflective photoelectric sensor with polarization filter

## Order guide

Selection table				Order code →	PRKL 3B/6.22 Part No. 50104705	PRKL 3B/6.22-S8 Part No. 50104706	PRKL 3B/6D.22-S8 Part No. 50106475	PRKL 3B/6.22, 200-S8 Part No. 50104707	PRKL 3B/6.22, 200-S12 Part No. 50105764	PRKL 3B/6.2-S8.3 Part No. 50109484	PRKL 3B/6.2, 200-S8.3 on request	PRKL 3B/4.28-S8 on request	RKL 3B/6.22 <sup>1)</sup> Part No. 50106854	
Equipment ↓														
Output 1 (OUT 1)	push-pull switching output, configurable		light switching ○	● <sup>2)</sup>	● <sup>2)</sup>	●	● <sup>2)</sup>	● <sup>2)</sup>	● <sup>2)</sup>	● <sup>2)</sup>	● <sup>2)</sup>		● <sup>2)</sup>	
			dark switching ●	●	●	● <sup>2)</sup>	●	●	●	●	●		●	
	PNP transistor output		light switching ○										●	
			dark switching ●											
Input (IN)	teach input			●	●	●	●	●					●	
	activation input											●		
Connection	cable 2,000 mm		4-wire	●									●	
	M8 connector, metal		3-pin						●					
	M8 connector, metal		4-pin		●	●						●		
	200 mm cable with M8 connector		3-pin								●			
	200 mm cable with M8 connector		4-pin				●							
	200 mm cable with M12 connector		4-pin					●						
Configuration	Teach-in via button (lockable) and teach input			●	●	●	●	●					●	
	Teach-in via button								●	●	●			

1) Special type, prior to use, consult with the head office!

2) Presetting

**Laser safety notices – Laser class 1**



**ATTENTION, LASER RADIATION – LASER CLASS 1**

The device satisfies the requirements of IEC 60825-1:2007 (EN 60825-1:2007) safety regulations for a product in **laser class 1** as well as the U.S. 21 CFR 1040.10 regulations with deviations corresponding to "Laser Notice No. 50" from June 24th, 2007.

- ↳ Adhere to the applicable legal and local regulations regarding protection from laser beams.
- ↳ The device must not be tampered with and must not be changed in any way.
  - There are no user-serviceable parts inside the device.
  - Repairs must only be performed by Leuze electronic GmbH + Co. KG.

**General information**

- The laser retro-reflective photoelectric sensors PRKL 3B/... have an optimized light beam propagation in the typical range of application of 0 ... 1 m (not to be confused with the operating range, which is 0 ... 3 m in combination with a reflector MTKS 50x50.1). This permits the reliable recognition of the smallest of parts or the positioning of objects with maximum precision across the entire area.
- For foil 6, the sensor's side edge must be aligned parallel to the side edge of the reflective tape.
- The sensor is constructed on the basis of the autocollimation principle, i.e., light being transmitted and light being received propagate along the same light axis. This permits the photoelectric sensor to be installed directly behind small holes or diaphragms. The smallest permissible diaphragm diameter for secure functioning is 3mm.

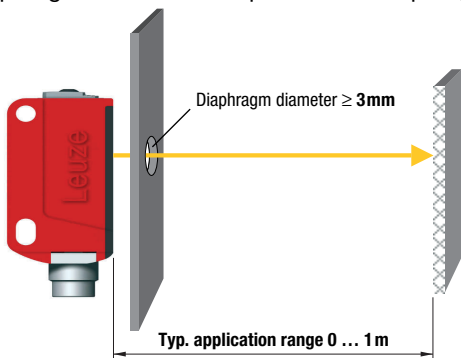

- The achievable resolution depends significantly on the unit's configuration. Depending on the teach mode, the following values are possible:

Setting	Detection from object size <sup>1)</sup>
max. operating range (factory setting)	1.5 mm
normal sensor sensitivity (standard teaching)	1 mm
maximum sensor sensitivity (dynamic teaching)	0.1 ... 0.2 mm

1) All specifications are typical values and may vary by a small amount for each unit.

- For safety reasons, the laser transmitter is equipped with a monitor, which automatically switches off the transmitter in case of a component defect. In case of failure, the yellow LED flashes rapidly and the green LED is off. The state is irreversible and the sensor must be exchanged.

**PRKL 3B Laser retro-reflective photoelectric sensor with polarization filter**

**Sensor adjustment (teach) via teach button**



- **Prior to teaching:**  
**Clear the light path to the reflector!**  
The device setting is stored in a fail-safe way. A reconfiguration following voltage interruption or switch-off is thus not required.

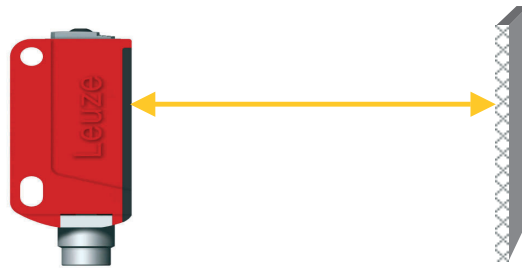

**Standard teaching for average sensor sensitivity**

- Press teach button until both LEDs flash **simultaneously**.
- Release teach button.
- Ready.



After standard teaching, the sensor switches for objects with a minimum size of 1 mm (see table under "General Information").

If both LEDs flash rapidly after the teaching event, a teaching error has happened. Please check the alignment of the light beam onto the reflector and carry out another teaching event.

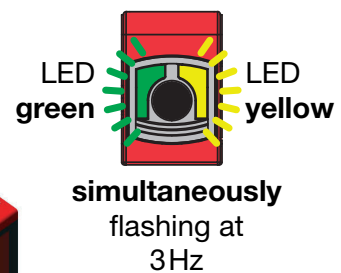
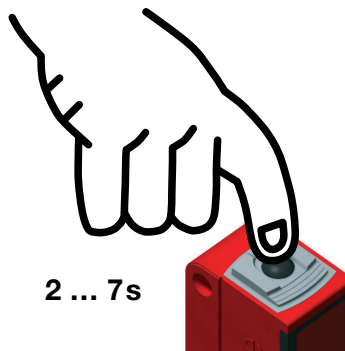

**Teaching for maximal sensor sensitivity (dynamic teaching)**

- Press teach button until both LEDs flash **alternatingly**. Sensor remains in teaching mode even after the teach button has been released.
- Move some objects through the light path or swing a single object slowly back and forth through the light path.
- Briefly press the teach button to terminate the teach event.
- Ready.



After teaching for maximum sensor sensitivity, the sensor switches for objects with a minimum size of 0.1 ... 0.2 mm (see table under "General Information").

If both LEDs flash rapidly after the teaching event, a teaching error has happened. Please check the alignment of the light beam onto the reflector and carry out another teaching event.

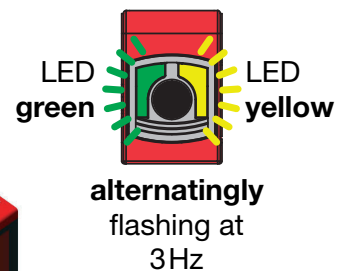
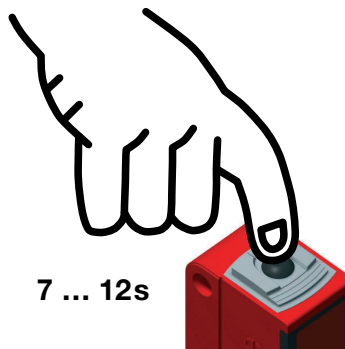

***Teaching for maximum operating range (factory setting at delivery)***

- Prior to teaching:  
**Cover** the light path to the reflector!
- Procedure as for standard teaching.

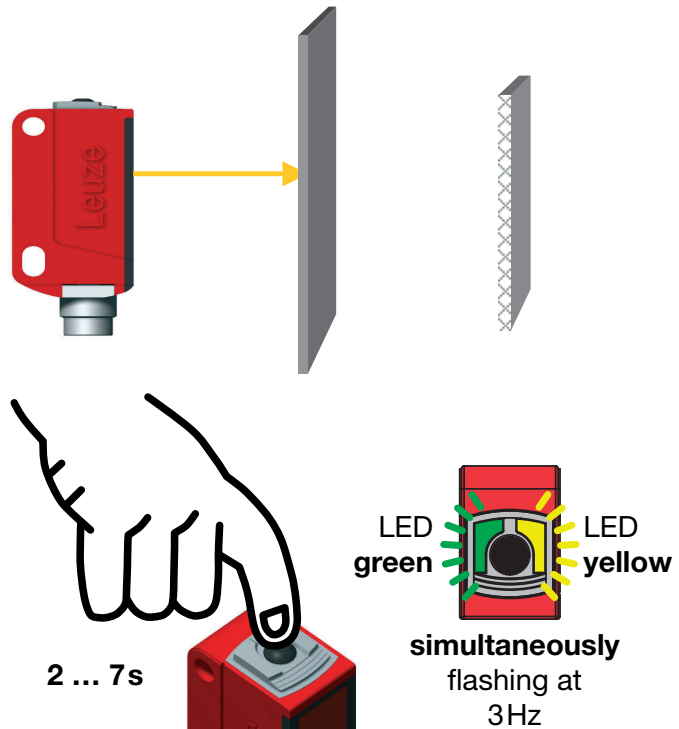

***Adjusting the switching behavior of the switching output – light/dark switching***

- Press teach button until the green LED flashes. The yellow LED displays the current setting of the switching output:  
ON = output switches on light  
OFF = output switches on dark
- Continue to press the teach button in order to change the switching behavior.
- Release teach button.
- Ready.

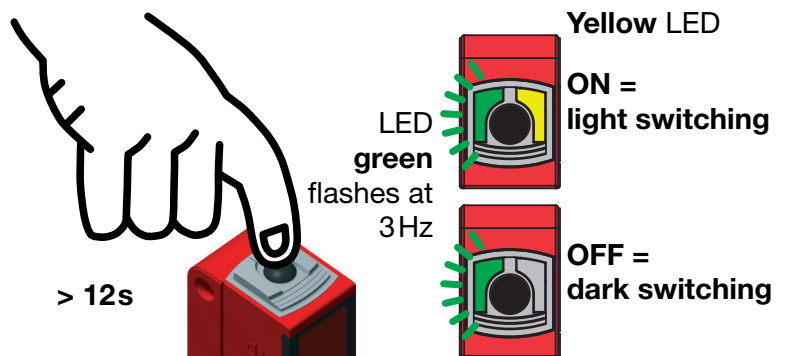

**PRKL 3B Laser retro-reflective photoelectric sensor with polarization filter**

**Locking the teach button via the teach input**



A **static high signal** ( $\geq 4$  ms) at the teach input locks the teach button on the device if required, such that no manual operation is possible (e.g., protection from erroneous operation or manipulation).

If the teach input is not connected or if there is a static low signal, the button is unlocked and can be operated freely.

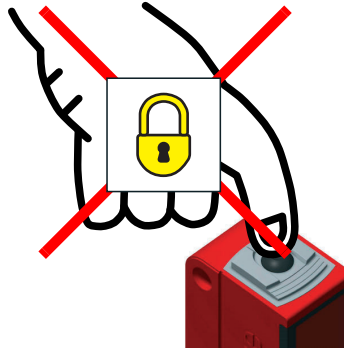

**Sensor adjustment (teach) via teach input**



The following description applies to PNP switching logic!

$U_{\text{Teach low}} \leq 2V$

$U_{\text{Teach high}} \geq (U_B - 2V)$

**Prior to teaching: Clear the light path to the reflector!**

The device setting is stored in a fail-safe way. A reconfiguration following voltage interruption or switch-off is thus not required.

**Standard teaching for average sensor sensitivity**

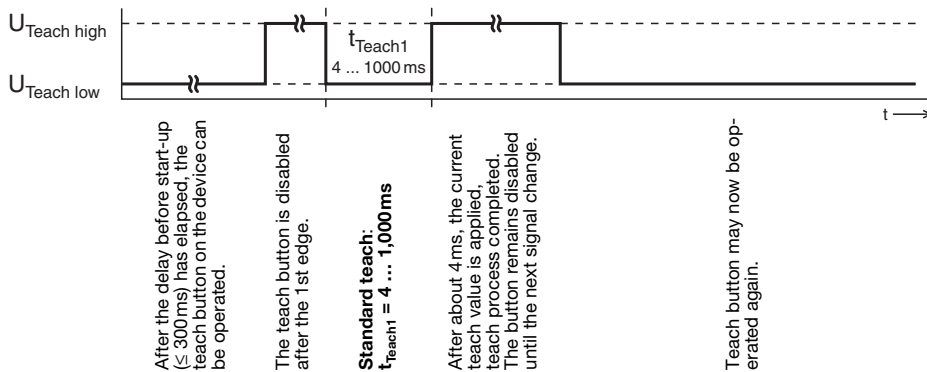

**Quick standard teach**

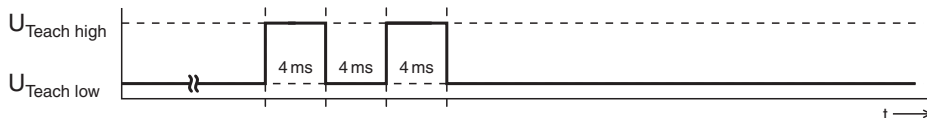

**Shortest teaching duration for standard teaching: approx. 12ms**



After standard teaching, the sensor switches for objects with a minimum size of 1 mm (see table under "General Information").

**Teaching for maximal sensor sensitivity (dynamic teaching)**

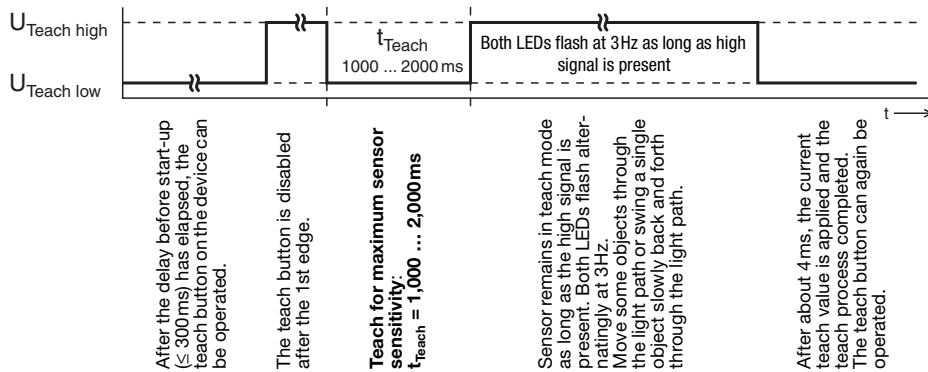

After the delay before start-up ( $\leq 300ms$ ) has elapsed, the teach button on the device can be operated.

The teach button is disabled after the 1st edge.

**Teach for maximum sensor sensitivity:**  
 $t_{Teach} = 1,000 \dots 2,000ms$

Sensor remains in teach mode as long as the high signal is present. Both LEDs flash alternately at 3Hz. Move some objects through the light path or swing a single object slowly back and forth through the light path.

After about 4ms, the current teach value is applied and the teach process completed. The teach button can again be operated.

In the event of a teach error (e.g. no teach object or a teach object which is too small or too transparent is moved through the light path), the two LEDs flash at the same rate. Check the system, repeat the teach process, if necessary use a larger or less transparent teach object.



After teaching for maximum sensor sensitivity, the sensor switches for objects with a minimum size of 0.1 ... 0.2mm (see table under "General Information").

**Adjusting the switching behavior of the switching output – light/dark switching**

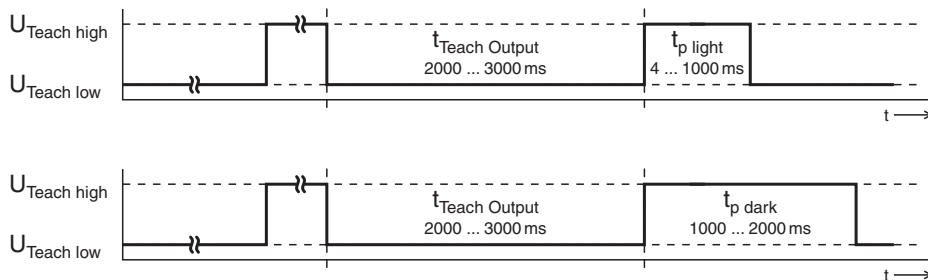

After the delay before start-up ( $\leq 300ms$ ) has elapsed, the teach button on the device can be operated.

The teach button is disabled after the 1st edge.

**Setting the switching behavior of the switching output:**  
 $t_{Teach\ Output} = 2,000 \dots 3,000ms$

**Switching output switches on light:**  
 $t_{p\ light} = 4 \dots 1,000ms$

**Switching output switches on dark:**  
 $t_{p\ dark} = 1,000 \dots 2,000ms$

The button remains disabled until the next signal change.