

PRKL 25B

Laser retro-reflective photoelectric sensor with polarization filter

en 06-2016/03 50108919-03



0.05 ... 15m
10 - 30 V DC
A²LS
CDRH

- Polarized retro-reflective photoelectric sensor with visible red laser light
- High performance reserve
- Small and compact construction with robust plastic housing, degree of protection IP 66/IP 67 for industrial application
- A²LS - Active Ambient Light Suppression
- Push-pull switching outputs
- High switching frequency for detection of fast events and small parts
- Warning output for increased availability
- Optimized light beam propagation for the detection of small objects.
- Operating range adjustment

Accessories:

(available separately)

- Mounting systems (BT 25, UMS 25...)
- Cable with M8 or M12 connector (K-D ...)
- Reflectors
- Reflective tapes

Dimensioned drawing

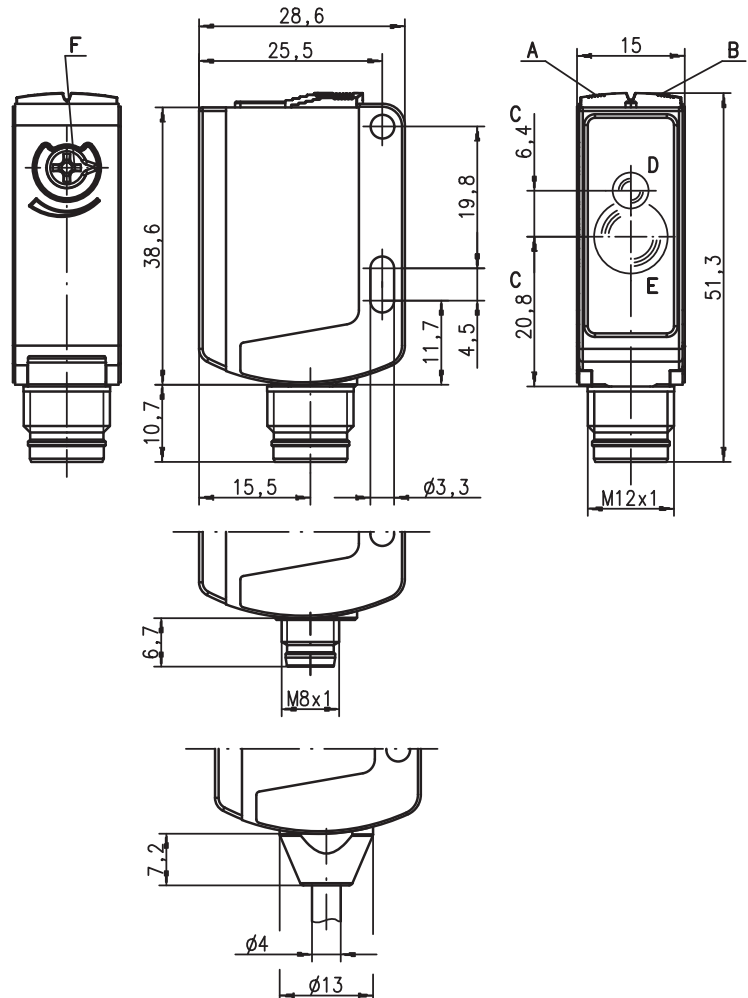

- A Green indicator diode
- B Yellow indicator diode
- C Optical axis
- D Transmitter
- E Receiver
- F Operating range adjustment

Electrical connection

PRKL 25B/66.1-S8
PRKL 25B/66.1-S12

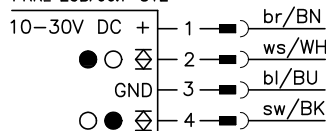

PRKL 25B/66.1

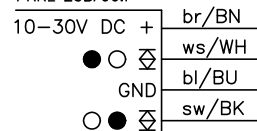

PRKL 25B/6.81-S12

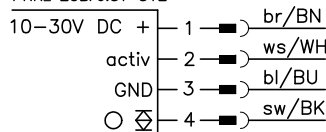

PRKL 25B/4.1, 200-S12

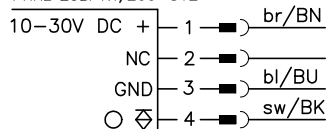

PRKL 25B/4D.1-S12

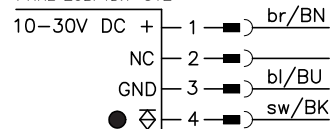

We reserve the right to make changes • DS_PRKL25B466_en_50108919_03.fm

Specifications

Optical data

Typ. op. range limit (MTKS 50 x 50) ¹⁾	0.05 ... 15m
Operating range ²⁾	see tables
Light beam characteristic	collimated
Light spot diameter	3x5mm ² at 1m, 10x20mm ² at 10m
Light source ³⁾	laser (pulsed)
Laser class	2 in accordance with IEC 60825-1:2007
Wavelength	655nm (visible red light, polarized)
Max. output power (peak)	1.5mW
Pulse duration	8.1µs

Timing

Switching frequency	2,000Hz
Response time	0.25ms
Delay before start-up	≤ 300ms

Electrical data

Operating voltage U _B ⁴⁾	10 ... 30VDC (incl. residual ripple)
Residual ripple	≤ 15% of U _B
Open-circuit current	≤ 20mA
Switching output ⁵⁾	2 push-pull switching outputs pin 2: PNP dark switching, NPN light switching pin 4: PNP light switching, NPN dark switching 1 push-pull switching output pin 4: PNP light switching, NPN dark switching 1 activation input
	.../66.1
	.../6.81
	.../4.1
	.../4D.1
Function	1 PNP switching output light switching, pin 2: not connected ⁶⁾ 1 PNP switching output dark switching, pin 2: not connected ⁶⁾ light/dark switching
Signal voltage high/low	≥ (U _B -2V)/≤ 2V
Output current	max. 100mA
Operating range	adjustable with potentiometer

Indicators

Green LED	ready
Yellow LED	light path free
Yellow LED, flashing	light path free, no performance reserve

Mechanical data

Housing	plastic (PC-ABS)
Optics cover	plastic (PMMA)
Weight	with connector: 15g with 2m cable: 55g
Connection type	cable 2m (cross section 3x0.20mm ²), M8 or M12 connector

Environmental data

Ambient temp. (operation/storage) ⁷⁾	-40°C ... +40°C/-40°C ... +60°C
Protective circuit ⁸⁾	2, 3
VDE safety class ⁹⁾	II
Degree of protection	IP 66, IP 67
Standards applied	IEC 60947-5-2
Certifications	UL 508, C22.2 No.14-13 ⁴⁾ ⁷⁾ ¹⁰⁾

Options

Activation input activ	
Transmitter active/not active	≥ 8V/≤ 2V
Activation/disable delay	≤ 1ms
Input resistance	10KΩ ± 10%

- 1) Typ. operating range limit: max. attainable range without performance reserve
- 2) Operating range: recommended range with performance reserve
- 3) Average life expectancy 50,000h at an ambient temperature of 25°C
- 4) For UL applications: for use in class 2 circuits according to NEC only
- 5) The push-pull switching outputs must not be connected in parallel
- 6) Pin 2: unassigned, hence especially suitable for the connection to AS-interface I/O coupling modules
- 7) UL certified in the temperature range -10°C to 40°C
- 8) 2=polarity reversal protection, 3=short circuit protection for all transistor outputs
- 9) Rating voltage 50V
- 10) These proximity switches shall be used with UL Listed Cable assemblies rated 30V, 0.5A min, in the field installation, or equivalent (categories: CYJV/CYJV7 or PVVA/PVVA7)

Tables

Reflectors		Operating range	
1	TK(S) 100x100	0.30 ... 12.0m	
2	MTKS 50x50	0.05 ... 12.0m	
3	MTKS 20x20	0.05 ... 6.0m	
1	0.30	12	15
2	0.05	12	15
3	0.05	6	7

□ Operating range [m]
 □ Typ. operating range limit [m]

TK ... = adhesive
 TKS ... = screw type
 MTKS ... = micro triple, screw type

Diagrams

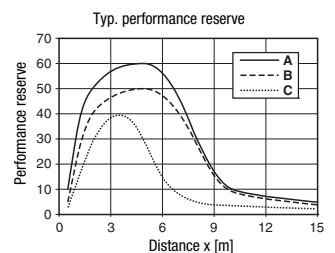
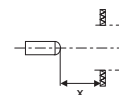
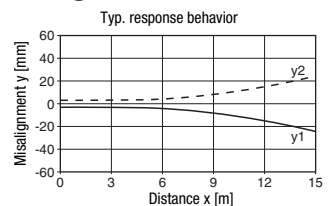

- A TK(S) 100x100
- B MTKS 50x50
- C MTKS 20x20

Remarks

Operate in accordance with intended use!

- ⚠ This product is not a safety sensor and is not intended as personnel protection.
- ⚠ The product may only be put into operation by competent persons.
- ⚠ Only use the product in accordance with the intended use.

UL REQUIREMENTS

Enclosure Type Rating: Type 1

For Use in NFPA 79 Applications only.

Adapters providing field wiring means are available from the manufacturer. Refer to manufacturers information.

CAUTION – the use of controls or adjustments or performance of procedures other than those specified herein may result in hazardous radiation exposure.

ATTENTION ! Si d'autres dispositifs d'alignement que ceux préconisés ici sont utilisés ou s'il est procédé autrement qu'indiqué, cela peut entraîner une exposition à des rayonnements et un danger pour les personnes.

PRKL 25B
Laser retro-reflective photoelectric sensor with polarization filter
Order guide

Selection table							
Order code →							
Equipment ↓							
		PRKL 25B/66.1-S12 Part no. 50104231	PRKL 25B/4D.1-S12 Part no. 50104232	PRKL 25B/6.81-S12 Part no. 50104233	PRKL 25B/66.1-S8 Part no. 50104234	PRKL 25B/66.1 Part no. 50104235	PRKL 25B/4.1-200-S12 Part no. 50110921
Switching output	2 x push-pull switching output	●			●	●	
	1 x push-pull switching output			●			
	1 x PNP output		●				●
Switching function	1 PNP light switching and NPN dark switching output	●			●	●	
	1 PNP dark switching and NPN light switching output	●			●	●	
	1 PNP light switching and NPN light switching output			●			
	1 x PNP light switching output						●
	1 x PNP dark switching output		●				
Connection	M8 connector, 4-pin				●		
	M12 connector, 4-pin	●	●	●			
	cable 2,000mm					●	
	M12 metal connector, 4-pin, with 200mm cable tail						●
Indicators	green LED: ready	●	●	●	●	●	●
	yellow LED: light path free	●	●	●	●	●	●
Options	operating range adjustment via potentiometer	●	●	●	●	●	●
	activation input			●			
	for direct connection to AS-i I/O coupling modules (pin 2 not assigned)		●				●
	High performance reserve	●	●	●	●	●	●

Laser safety notices

 **ATTENTION, LASER RADIATION – LASER CLASS 2**

Never look directly into the beam!

The device satisfies the requirements of IEC 60825-1:2007 (EN 60825-1:2007) safety regulations for a product in **laser class 2** as well as the U.S. 21 CFR 1040.10 regulations with deviations corresponding to "Laser Notice No. 50" from June 24th, 2007.

- ↳ Never look directly into the laser beam or in the direction of reflecting laser beams!
If you look into the beam path over a longer time period, there is a risk of injury to the retina.
- ↳ Do not point the laser beam of the device at persons!
- ↳ Intercept the laser beam with an opaque, non-reflective object if the laser beam is accidentally directed towards a person.
- ↳ When mounting and aligning the device, avoid reflections of the laser beam off reflective surfaces!
- ↳ **CAUTION!** Use of controls or adjustments or performance of procedures other than specified herein may result in hazardous light exposure.
- ↳ Adhere to the applicable legal and local regulations regarding protection from laser beams.
- ↳ The device must not be tampered with and must not be changed in any way.
There are no user-serviceable parts inside the device.
Repairs must only be performed by Leuze electronic GmbH + Co. KG.

NOTICE

Affix laser information and warning signs!

Laser information and warning signs are affixed to the device (see ①). In addition, self-adhesive laser information and warning signs (stick-on labels) are supplied in several languages (see ②).

- ↳ Affix the laser information sheet with the language appropriate for the place of use to the device.
When using the device in the US, use the stick-on label with the "Complies with 21 CFR 1040.10" notice.
- ↳ Affix the laser information and warning signs near the device if no signs are attached to the device (e.g. because the device is too small) or if the attached laser information and warning signs are concealed due to the installation position.
Affix the laser information and warning signs so that they are legible without exposing the reader to the laser radiation of the device or other optical radiation.

①

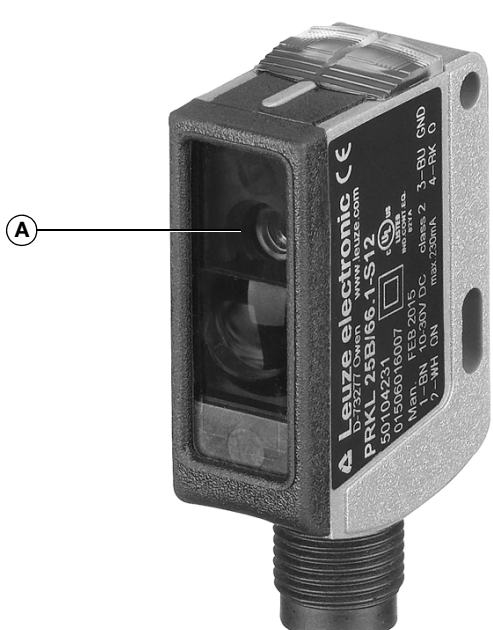

A Laser exit opening

②

50105324-03

LASERSTRAHLUNG	
NICHT IN DEN STRAHL BLICKEN	
Max. Leistung (peak):	1,5 mW
Impulsdauer:	8,1 µs
Wellenlänge:	655 nm
LASER KLASSE 2	
<small>DIN EN 60825-1:2008-05</small>	

RADIAZIONE LASER	
NON FISSARE IL FASCIO	
Potenza max. (peak):	1,5 mW
Durata dell'impulso:	8,1 µs
Lunghezza d'onda:	655 nm
APPARECCHIO LASER DI CLASSE 2	
<small>EN 60825-1:2007</small>	

LASER RADIATION	
DO NOT STARE INTO BEAM	
Maximum Output (peak):	1,5 mW
Pulse duration:	8,1 µs
Wavelength:	655 nm
CLASS 2 LASER PRODUCT	
<small>EN 60825-1:2007</small>	

AVOID EXPOSURE - LASER RADIATION IS EMITTED FROM THIS APERTURE

RAYONNEMENT LASER	
NE PAS REGARDER DANS LE FASCIEAU	
Puissance max. (crête):	1,5 mW
Durée d'impulsion:	8,1 µs
Longueur d'onde:	655 nm
APPAREIL A LASER DE CLASSE 2	
<small>EN 60825-1:2007</small>	

EXPOSITION DANGEREUSE - UN RAYONNEMENT LASER EST ÉMIS PAR CETTE OUVERTURE

RADIACIÓN LASER	
NO MIRAR FLUJENTE AL HAZ	
Potencia máx. (peak):	1,5 mW
Duración del impulso:	8,1 µs
Longitud de onda:	655 nm
PRODUCTO LASER DE CLASE 2	
<small>EN 60825-1:2007</small>	

RADIACÃO LASER	
NÃO OLHAR FIXAMENTE O FEIXE	
Potência máx. (peak):	1,5 mW
Período de pulso:	8,1 µs
Comprimento de onda:	655 nm
EQUIPAMENTO LASER CLASSE 2	
<small>EN 60825-1:2007</small>	

LASER RADIATION	
DO NOT STARE INTO BEAM	
Maximum Output (peak):	1,5 mW
Pulse duration:	8,1 µs
Wavelength:	655 nm
CLASS 2 LASER PRODUCT	
<small>IEC 60825-1:2007</small>	
<small>Complies with 21 CFR 1040.10</small>	

激光辐射	
勿直视光束	
最大输出 (峰值):	1,5 mW
脉冲持续时间:	8,1 µs
波长:	655 nm
2 类激光产品	
<small>GB7247.1-2012</small>	

