

PRK 5 Retro-reflective photoelectric sensors for semi-transparent media

en 02-2015/09 50128357

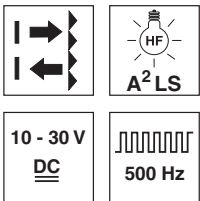

0.02 ... 6.0m

- Polarized retro-reflective photoelectric sensor using visible red light
- Easy adjustment via teach button
- Active suppression of extraneous light A²LS
- Fast alignment through *brightVision*®
- Simple mounting with integrated M3 metal threaded sleeves
- Compact installation possible due to cable outlet at the rear or bottom
- Robust plastic housing acc. to IP 67 for industrial application
- Full control through green and yellow indicator LEDs
- Complementary outputs for light/dark switching

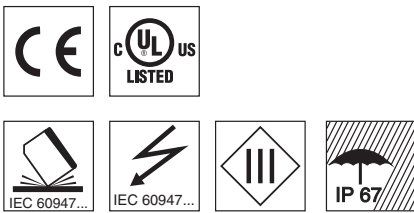

Accessories:

(available separately)

- Mounting systems (BTU 200 ..., BT 200..., BT 205M)
- M12 connectors (KD ...)
- Ready-made cables (K-D ...)
- Reflectors
- Reflective tape

Dimensioned drawing

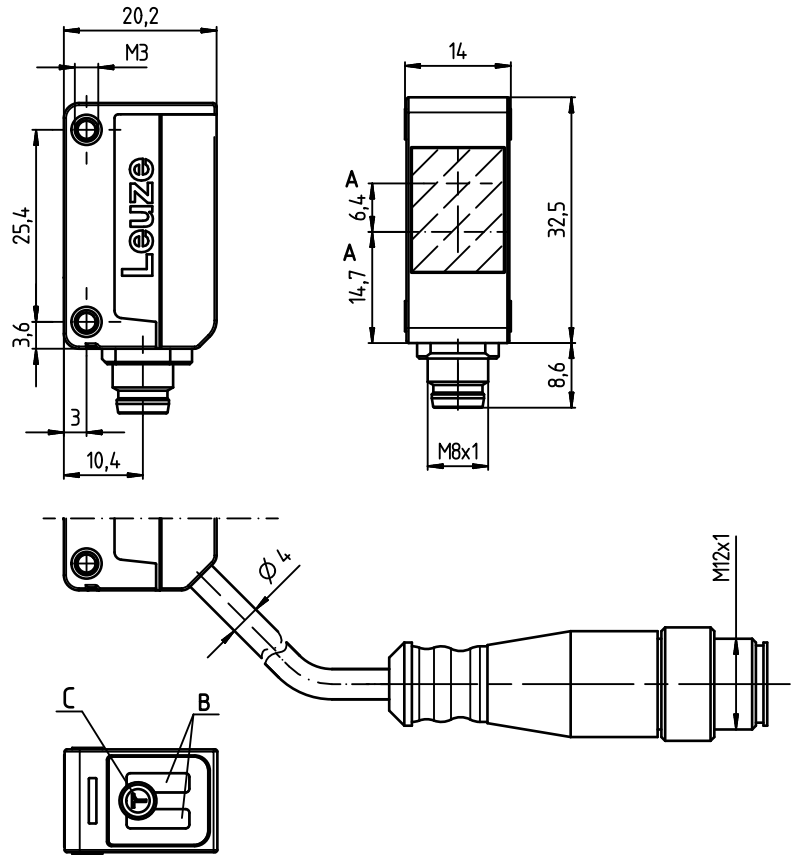

- A** Optical axes
- B** Indicator diode
- C** Teach button

Electrical connection

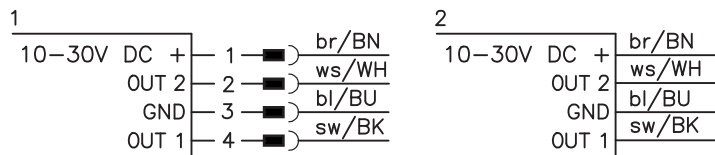

We reserve the right to make changes • DS_PRK5M3_en_50128357.fm

Specifications

Optical data

Typ. op. range limit (TK(S) 100x100) ¹⁾	0.02 ... 6.0 m
Operating range ²⁾	see tables
Light source	LED (modulated light)
Wavelength	620nm (visible red light, polarized)

Timing

Switching frequency	500Hz
Response time	1 ms
Delay before start-up	≤ 300ms

Electrical data

Operating voltage U_B ³⁾	10 ... 30VDC
Residual ripple	≤ 15% of U_B
Open-circuit current	≤ 20mA
Switching output	.../4P... 2 PNP transistor outputs pin 2: PNP dark switching, pin 4: PNP light switching
	.../2N... 2 NPN transistor outputs pin 2: NPN dark switching, pin 4: NPN light switching
Signal voltage high/low	≥ ($U_B - 2.5V$) / ≤ 2.5V
Output current	max. 100mA ⁴⁾

Indicators

Green LED	ready
Yellow LED	light path free
Yellow LED, flashing	light path free, no performance reserve

Mechanical data

Housing	plastic
Optics cover	plastic
Weight	20g with M8 connector 70g with 2m cable
Connection type	M8 connector, 4-pin cable 2m, 4x0.20mm ²

Environmental data

Ambient temp. (operation/storage)	-40°C ... +60°C / -40°C ... +70°C
Protective circuit ⁵⁾	2, 3
VDE safety class	III
Protection class	IP 67
Light source	exempt group (in acc. with EN 62471)
Standards applied	IEC 60947-5-2
Certifications	UL 508, C22.2 No.14-13 ³⁾ ⁶⁾

- 1) Typ. operating range limit: max. attainable range without performance reserve
- 2) Operating range: recommended range with performance reserve
- 3) For UL applications: for use in class 2 circuits according to NEC only
- 4) Sum of the output currents for both outputs, 50mA when ambient temperatures > 40°C
- 5) 2=polarity reversal protection, 3=short circuit protection for all outputs
- 6) These proximity switches shall be used with UL Listed Cable assemblies rated 30V, 0.5A min, in the field installation, or equivalent (categories: CYJV/CYJV7 or PVVA/PVVA7)

Tables

Reflectors			Operating range
1	TK(S)	100x100	0.02 ... 4.5m
2	TKS	40x60	0.02 ... 3.0m
3	TKS	82.2	0.05 ... 3.6m
4	TKS	30x50	0.03... 1.9m
5	TKS	20x40	0.04 ... 1.6m
6	Tape 4	50x50	0.08 ... 1.4m

1	0.02	4.5	6.0
2	0.02	3.0	4.0
3	0.05	3.6	4.5
4	0.03	1.9	2.5
5	0.04	1.6	2.2
6	0.08	1.4	2.0

□ Operating range [m]
 □ Typ. operating range limit [m]

Diagrams

Typ. response behavior (TK 100x100)

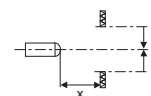
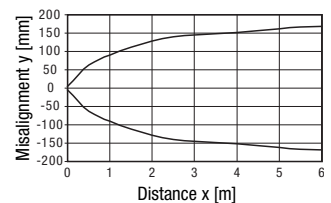

Typ. performance reserve

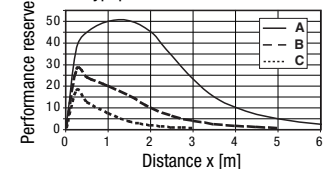

- A TKS 100x100
- B TKS 40x60
- C TKS 20x40

Remarks

Operate in accordance with intended use!

- ⚠ This product is not a safety sensor and is not intended as personnel protection.
- ⚠ The product may only be put into operation by competent persons.
- ⚠ Only use the product in accordance with the intended use.

PRK 5 Retro-reflective photoelectric sensors for semi-transparent media

Order guide

The sensors listed here are preferred types; current information at www.leuze.com.

		Designation	Part no.
With M8 connector	Pin 4: PNP light switching, pin 2: PNP dark switching	PRK5.M3/4P-M8	50128200
	Pin 4: NPN light switching, pin 2: NPN dark switching	PRK5.M3/2N-M8	50128202
With cable, 2m	Pin 4: PNP light switching, pin 2: PNP dark switching	PRK5.M3/4P	50128201
	Pin 4: NPN light switching, pin 2: NPN dark switching	PRK5.M3/2N	50128203

Part number code

P R K 5 . M 3 / 4 P - M 8

Operating principle	
PRK	Polarized retro-reflective photoelectric sensor
Series	
5	5 Series
Optics design	
.M3	For semi-transparent objects, Teach-in via teach button
Switching output/function /OUT1OUT2 (OUT1 = Pin 4, OUT2 = Pin 2)	
4	PNP transistor output, light switching
P	PNP transistor output, dark switching
2	NPN transistor output, light switching
N	NPN transistor output, dark switching
X	Pin not used
Combinations of functions are possible via two-digit code!	
Electrical connection	
N/A	Cable, standard length 2000 mm
-M8	M8 connector

Sensor adjustment (teach) via teach button



- **The sensor is factory-adjusted for maximum operating range.**
Recommendation: teach only if the desired objects are not reliably detected.
- **Prior to teaching: Clear the light path to the reflector!**
The device setting is stored in a fail-safe way. A reconfiguration following voltage interruption or switch-off is thus not required.

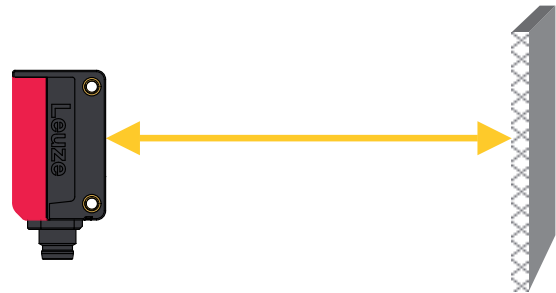

Teaching for increased sensor sensitivity

- Press teach button until both LEDs flash **simultaneously**.
- Release teach button.
- Ready.

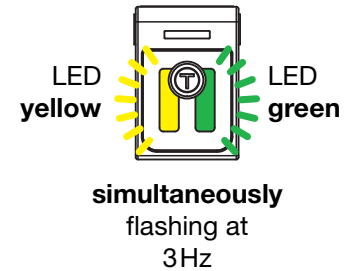
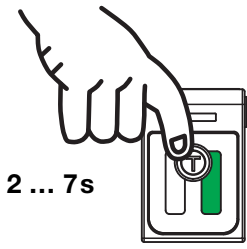

After the teaching for increased sensor sensitivity, the sensor switches when about 25 % of the light beam are covered by the object.

Standard teaching for average sensor sensitivity

- Press teach button until both LEDs flash **alternatingly**.
- Release teach button.
- Ready.



After the standard teaching, the sensor switches when half of the light beam is covered by the object.

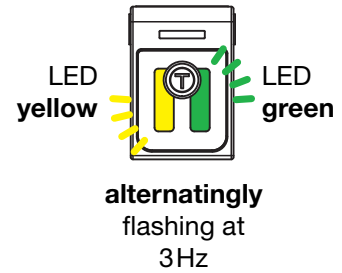
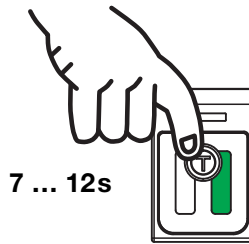

Teaching for maximum operating range (factory setting at delivery)

- **Prior to teaching:** Cover the light path to the reflector!
- Procedure as for Teaching for increased sensor sensitivity.

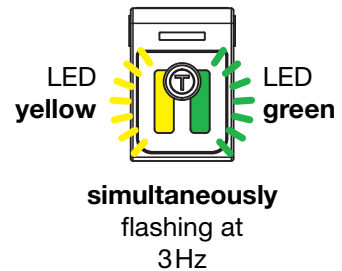
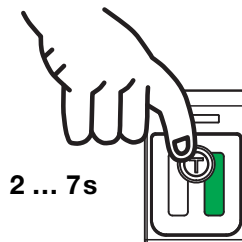
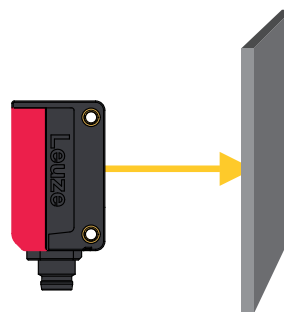

Adjusting the switching behavior of the switching output – light/dark switching

This function permits inversion of the sensors' switching logic.

- Press the teach button until only the green LED flashes. The yellow LED then shows the inverted switching logic:

ON = switching outputs light switching (in the case of complementary sensors, Q1 (pin 4) light switching, Q2 (pin 2) dark switching), this means output active when object is detected.

OFF = switching outputs dark switching (in the case of complementary sensors, Q1 (pin 4) dark switching, Q2 (pin 2) light switching), this means output inactive when object is detected.

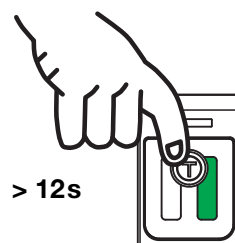

LED yellow
ON = light switching

OFF = dark switching



LED green flashes with 3Hz

- Release teach button.
- Ready.