



Figure can vary

Part no.: 50137057

PRK3C.T3/P-M8.3

Polarized retro-reflective photoelectric sensor



Contents

- Technical data
- Reflectors & reflective tapes
- Dimensioned drawings
- Electrical connection
- Diagrams
- Operation and display
- Accessories
- Notes



Technical data

Basic data	
Series	3C
Operating principle	Reflection principle
Application	Detection of highly transparent bottles
Special design	
Special design	Autocollimation
Optical data	
Operating range	Guaranteed operating range
Operating range	0 ... 3 m, With reflector TK(S) 100x100
Operating range limit	Typical operating range
Operating range limit	0 ... 3.6 m, With reflector TK(S) 100x100
Light source	LED, Red
LED light wavelength	635 nm
Transmitted-signal shape	Pulsed
LED protection class	Exempt group (in acc. with EN 62471)
Electrical data	
Protective circuit	Polarity reversal protection Short circuit protected
Performance data	
Supply voltage	10 ... 30 V, DC, Incl. residual ripple
Residual ripple	0 ... 15 %, From U_B
Open-circuit current	0 ... 15 mA
Outputs	
Number of digital switching outputs	1 Piece(s)
Switching outputs	
Voltage type	DC
Switching current, max.	100 mA
Switching voltage	High: $\geq(U_B-2V)$ Low: $\leq 2V$
Switching output 1	
Assignment	Connection 1, pin 4
Switching element	Transistor, PNP
Switching principle	Dark switching
Timing	
Switching frequency	1,500 Hz
Response time	0.33 ms
Readiness delay	300 ms
Response jitter	110 μ s
Connection	

Part no.: 50137057 – PRK3C.T3/P-M8.3 – Polarized retro-reflective photoelectric
Connection 1

Type of connection	Connector
Function	Signal OUT Voltage supply
Thread size	M8
Type	Male
Material	Metal
No. of pins	3 -pin

Mechanical data

Design	Cubic
Dimension (W x H x L)	11.4 mm x 34.2 mm x 18.3 mm
Housing material	Plastic, PC-ABS
Lens cover material	Plastic / PMMA
Net weight	10 g
Housing color	Red
Type of fastening	Through-hole mounting Via optional mounting device
Compatibility of materials	ECOLAB

Operation and display

Type of display	LED
Number of LEDs	2 Piece(s)
Operational controls	Teach button
Function of the operational control	Scanning range adjustment

Environmental data

Ambient temperature, operation	-40 ... 60 °C
Ambient temperature, storage	-40 ... 70 °C







Certifications

Degree of protection	IP 67 IP 69K
Protection class	III
Certifications	c UL US
Standards applied	IEC 60947-5-2

Classification

eCl@ss 8.0	27270902
eCl@ss 9.0	27270902
ETIM 5.0	EC002717

Reflectors & reflective tapes

	Part no.	Designation	Operating range/ Operating range limit	Description
	50117583	MTKS 50x50.1	0 ... 1.3 m 0 ... 1.6 m	Design: Rectangular Reflective surface: 50 mm x 50 mm Material: Plastic Base material: Plastic Chemical designation of the material: PMMA8N Fastening: Through-hole mounting, Adhesive
	50110192	REF 6-A-50x50	0 ... 1.2 m 0 ... 1.4 m	Design: Rectangular Reflective surface: 50 mm x 50 mm Material: Plastic Chemical designation of the material: PMMA Fastening: Self-adhesive
	50003192	TK 100x100	0 ... 3 m 0 ... 3.6 m	Design: Rectangular Reflective surface: 96 mm x 96 mm Triple reflector size: 4 mm Material: Plastic Base material: Plastic Chemical designation of the material: PMMA8N Fastening: Adhesive
	50022816	TKS 100X100	0 ... 3 m 0 ... 3.6 m	Design: Rectangular Reflective surface: 96 mm x 96 mm Triple reflector size: 4 mm Material: Plastic Base material: Plastic Chemical designation of the material: PMMA8N Fastening: Through-hole mounting, Adhesive
	50081283	TKS 20X40	0 ... 1 m 0 ... 1.2 m	Design: Rectangular Reflective surface: 16 mm x 38 mm Triple reflector size: 2.3 mm Material: Plastic Base material: Plastic Chemical designation of the material: PMMA8N Fastening: Through-hole mounting, Adhesive
	50040820	TKS 40X60	0 ... 2 m 0 ... 2.4 m	Design: Rectangular Reflective surface: 37 mm x 56 mm Triple reflector size: 4 mm Material: Plastic Base material: Plastic Chemical designation of the material: PMMA8N Fastening: Through-hole mounting, Adhesive

Dimensioned drawings

All dimensions in millimeters

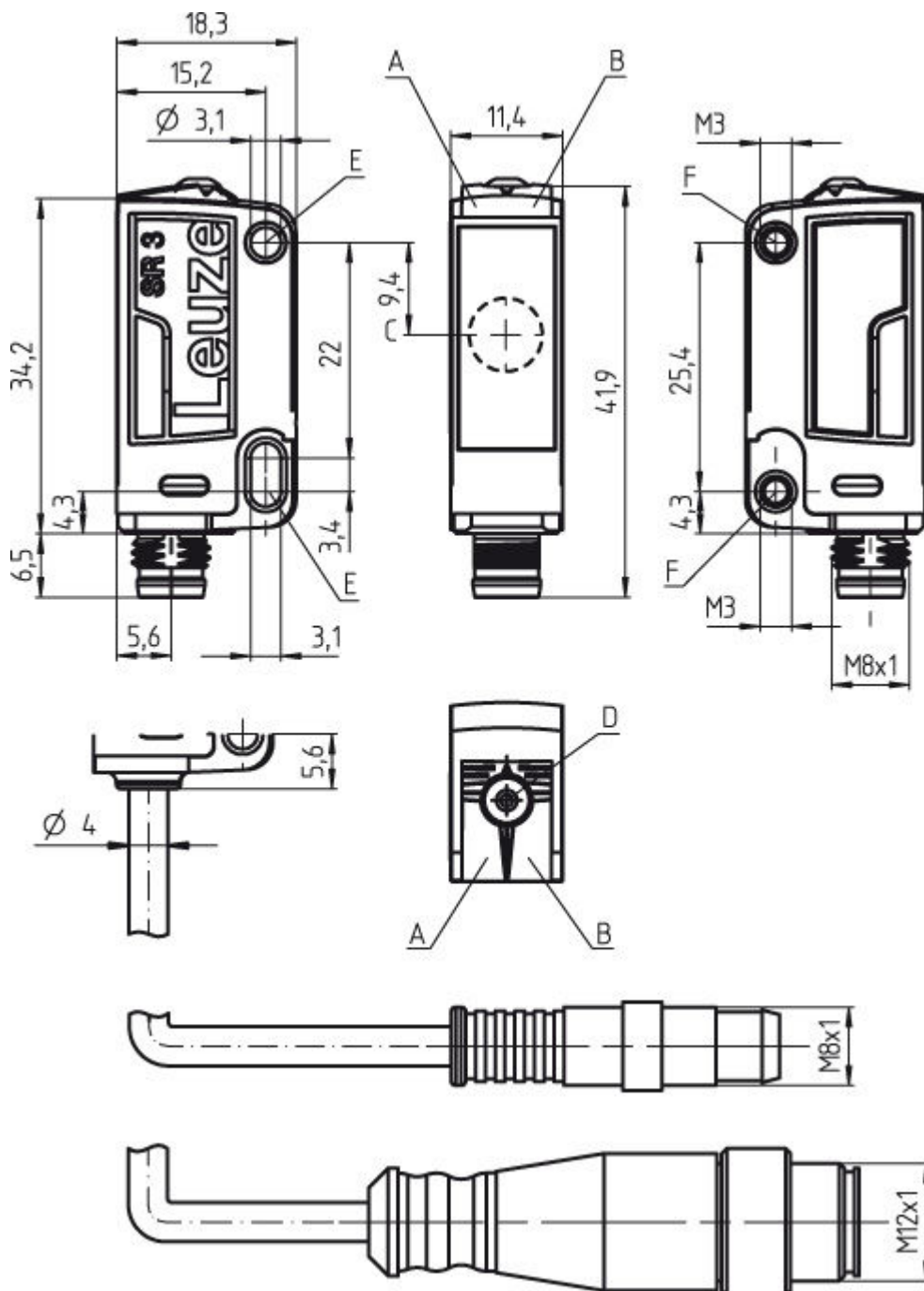

- A Green LED
- B Yellow LED
- C Optical axis
- D Teach button
- E Mounting sleeve (standard)
- F Threaded sleeve (3C.B series)

Electrical connection

Connection 1	
Type of connection	Connector
Function	Signal OUT Voltage supply

Part no.: 50137057 – PRK3C.T3/P-M8.3 – Polarized retro-reflective photoelectric

Connection 1	
Thread size	M8
Type	Male
Material	Metal
No. of pins	3 -pin
Encoding	

Pin	Pin assignment
1	V+
3	GND
4	OUT 1

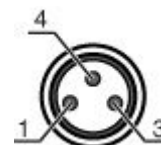

Diagrams

Typ. response behavior

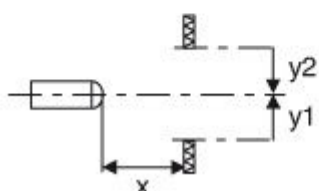
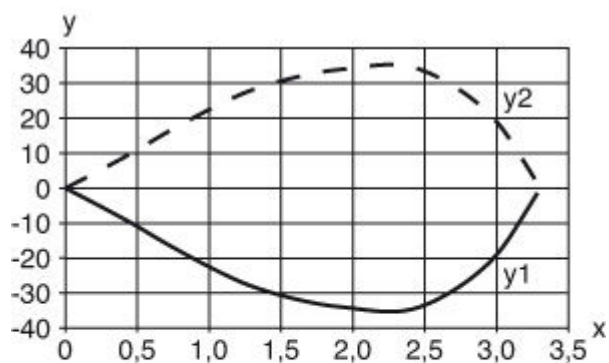

x Distance [m]
y Misalignment [mm]

Typ. function reserve

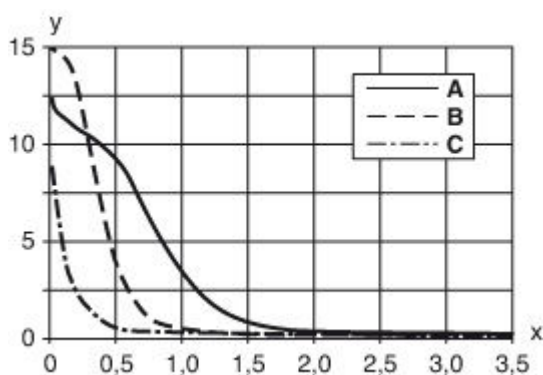

- x Distance [m]
- y Function reserve
- A TKS 40x60
- B TKS 20x40
- C Film REF 4-A-50x50



Operation and display

LEDs



LED	Display	Meaning
1	Green, continuous light	Operational readiness
2	Yellow, continuous light	Light path free
	Yellow, flashing	Light path free, no function reserve

Accessories











Connection technology - Connection cables

	Part no.	Designation	Article	Description
	50130842	KD U-M8-3A-P1-020	Connection cable	Connection 1: Connector, M8, Axial, Female, 3 -pin Connection 2: Open end Shielded: No Cable length: 2,000 mm Sheathing material: PUR
	50130844	KD U-M8-3A-P1-050	Connection cable	Connection 1: Connector, M8, Axial, Female, 3 -pin Connection 2: Open end Shielded: No Cable length: 5,000 mm Sheathing material: PUR





Connection technology - Interconnection cables

	Part no.	Designation	Article	Description
	50130886	KD U-M8-3A-P1-020-DP	Connection cable	Connection 1: Connector, M8, Axial, Female, 3 -pin Connector, LED: Yes, 1 Piece(s) Connection 2: Open end Shielded: No Cable length: 2,000 mm Sheathing material: PUR
	50130843	KD U-M8-3A-P1-030	Connection cable	Connection 1: Connector, M8, Axial, Female, 3 -pin Connection 2: Open end Shielded: No Cable length: 3,000 mm Sheathing material: PUR

Part no.: 50137057 – PRK3C.T3/P-M8.3 – Polarized retro-reflective photoelectric

	Part no.	Designation	Article	Description
	50130887	KD U-M8-3A-P1-050-DP	Connection cable	Connection 1: Connector, M8, Axial, Female, 3 -pin Connector, LED: Yes, 1 Piece(s) Connection 2: Open end Shielded: No Cable length: 5,000 mm Sheathing material: PUR
	50130845	KD U-M8-3A-P1-100	Connection cable	Connection 1: Connector, M8, Axial, Female, 3 -pin Connection 2: Open end Shielded: No Cable length: 10,000 mm Sheathing material: PUR
	50130888	KD U-M8-3A-P1-100-DP	Connection cable	Connection 1: Connector, M8, Axial, Female, 3 -pin Connector, LED: Yes, 1 Piece(s) Connection 2: Open end Shielded: No Cable length: 10,000 mm Sheathing material: PUR
	50130846	KD U-M8-3A-P1-150	Connection cable	Connection 1: Connector, M8, Axial, Female, 3 -pin Connection 2: Open end Shielded: No Cable length: 15,000 mm Sheathing material: PUR
	50130847	KD U-M8-3A-P1-200	Connection cable	Connection 1: Connector, M8, Axial, Female, 3 -pin Connection 2: Open end Shielded: No Cable length: 20,000 mm Sheathing material: PUR
	50130837	KD U-M8-3A-V1-020	Connection cable	Connection 1: Connector, M8, Axial, Female, 3 -pin Connection 2: Open end Shielded: No Cable length: 2,000 mm Sheathing material: PVC
	50130883	KD U-M8-3A-V1-020-DP	Connection cable	Connection 1: Connector, M8, Axial, Female, 3 -pin Connector, LED: Yes, 1 Piece(s) Connection 2: Open end Shielded: No Cable length: 2,000 mm Sheathing material: PVC
	50130838	KD U-M8-3A-V1-030	Connection cable	Connection 1: Connector, M8, Axial, Female, 3 -pin Connection 2: Open end Shielded: No Cable length: 3,000 mm Sheathing material: PVC
	50130832	KD U-M8-3A-V1-050	Connection cable	Connection 1: Connector, M8, Axial, Female, 3 -pin Connection 2: Open end Shielded: No Cable length: 5,000 mm Sheathing material: PVC
	50130884	KD U-M8-3A-V1-050-DP	Connection cable	Connection 1: Connector, M8, Axial, Female, 3 -pin Connector, LED: Yes, 1 Piece(s) Connection 2: Open end Shielded: No Cable length: 5,000 mm Sheathing material: PVC







Part no.: 50137057 – PRK3C.T3/P-M8.3 – Polarized retro-reflective photoelectric

	Part no.	Designation	Article	Description
	50130839	KD U-M8-3A-V1-100	Connection cable	Connection 1: Connector, M8, Axial, Female, 3 -pin Connection 2: Open end Shielded: No Cable length: 10,000 mm Sheathing material: PVC
	50130885	KD U-M8-3A-V1-100-DP	Connection cable	Connection 1: Connector, M8, Axial, Female, 3 -pin Connector, LED: Yes, 1 Piece(s) Connection 2: Open end Shielded: No Cable length: 10,000 mm Sheathing material: PVC
	50130840	KD U-M8-3A-V1-150	Connection cable	Connection 1: Connector, M8, Axial, Female, 3 -pin Connection 2: Open end Shielded: No Cable length: 15,000 mm Sheathing material: PVC
	50130841	KD U-M8-3A-V1-200	Connection cable	Connection 1: Connector, M8, Axial, Female, 3 -pin Connection 2: Open end Shielded: No Cable length: 20,000 mm Sheathing material: PVC
	50130865	KD U-M8-3W-P1-020	Connection cable	Connection 1: Connector, M8, Angled, Female, 3 -pin Connection 2: Open end Shielded: No Cable length: 2,000 mm Sheathing material: PUR
	50130893	KD U-M8-3W-P1-020-DP	Connection cable	Connection 1: Connector, M8, Angled, Female, 3 -pin Connector, LED: Yes, 1 Piece(s) Connection 2: Open end Shielded: No Cable length: 2,000 mm Sheathing material: PUR
	50130866	KD U-M8-3W-P1-030	Connection cable	Connection 1: Connector, M8, Angled, Female, 3 -pin Connection 2: Open end Shielded: No Cable length: 3,000 mm Sheathing material: PUR
	50130894	KD U-M8-3W-P1-030-DP	Connection cable	Connection 1: Connector, M8, Angled, Female, 3 -pin Connector, LED: Yes, 1 Piece(s) Connection 2: Open end Shielded: No Cable length: 3,000 mm Sheathing material: PUR
	50130867	KD U-M8-3W-P1-050	Connection cable	Connection 1: Connector, M8, Angled, Female, 3 -pin Connection 2: Open end Shielded: No Cable length: 5,000 mm Sheathing material: PUR
	50130895	KD U-M8-3W-P1-050-DP	Connection cable	Connection 1: Connector, M8, Angled, Female, 3 -pin Connector, LED: Yes, 1 Piece(s) Connection 2: Open end Shielded: No Cable length: 5,000 mm Sheathing material: PUR

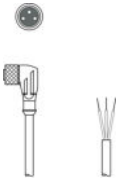
Part no.: 50137057 – PRK3C.T3/P-M8.3 – Polarized retro-reflective photoelectric

	Part no.	Designation	Article	Description
	50130868	KD U-M8-3W-P1-100	Connection cable	Connection 1: Connector, M8, Angled, Female, 3 -pin Connection 2: Open end Shielded: No Cable length: 10,000 mm Sheathing material: PUR
	50130896	KD U-M8-3W-P1-100-DP	Connection cable	Connection 1: Connector, M8, Angled, Female, 3 -pin Connector, LED: Yes, 1 Piece(s) Connection 2: Open end Shielded: No Cable length: 10,000 mm Sheathing material: PUR
	50130860	KD U-M8-3W-V1-020	Connection cable	Connection 1: Connector, M8, Angled, Female, 3 -pin Connection 2: Open end Shielded: No Cable length: 2,000 mm Sheathing material: PVC
	50130889	KD U-M8-3W-V1-020-DP	Connection cable	Connection 1: Connector, M8, Angled, Female, 3 -pin Connector, LED: Yes, 1 Piece(s) Connection 2: Open end Shielded: No Cable length: 2,000 mm Sheathing material: PVC
	50130861	KD U-M8-3W-V1-030	Connection cable	Connection 1: Connector, M8, Angled, Female, 3 -pin Connection 2: Open end Shielded: No Cable length: 3,000 mm Sheathing material: PVC
	50130890	KD U-M8-3W-V1-030-DP	Connection cable	Connection 1: Connector, M8, Angled, Female, 3 -pin Connector, LED: Yes, 1 Piece(s) Connection 2: Open end Shielded: No Cable length: 3,000 mm Sheathing material: PVC
	50130862	KD U-M8-3W-V1-050	Connection cable	Connection 1: Connector, M8, Angled, Female, 3 -pin Connection 2: Open end Shielded: No Cable length: 5,000 mm Sheathing material: PVC
	50130891	KD U-M8-3W-V1-050-DP	Connection cable	Connection 1: Connector, M8, Angled, Female, 3 -pin Connector, LED: Yes, 1 Piece(s) Connection 2: Open end Shielded: No Cable length: 5,000 mm Sheathing material: PVC
	50130863	KD U-M8-3W-V1-100	Connection cable	Connection 1: Connector, M8, Angled, Female, 3 -pin Connection 2: Open end Shielded: No Cable length: 10,000 mm Sheathing material: PVC
	50130892	KD U-M8-3W-V1-100-DP	Connection cable	Connection 1: Connector, M8, Angled, Female, 3 -pin Connector, LED: Yes, 1 Piece(s) Connection 2: Open end Shielded: No Cable length: 10,000 mm Sheathing material: PVC

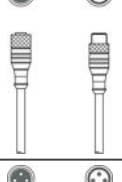
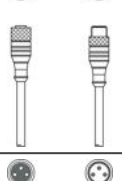
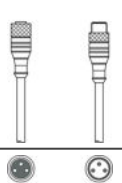
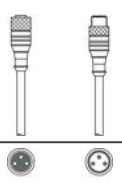
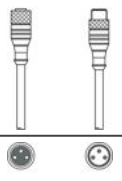
Part no.: 50137057 – PRK3C.T3/P-M8.3 – Polarized retro-reflective photoelectric

	Part no.	Designation	Article	Description
	50130864	KD U-M8-3W-V1-200	Connection cable	Connection 1: Connector, M8, Angled, Female, 3 -pin Connection 2: Open end Shielded: No Cable length: 20,000 mm Sheathing material: PVC
	50130929	KDS U-M8-3A-M12-3A-P1-010	Interconnection cable	Connection 1: Connector, M8, Axial, Female, 3 -pin Connection 2: Connector, M12, Axial, Male, A-coded, 3 -pin Shielded: No Cable length: 1,000 mm Sheathing material: PUR
	50130931	KDS U-M8-3A-M12-3A-P1-020	Interconnection cable	Connection 1: Connector, M8, Axial, Female, 3 -pin Connection 2: Connector, M12, Axial, Male, A-coded, 3 -pin Shielded: No Cable length: 2,000 mm Sheathing material: PUR
	50130932	KDS U-M8-3A-M12-3A-P1-050	Interconnection cable	Connection 1: Connector, M8, Axial, Female, 3 -pin Connection 2: Connector, M12, Axial, Male, A-coded, 3 -pin Shielded: No Cable length: 5,000 mm Sheathing material: PUR
	50130901	KDS U-M8-3A-M8-3A-P1-003	Interconnection cable	Connection 1: Connector, M8, Axial, Female, 3 -pin Connection 2: Connector, M8, Axial, Male, 3 -pin Shielded: No Cable length: 300 mm Sheathing material: PUR
	50130908	KDS U-M8-3A-M8-3A-P1-003-DP	Interconnection cable	Connection 1: Connector, M8, Axial, Female, 3 -pin Connection 2: Connector, M8, Axial, Male, 3 -pin Shielded: No Cable length: 300 mm Sheathing material: PUR
	50130902	KDS U-M8-3A-M8-3A-P1-006	Interconnection cable	Connection 1: Connector, M8, Axial, Female, 3 -pin Connection 2: Connector, M8, Axial, Male, 3 -pin Shielded: No Cable length: 600 mm Sheathing material: PUR
	50130909	KDS U-M8-3A-M8-3A-P1-006-DP	Interconnection cable	Connection 1: Connector, M8, Axial, Female, 3 -pin Connection 2: Connector, M8, Axial, Male, 3 -pin Shielded: No Cable length: 600 mm Sheathing material: PUR
	50130903	KDS U-M8-3A-M8-3A-P1-010	Interconnection cable	Connection 1: Connector, M8, Axial, Female, 3 -pin Connection 2: Connector, M8, Axial, Male, 3 -pin Shielded: No Cable length: 1,000 mm Sheathing material: PUR
	50130910	KDS U-M8-3A-M8-3A-P1-010-DP	Interconnection cable	Connection 1: Connector, M8, Axial, Female, 3 -pin Connection 2: Connector, M8, Axial, Male, 3 -pin Shielded: No Cable length: 1,000 mm Sheathing material: PUR

Part no.: 50137057 – PRK3C.T3/P-M8.3 – Polarized retro-reflective photoelectric





	Part no.	Designation	Article	Description
	50130904	KDS U-M8-3A-M8-3A-P1-015	Interconnection cable	Connection 1: Connector, M8, Axial, Female, 3 -pin Connection 2: Connector, M8, Axial, Male, 3 -pin Shielded: No Cable length: 1,500 mm Sheathing material: PUR
	50130911	KDS U-M8-3A-M8-3A-P1-015-DP	Interconnection cable	Connection 1: Connector, M8, Axial, Female, 3 -pin Connection 2: Connector, M8, Axial, Male, 3 -pin Shielded: No Cable length: 1,500 mm Sheathing material: PUR
	50130905	KDS U-M8-3A-M8-3A-P1-020	Interconnection cable	Connection 1: Connector, M8, Axial, Female, 3 -pin Connection 2: Connector, M8, Axial, Male, 3 -pin Shielded: No Cable length: 2,000 mm Sheathing material: PUR
	50130912	KDS U-M8-3A-M8-3A-P1-020-DP	Interconnection cable	Connection 1: Connector, M8, Axial, Female, 3 -pin Connection 2: Connector, M8, Axial, Male, 3 -pin Shielded: No Cable length: 2,000 mm Sheathing material: PUR
	50130906	KDS U-M8-3A-M8-3A-P1-030	Interconnection cable	Connection 1: Connector, M8, Axial, Female, 3 -pin Connection 2: Connector, M8, Axial, Male, 3 -pin Shielded: No Cable length: 3,000 mm Sheathing material: PUR
	50130907	KDS U-M8-3A-M8-3A-P1-050	Interconnection cable	Connection 1: Connector, M8, Axial, Female, 3 -pin Connection 2: Connector, M8, Axial, Male, 3 -pin Shielded: No Cable length: 5,000 mm Sheathing material: PUR
	50130897	KDS U-M8-3A-M8-3A-V1-003	Interconnection cable	Connection 1: Connector, M8, Axial, Female, 3 -pin Connection 2: Connector, M8, Axial, Male, 3 -pin Shielded: No Cable length: 300 mm Sheathing material: PVC
	50130898	KDS U-M8-3A-M8-3A-V1-006	Interconnection cable	Connection 1: Connector, M8, Axial, Female, 3 -pin Connection 2: Connector, M8, Axial, Male, 3 -pin Shielded: No Cable length: 600 mm Sheathing material: PVC
	50130899	KDS U-M8-3A-M8-3A-V1-010	Interconnection cable	Connection 1: Connector, M8, Axial, Female, 3 -pin Connection 2: Connector, M8, Axial, Male, 3 -pin Shielded: No Cable length: 1,000 mm Sheathing material: PVC
	50130900	KDS U-M8-3A-M8-3A-V1-020	Interconnection cable	Connection 1: Connector, M8, Axial, Female, 3 -pin Connection 2: Connector, M8, Axial, Male, 3 -pin Shielded: No Cable length: 2,000 mm Sheathing material: PVC

Part no.: 50137057 – PRK3C.T3/P-M8.3 – Polarized retro-reflective photoelectric





	Part no.	Designation	Article	Description
	50130917	KDS U-M8-3W-M8-3A-P1-003	Interconnection cable	Connection 1: Connector, M8, Angled, Female, 3 -pin Connection 2: Connector, M8, Axial, Male, 3 -pin Shielded: No Cable length: 300 mm Sheathing material: PUR
	50130921	KDS U-M8-3W-M8-3A-P1-003-DP	Interconnection cable	Connection 1: Connector, M8, Angled, Female, 3 -pin Connection 2: Connector, M8, Axial, Male, 3 -pin Shielded: No Cable length: 300 mm Sheathing material: PUR
	50130918	KDS U-M8-3W-M8-3A-P1-006	Interconnection cable	Connection 1: Connector, M8, Angled, Female, 3 -pin Connection 2: Connector, M8, Axial, Male, 3 -pin Shielded: No Cable length: 600 mm Sheathing material: PUR
	50130922	KDS U-M8-3W-M8-3A-P1-006-DP	Interconnection cable	Connection 1: Connector, M8, Angled, Female, 3 -pin Connection 2: Connector, M8, Axial, Male, 3 -pin Shielded: No Cable length: 600 mm Sheathing material: PUR
	50130919	KDS U-M8-3W-M8-3A-P1-010	Interconnection cable	Connection 1: Connector, M8, Angled, Female, 3 -pin Connection 2: Connector, M8, Axial, Male, 3 -pin Shielded: No Cable length: 1,000 mm Sheathing material: PUR
	50130923	KDS U-M8-3W-M8-3A-P1-010-DP	Interconnection cable	Connection 1: Connector, M8, Angled, Female, 3 -pin Connection 2: Connector, M8, Axial, Male, 3 -pin Shielded: No Cable length: 1,000 mm Sheathing material: PUR
	50130925	KDS U-M8-3W-M8-3A-P1-015-DP	Interconnection cable	Connection 1: Connector, M8, Angled, Female, 3 -pin Connection 2: Connector, M8, Axial, Male, 3 -pin Shielded: No Cable length: 1,500 mm Sheathing material: PUR
	50130920	KDS U-M8-3W-M8-3A-P1-020	Interconnection cable	Connection 1: Connector, M8, Angled, Female, 3 -pin Connection 2: Connector, M8, Axial, Male, 3 -pin Shielded: No Cable length: 2,000 mm Sheathing material: PUR
	50130926	KDS U-M8-3W-M8-3A-P1-020-DP	Interconnection cable	Connection 1: Connector, M8, Angled, Female, 3 -pin Connection 2: Connector, M8, Axial, Male, 3 -pin Shielded: No Cable length: 2,000 mm Sheathing material: PUR

Part no.: 50137057 – PRK3C.T3/P-M8.3 – Polarized retro-reflective photoelectric

Mounting technology - Mounting brackets





	Part no.	Designation	Article	Description
	50118542	BT 200M.5	Mounting bracket	Design of mounting device: Angle, L-shape Mounting bracket, at system: Through-hole mounting Mounting bracket, at device: Screw type Type of mounting device: Adjustable Material: Stainless steel
	50124651	BT 205M	Mounting device set	Contains: 10x Design of mounting device: Angle, L-shape Mounting bracket, at system: Through-hole mounting Mounting bracket, at device: Screw type Type of mounting device: Rigid Material: Metal
	50060511	BT 3	Mounting device	Design of mounting device: Angle, L-shape Mounting bracket, at system: Through-hole mounting Mounting bracket, at device: Screw type Type of mounting device: Rigid Material: Metal
	50105585	BT 3.1	Mounting strap set	Contains: 10x Design of mounting device: Retaining clip Mounting bracket, at system: Through-hole mounting Mounting bracket, at device: Screw type Type of mounting device: Rigid Material: Metal
	50105546	BT 3B	Mounting device	Design of mounting device: Angle, L-shape Mounting bracket, at system: Through-hole mounting Mounting bracket, at device: Screw type Type of mounting device: Rigid Material: Metal

Mounting technology - Rod mounts

	Part no.	Designation	Article	Description
	50117256	BTU 200M-D10	Mounting system	Contains: 2x M3 x 18 screw, 2x position washers Design of mounting device: Mounting system Mounting bracket, at system: For 10 mm rod, Sheet-metal mounting Mounting bracket, at device: Screw type Type of mounting device: Clampable, Adjustable, Turning, 360° Material: Metal
	50117255	BTU 200M-D12	Mounting system	Contains: 2x M3 x 18 screw, 2x position washers Design of mounting device: Mounting system Mounting bracket, at system: For 12 mm rod, Sheet-metal mounting Mounting bracket, at device: Screw type Type of mounting device: Clampable, Adjustable, Turning, 360° Material: Metal
	50117254	BTU 200M-D14	Mounting system	Contains: 2x M3 x 18 screw, 2x position washers Design of mounting device: Mounting system Mounting bracket, at system: For 14 mm rod, Sheet-metal mounting Mounting bracket, at device: Screw type Type of mounting device: Clampable, Adjustable, Turning, 360° Material: Metal
	50120426	BTU 200M.5-D12	Mounting system	Contains: 2x M3 x 18 screw, 2x M3 mounting nut, 2x position washers Design of mounting device: Mounting system Mounting bracket, at system: For 12 mm rod Mounting bracket, at device: Screw type Type of mounting device: Turning, 360°, Clampable, Adjustable Material: Stainless steel

Part no.: 50137057 – PRK3C.T3/P-M8.3 – Polarized retro-reflective photoelectric

Standard reflectors

	Part no.	Designation	Article	Description
	50134985	MTKS 20x30.1	Reflector	Design: Rectangular Reflective surface: 18.5 mm x 28.5 mm Triple reflector size: 1 mm Material: Plastic Base material: Plastic Chemical designation of the material: PMMA Fastening: Through-hole mounting, Adhesive
	50003192	TK 100x100	Reflector	Design: Rectangular Reflective surface: 96 mm x 96 mm Triple reflector size: 4 mm Material: Plastic Base material: Plastic Chemical designation of the material: PMMA8N Fastening: Adhesive
	50022816	TKS 100X100	Reflector	Design: Rectangular Reflective surface: 96 mm x 96 mm Triple reflector size: 4 mm Material: Plastic Base material: Plastic Chemical designation of the material: PMMA8N Fastening: Through-hole mounting, Adhesive
	50081283	TKS 20X40	Reflector	Design: Rectangular Reflective surface: 16 mm x 38 mm Triple reflector size: 2.3 mm Material: Plastic Base material: Plastic Chemical designation of the material: PMMA8N Fastening: Through-hole mounting, Adhesive
	50040820	TKS 40X60	Reflector	Design: Rectangular Reflective surface: 37 mm x 56 mm Triple reflector size: 4 mm Material: Plastic Base material: Plastic Chemical designation of the material: PMMA8N Fastening: Through-hole mounting, Adhesive

Micro-triad-type reflectors

	Part no.	Designation	Article	Description
	50117583	MTKS 50x50.1	Reflector	Design: Rectangular Reflective surface: 50 mm x 50 mm Material: Plastic Base material: Plastic Chemical designation of the material: PMMA8N Fastening: Through-hole mounting, Adhesive

Reflective tapes for laser and clear-glass applications

	Part no.	Designation	Article	Description
	50110192	REF 6-A-50x50	Reflective tape	Design: Rectangular Reflective surface: 50 mm x 50 mm Material: Plastic Chemical designation of the material: PMMA Fastening: Self-adhesive

Notes

Observe intended use!

- This product is not a safety sensor and is not intended as personnel protection.
- The product may only be put into operation by competent persons.
- Only use the product in accordance with its intended use.

For UL applications:

- For UL applications, use is only permitted in Class 2 circuits in accordance with the NEC (National Electric Code).
- These proximity switches shall be used with UL Listed Cable assemblies rated 30V, 0.5A min, in the field installation, or equivalent (categories: CYJV/CYJV7 or PVVA/PVVA7)

- Light source: Average life expectancy 100,000 h at an ambient temperature of 25 °C
- Response time: For short decay times, an ohmic load of approx. 5 kOhm is recommended
- Sum of the output currents for both outputs, 50 mA for ambient temperatures > 40 °C
- The light spot may not exceed the reflector.
- Use of MTK(S) or REF 6-A- reflective tape is preferred.
- For REF 6-A reflective tape, the sensor's side edge must be aligned parallel to the side edge of the reflective tape.