

PRK 3B Standard Retro-reflective photoelectric sensors with polarisation filter

en 09-2014/05 50105365-01



0.02 ... 6m



- Polarized retro-reflective photoelectric sensor with visible red light
- High performance reserve
- Small and compact construction with robust plastic housing, protection class IP 67 for industrial application
- Fast alignment through *brightVision*®
- A²LS- Active Ambient Light Suppression
- Push-pull switching outputs
- High switching frequency for detection of fast events
- Warning output for increased availability

We reserve the right to make changes • DS_PRK3BStandard_en_50105365-01.fm



Accessories:

(available separately)

- Mounting systems (BT 3...)
- Cable with M8 or M12 connector (K-D ...)
- Reflectors
- Reflective tapes

Dimensioned drawing

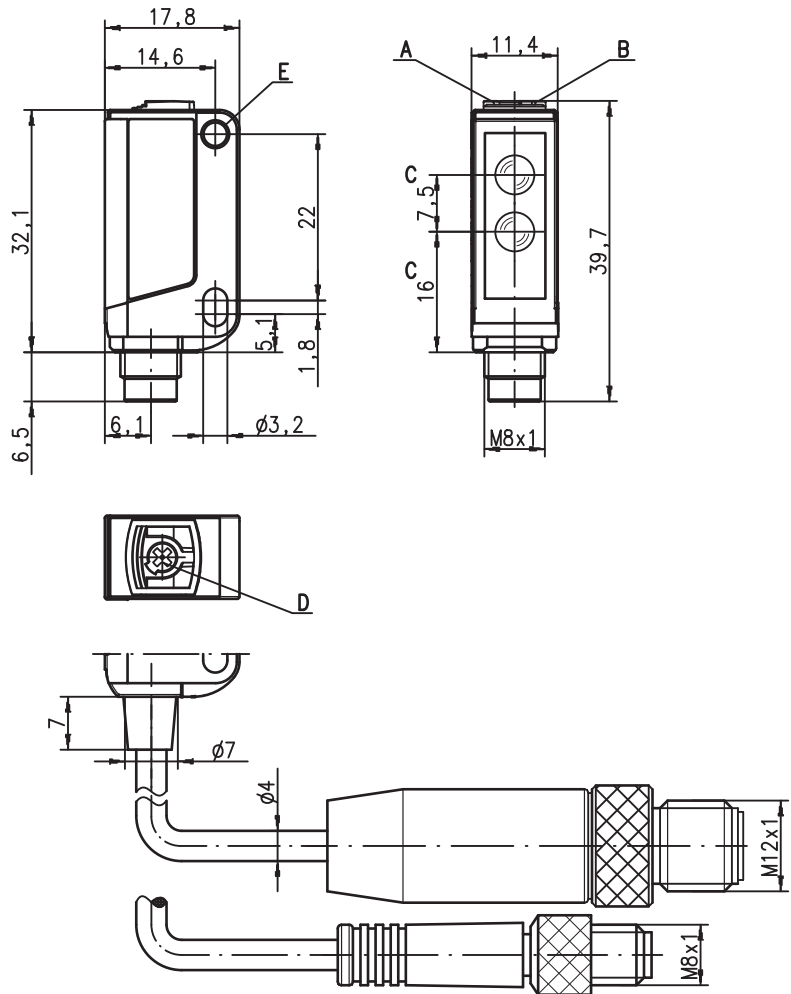

- A Green indicator diode
- B Yellow indicator diode
- C Optical axis
- D Potentiometer for operating range adjustment (PRK 3B/66.1... only)
- E Attachment sleeve

Electrical connection

Plug connection, 4-pin

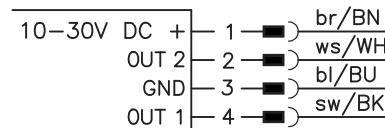

Cable, 4-wire

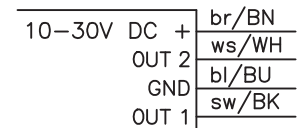

Plug connection, 3-pin

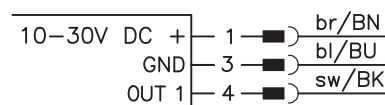

Specifications

Optical data

Typ. op. range limit (TK(S) 100x100) ¹⁾ 0.02 ... 6m
 Operating range ²⁾ see tables
 Light source ³⁾ LED (modulated light)
 Wavelength 620nm (visible red light, polarized)

Timing

Switching frequency 200Hz ... 1500Hz (see order guide)
 Response time 2.5 ms ... 0.5ms
 Delay before start-up ≤ 300ms

Electrical data

Operating voltage U_B ⁴⁾ 10 ... 30VDC (incl. residual ripple)
 Residual ripple ≤ 15% of U_B
 Open-circuit current ≤ 14mA
 Switching output .../66 ⁵⁾ 2 push-pull switching outputs
 pin 2: PNP dark switching, NPN light switching
 pin 4: PNP light switching, NPN dark switching
 .../6 ⁵⁾ 1 push-pull switching output
 pin 4: PNP light switching, NPN dark switching
 .../6D ⁵⁾ 1 push-pull switching output
 pin 4: PNP dark switching, NPN light switching
 .../44D 2 PNP switching outputs, complementary
 .../4 1 PNP switching output light switching, 1 warning output
 .../4D 1 PNP switching output dark switching, pin 2: not connected ⁶⁾
 .../22D 2 NPN switching outputs, complementary
 light/dark switching
 Signal voltage high/low $\geq (U_B - 2V) \leq 2V$
 Output current max. 100mA
 Operating range permanently set or adjustable, see order guide

Indicators

Green LED ready
 Yellow LED light path free
 Yellow LED, flashing light path free, no performance reserve

Mechanical data

Housing plastic (PC-ABS); 1 attachment sleeve, nickel-plated steel
 Optics cover plastic (PMMA)
 Weight with connector: 10g
 with 200mm cable and connector: 20g
 with 2m cable: 50g
 2m cable (cross section 4x0.20mm²),
 connector M8 metal,
 0.2m cable with connector M8 or M12

Connection type

Environmental data

Ambient temp. (operation/storage) -30°C ... +55°C/-30°C ... +70°C
 Protective circuit ⁷⁾ 2, 3
 VDE safety class III
 Protection class IP 67
 Light source free group (in accordance with EN 62471)
 Standards applied IEC 60947-5-2
 Certifications UL 508, C22.2 No.14-13 ^{4) 8)}

Options

Warning output autoControl warn PNP transistor, counting principle
 Signal voltage high/low $\geq (U_B - 2V) \leq 2V$
 Output current max. 100mA

- 1) Typ. operating range limit: max. attainable range without performance reserve
- 2) Operating range: recommended range with performance reserve
- 3) Average life expectancy 100,000h at an ambient temperature of 25°C
- 4) For UL applications: for use in class 2 circuits according to NEC only
- 5) The push-pull switching outputs must not be connected in parallel
- 6) Pin 2: unassigned, hence especially suitable for the connection to AS-interface I/O coupling modules
- 7) 2=polarity reversal protection, 3=short-circuit protection for all transistor outputs
- 8) These proximity switches shall be used with UL Listed Cable assemblies rated 30V, 0.5A min, in the field installation, or equivalent (categories: CYJV/CYJV7 or PVVA/PVVA7)

Remarks

Adapter plate: BT 3.2 (part no. 50103844) for alternate mounting on 25.4mm hole spacing (Omron E3Z, Sick W100...)

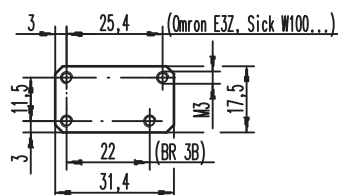

Tables

Reflectors			Operating range	
1	TK(S)	100x100	0.02 ... 5.0m	
2	TK	40x60	0.02 ... 3.0m	
3	TK	20x40	0.02 ... 1.5m	
4	Tape 4	50x50	0.1 ... 1.2m	

1	0,02			5	6
2	0,02		3	3,6	
3	0,02	1,5		2	
4	0,1	1,2		1,6	

□ Operating range [m]
 ▒ Typ. operating range limit [m]

TK ... = adhesive
 TKS ... = screw type

Diagrams

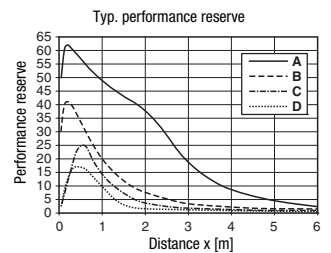
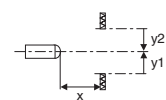
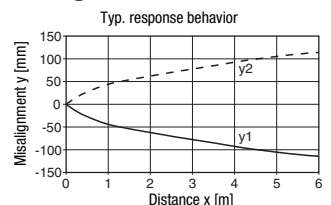

- A TK 100x100
- B TKS 40x60
- C TKS 20x40
- D Tape 4: 50x50

Remarks

Mounting system:









- ① = BT 3 (part no. 50060511)
- ②+③ = BT 3.1 ¹⁾ (part no. 50105585)
- ①+②+③ = BT 3B (part no. 50105546)

1) Packaging unit: PU = 10 pcs.

PRK 3B Standard Retro-reflective photoelectric sensors with polarisation filter

Order guide

Selection table				Order code →																				
Equipment ↓				PRK 3B/66	PRK 3B/66-S8	PRK 3B/66, 200-S8	PRK 3B/66, 200-S12	PRK 3B/66.1	PRK 3B/66.1-S8	PRK 3B/66.1, 200-S8	PRK 3B/66.1, 200-S12	PRK 3B/44D.01	PRK 3B/22D.01	PRK 3B/4D-S8	IPRK 3B/4-S8	PRK 3B/6-S8.3	PRK 3B/6, 200-S8.3	PRK 3B/6D-S8.3	PRK 3B/6D, 200-S8.3	PRK 3B/6.01-S8	PRK 3B/44D.01, 160-AMP	PRK 3B/22D.01, 160-AMP	PRK 3B/22D.01, 5000	
				Part No. 50104693	Part No. 50104694	Part No. 50104695	Part No. 50104696	on request	Part No. 50106078	on request	on request	Part No. 50106513	Part No. 50106514	on request	on request	Part No. 50109581	on request	on request	on request	Part No. 50106015	Part No. 50109490	on request	Part No. 50108309	
Output 1 (OUT 1)	push-pull switching output		light switching	<input type="radio"/>	●	●	●	●	●	●	●				●	●				●				
			dark switching	<input type="radio"/>																				
	PNP transistor output		light switching	<input type="radio"/>									●											
			dark switching	<input type="radio"/>											●								●	
	NPN transistor output		light switching	<input type="radio"/>										●										●
			dark switching	<input type="radio"/>												●								
Output 2 (OUT 2)	push-pull switching output		light switching	<input type="radio"/>	●	●	●	●	●	●	●													
			dark switching	<input type="radio"/>																				
	PNP transistor output		light switching	<input type="radio"/>									●											
			dark switching	<input type="radio"/>											●								●	
	NPN transistor output		light switching	<input type="radio"/>										●										●
			dark switching	<input type="radio"/>												●								
warning output (PNP transistor)		light switching	<input type="radio"/>											●										
Connection	cable 2000 mm	4-wire		●				●				●	●										●	
	cable 5000 mm	4-wire																						
	M8 connector, metal	3-pin								●						●		●						
	M8 connector, metal	4-pin			●					●				●	●									
	M8 connector, metal, snap-on	4-pin																		●				
	200 mm cable with M8 connector	3-pin															●		●					
	200 mm cable with M8 connector	4-pin				●					●													
	200 mm cable with M12 connector	4-pin					●				●													
	cable 160 mm with AMP connector	4-pin																			●	●		
	pin 2: not assigned, suitable for connecting to AS-i coupling module														●						●			
Configuration	permanently set to maximum range			●	●	●	●					●	●	●	●	●	●	●	●	●	●	●	●	
	potentiometer, rotational angle approx. 250°							●	●	●	●													
Switching frequency	200Hz																				●			
	1000Hz			●	●	●	●	●	●	●	●			●	●	●	●	●	●					
	1500Hz											●	●								●	●	●	

● **Approved purpose:**

This product may only be used by qualified personnel and must only be used for the approved purpose. This sensor is not a safety sensor and is not to be used for the protection of persons.

