

PRK 328

Retro-reflective photoelectric sensors for semi-transparent media

en 04-2015/09 50123802

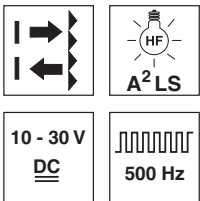

0.02 ... 6.0m
0.02 ... 5.0m
(with 90° angular optics)

- Polarized retro-reflective photoelectric sensor using visible red light
- Easy adjustment via teach button
- Axial and 90° light beam gate for flexible integration
- Active suppression of extraneous light A²LS
- Fast alignment through *brightVision*®
- Simple fine adjustment via *omni-mount*
- Sturdy plastic housing with stainless steel threaded sleeve with cylindrical M18x1 design
- Complementary outputs for light/dark switching

We reserve the right to make changes • DS_PRK328W3_en_50123802.fm

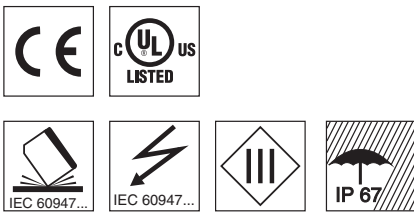

Accessories:

(available separately)

- Mounting systems (BT D18M.5, BT 318...)
- M12 connectors (KD ...)
- Ready-made cables (K-D ...)
- Reflectors
- Reflective tape

Dimensioned drawing

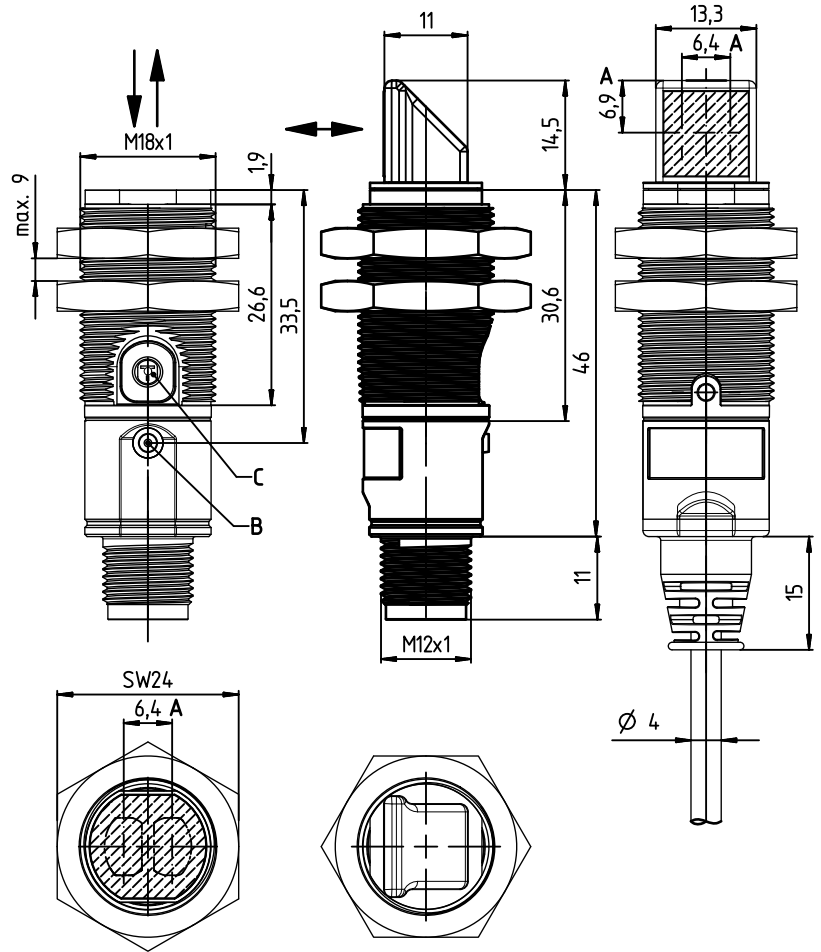

- A Optical axes
- B Indicator diode
- C Teach button

Electrical connection

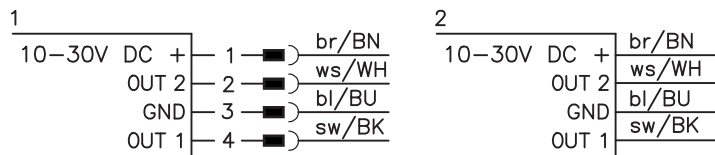

Specifications

Optical data

Typ. op. range limit (TK(S) 100x100) ¹⁾
 Operating range ²⁾
 Light source
 Wavelength

axial optics: 0.02 ... 6.0 m 90° optics 0.02 ... 5.0 m
 see tables
 LED (modulated light)
 620nm (visible red light, polarized)

Timing

Switching frequency 500Hz
 Response time 1ms
 Delay before start-up ≤ 300ms

Electrical data

Operating voltage U_B ³⁾ 10 ... 30VDC
 Residual ripple ≤ 15% of U_B
 Open-circuit current ≤ 20mA
 Switching output .../4P... 2 PNP transistor outputs
 .../2N... 2 NPN transistor outputs
 pin 2: PNP dark switching, pin 4: PNP light switching
 pin 2: NPN dark switching, pin 4: NPN light switching
 Signal voltage high/low $\geq (U_B - 2.5V) / \leq 2.5V$
 Output current max. 100mA ⁴⁾

Indicators

Green LED ready
 Yellow LED light path free
 Yellow LED, flashing light path free, no performance reserve

Mechanical data

Housing plastic with stainless steel threaded sleeve
 Optics cover plastic
 Weight 30g with M12 connector
 80g with 2m cable
 Connection type M12 connector, 4-pin
 cable 2m, 4x0.20mm²

Environmental data

Ambient temp. (operation/storage) -40°C ... +60°C / -40°C ... +70°C
 Protective circuit ⁵⁾ 2, 3
 VDE safety class III
 Protection class IP 67
 Light source exempt group (in acc. with EN 62471)
 Standards applied IEC 60947-5-2
 Certifications UL 508, C22.2 No.14-13 ³⁾ ⁶⁾

- 1) Typ. operating range limit: max. attainable range without performance reserve
- 2) Operating range: recommended range with performance reserve
- 3) For UL applications: for use in class 2 circuits according to NEC only
- 4) Sum of the output currents for both outputs, 50mA when ambient temperatures > 40°C
- 5) 2=polarity reversal protection, 3=short circuit protection for all outputs
- 6) These proximity switches shall be used with UL Listed Cable assemblies rated 30V, 0.5A min, in the field installation, or equivalent (categories: CYJV/CYJV7 or PVVA/PVVA7)

Remarks

Operate in accordance with intended use!

- ⚠ This product is not a safety sensor and is not intended as personnel protection.
- ⚠ The product may only be put into operation by competent persons.
- ⚠ Only use the product in accordance with the intended use.

Tables

Axial optics:

Reflectors	Operating range
1 TK(S) 100x100	0.02 ... 4.5m
2 TKS 40x60	0.02 ... 3.0m
3 TKS 82.2	0.05 ... 3.6m
4 TKS 30x50	0.03 ... 1.9m
5 TKS 20x40	0.04 ... 1.6m
6 Tape 4 50x50	0.08 ... 1.4m

1	0.02	4.5	6.0
2	0.02	3.0	4.0
3	0.05	3.6	4.5
4	0.03	1.9	2.5
5	0.04	1.6	2.2
6	0.08	1.4	2.0

90° optics:

Reflectors	Operating range
1 TK(S) 100x100	0.02 ... 4.0m
2 TKS 40x60	0.02 ... 2.6m
3 TKS 82.2	0.05 ... 3.3m
4 TKS 30x50	0.05 ... 1.6m
5 TKS 20x40	0.04 ... 1.5m
6 Tape 4 50x50	0.10 ... 1.3m

1	0.02	4.0	5.0
2	0.02	2.6	3.5
3	0.05	3.3	4.0
4	0.05	1.6	2.0
5	0.04	1.5	2.0
6	0.10	1.3	1.8

□ Operating range [m]
 □ Typ. operating range limit [m]

Diagrams

Typ. response behavior (TK 100x100)

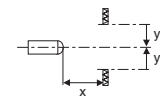
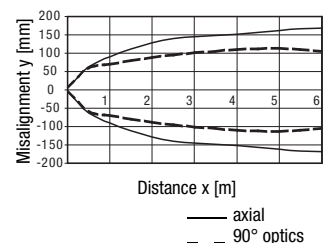

Typ. performance reserve (axial model)

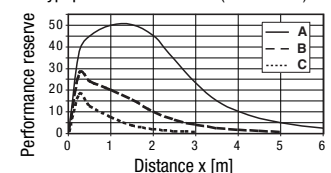

- A TKS 100x100
- B TKS 40x60
- C TKS 20x40

PRK 328 Retro-reflective photoelectric sensors for semi-transparent media

Order guide

The sensors listed here are preferred types; current information at www.leuze.com.

		Designation	Part no.
Sensors with axial optics			
With M12 connector	Pin 4: PNP light switching, pin 2: PNP dark switching	PRK328.3/4P-M12	50122695
	Pin 4: NPN light switching, pin 2: NPN dark switching	PRK328.3/2N-M12	50122697
With cable, 2m	Pin 4: PNP light switching, pin 2: PNP dark switching	PRK328.3/4P	50122696
	Pin 4: NPN light switching, pin 2: NPN dark switching	PRK328.3/2N	50122698
Sensors with 90° angular optics			
With M12 connector	Pin 4: PNP light switching, pin 2: PNP dark switching	PRK328.W3/4P-M12	50122689
	Pin 4: NPN light switching, pin 2: NPN dark switching	PRK328.W3/2N-M12	50122691
With cable, 2m	Pin 4: PNP light switching, pin 2: PNP dark switching	PRK328.W3/4P	50122690
	Pin 4: NPN light switching, pin 2: NPN dark switching	PRK328.W3/2N	50122694
Accessories for optimum fastening			
Mounting system <i>omni-mount</i>		BT318B-OM	50121904
Mounting bracket for standard mounting		BT D18M.5	50113548
Mounting bracket for <i>omni-mount</i>		BT D21M	50117257

Part number code

PRK328.W3/4P-M12

Operating principle	
PRK	Polarized retro-reflective photoelectric sensor
Series	
328	328 Series
Optics design	
.3	Axial optics, Teach-in via teach button
.W3	90° angular optics, Teach-in via teach button
Switching output/function /OUT1/OUT2 (OUT1 = Pin 4, OUT2 = Pin 2)	
4	PNP transistor output, light switching
P	PNP transistor output, dark switching
2	NPN transistor output, light switching
N	NPN transistor output, dark switching
X	Pin not used
Combinations of functions are possible via two-digit code!	
Electrical connection	
N/A	Cable, standard length 2000mm
-M12	M12 connector

Sensor adjustment (teach) via teach button



- **The sensor is factory-adjusted for maximum operating range.**
Recommendation: teach only if the desired objects are not reliably detected.
- **Prior to teaching: Clear the light path to the reflector!**
The device setting is stored in a fail-safe way. A reconfiguration following voltage interruption or switch-off is thus not required.

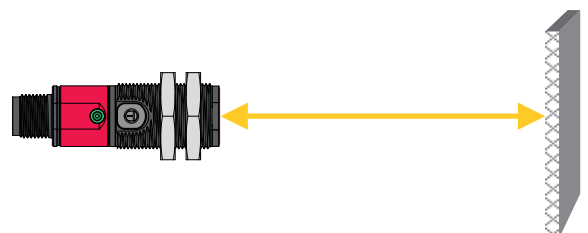

Standard teaching for average sensor sensitivity

- Press teach button until the **yellow** LED flashes.
- Release teach button.
- Ready.



After the standard teaching, the sensor switches when half of the light beam is covered by the object.

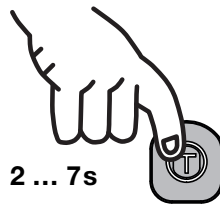

Teaching for increased sensor sensitivity

- Press teach button until green and yellow LEDs flash **alternately**.
- Release teach button.
- Ready.



After the teaching for increased sensor sensitivity, the sensor switches when about 25 % of the light beam are covered by the object.

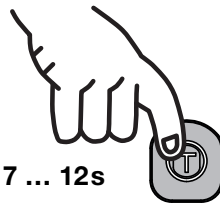

Teaching for maximum operating range (factory setting at delivery)

- **Prior to teaching:**
Cover the light path to the reflector!
- Procedure as for standard teaching.

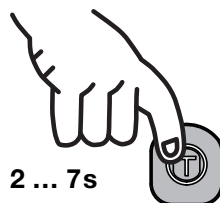
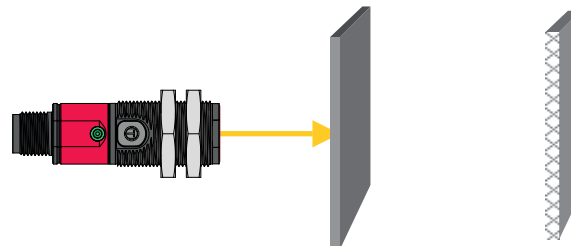

Adjusting the switching behavior of the switching output – light/dark switching

This function permits inversion of the sensors' switching logic.

- Press teach button until the **green** LED flashes.
- Release teach button.
- The LED then displays the changed switching logic for 2s:

YELLOW Continuous light = switching outputs **light switching** (in the case of complementary sensors, Q1 (pin 4) light switching, Q2 (pin 2) dark switching), this means output active when object is detected.

GREEN Flashing light = switching outputs **dark switching** (in the case of complementary sensors, Q1 (pin 4) dark switching, Q2 (pin 2) light switching), this means output inactive when object is detected.

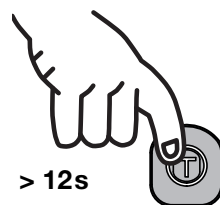

2s YELLOW = light switching

or



flashes GREEN for 2s = dark switching

- Ready.