

**PRK 28** Retro-reflective photoelectric sensors for semi-transparent media

en 01-2015/11 50130115

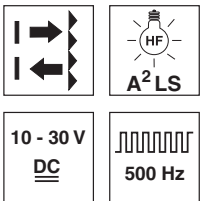

0.02 ... 6.0m

- Polarized retro-reflective photoelectric sensor using visible red light
- Easy adjustment via teach button
- Active suppression of extraneous light A²LS
- Fast alignment through *brightVision*®
- Universal option for M18 hole mounting at the front and connector side
- Easy through-hole assembly with anti-rotation protection for mounting nuts on the housing
- Full control through green and yellow indicator LEDs
- Robust, glass fiber reinforced plastic housing acc. to IP 67 for industrial application
- Complementary outputs for light/dark switching

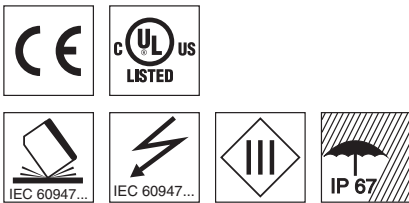

**Accessories:**

- (available separately)
- Mounting systems (BTU 200 ..., BT 200..., BTU D18...)
  - M12 connectors (KD ...)
  - Ready-made cables (K-D ...)
  - Reflectors
  - Reflective tape

**Dimensioned drawing**

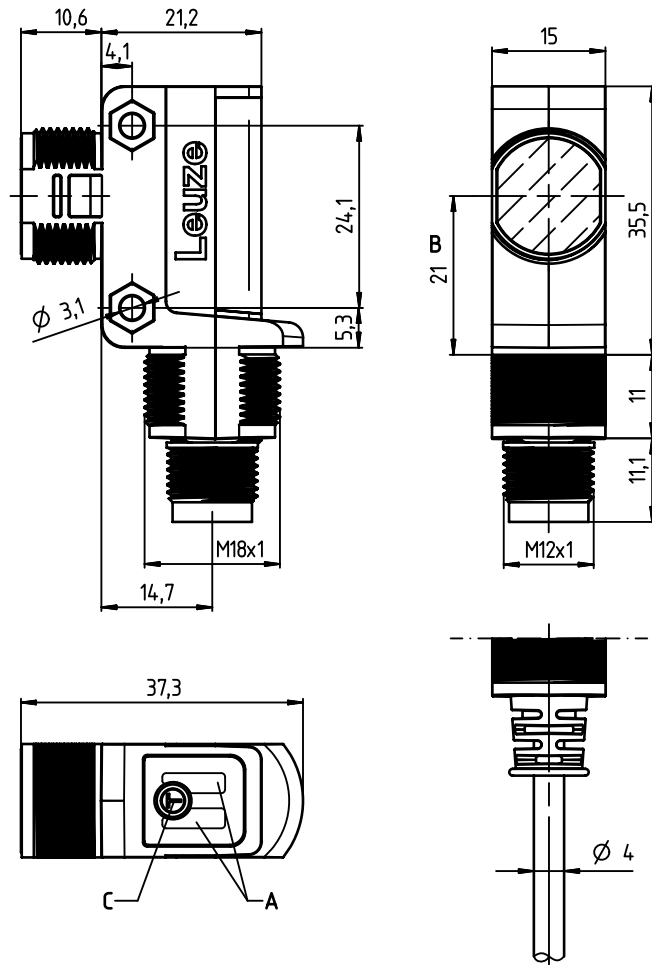

- A** Indicator diodes
- B** Optical axis
- C** Teach button

**Electrical connection**

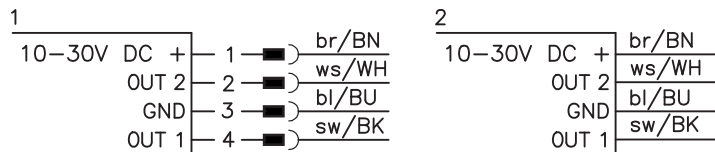

Änderungen vorbehalten • DS\_PRK28\_3\_en\_50130115.fm

## Specifications

### Optical data

Typ. op. range limit (TK(S) 100x100) <sup>1)</sup>	0.02 ... 6.0m
Operating range <sup>2)</sup>	see tables
Light source	LED (modulated light)
Wavelength	620nm (visible red light, polarised)

### Timing

Switching frequency	500Hz
Response time	1ms
Delay before start-up	≤ 300ms

### Electrical data

Operating voltage $U_B$ <sup>3)</sup>	10 ... 30VDC
Residual ripple	≤ 15% of $U_B$
Open-circuit current	≤ 20mA
Switching output	.../4P... 2 PNP transistor outputs pin 2: PNP dark switching, pin 4: PNP light switching 2 NPN transistor outputs pin 2: NPN dark switching, pin 4: NPN light switching
	.../2N... $\geq (U_B - 2.5V) \leq 2.5V$ max. 100mA <sup>4)</sup>
Signal voltage high/low	
Output current	

### Indicators

Green LED	ready
Yellow LED	light path free
Yellow LED, flashing	light path free, no performance reserve

### Mechanical data

Housing	plastic, glass fiber reinforced
Optics cover	plastic
Weight	25g with M12 connector 45g with 200mm cable and M12 connector 75g with 2m cable
Connection type	M12 connector, 4-pin cable 200mm with M12 connector, 4-pin cable 2m, 4x0.20mm <sup>2</sup>

### Environmental data

Ambient temp. (operation/storage)	-40°C ... +60°C/-40°C ... +70°C
Protective circuit <sup>5)</sup>	2, 3
VDE safety class	III
Protection class	IP 67
Light source	free group (in acc. with EN 62471)
Standards applied	IEC 60947-5-2
Certifications	UL 508, C22.2 No.14-13 <sup>3) 6)</sup>

- 1) Typ. operating range limit: max. attainable range without performance reserve
- 2) Operating range: recommended range with performance reserve
- 3) For UL applications: for use in class 2 circuits according to NEC only
- 4) Sum of the output currents for both outputs, 50mA when ambient temperatures > 40°C
- 5) 2=polarity reversal protection, 3=short circuit protection for all outputs
- 6) These proximity switches shall be used with UL Listed Cable assemblies rated 30V, 0.5A min, in the field installation, or equivalent (categories: CYJV/CYJV7 or PVVA/PVVA7)

## Tables

Reflectors	Operating range
1 TK(S) 100x100	0.02 ... 4.5m
2 TKS 40x60	0.02 ... 3.0m
3 TKS 82.2	0.05 ... 3.6m
4 TKS 30x50	0.03 ... 1.9m
5 TKS 20x40	0.04 ... 1.6m
6 Tape 4 50x50	0.08 ... 1.4m

1	0.02	4.5	6.0
2	0.02	3.0	4.0
3	0.05	3.6	4.5
4	0.03	1.9	2.5
5	0.04	1.6	2.2
6	0.08	1.4	2.0

□ Operating range [m]  
 □ Typ. operating range limit [m]

## Diagrams

Typ. response behavior (TK 100x100)

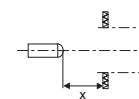
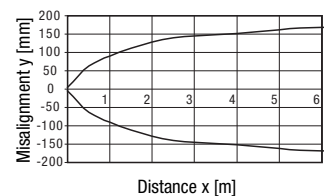

Typ. performance reserve

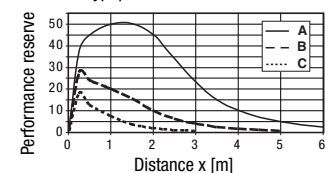

- A TKS 100x100
- B TKS 40x60
- C TKS 20x40

## Remarks

### Operate in accordance with intended use!

- ⚠ This product is not a safety sensor and is not intended as personnel protection.
- ⚠ The product may only be put into operation by competent persons.
- ⚠ Only use the product in accordance with the intended use.

**PRK 28 Retro-reflective photoelectric sensors for semi-transparent media**

**Order guide**

The sensors listed here are preferred types; current information at [www.leuze.com](http://www.leuze.com).

		Designation	Part no.
<b>With 4-pin M12 connector</b>	Pin 4: PNP light switching, pin 2: PNP dark switching	PRK 28.3/4P-M12	50122585
	Pin 4: NPN light switching, pin 2: NPN dark switching	PRK 28.3/2N-M12	50122587
<b>With 200mm cable and M12 connector</b>	Pin 4: PNP light switching, pin 2: PNP dark switching	PRK 28.3/4P-200-M12	50130047
	Pin 4: NPN light switching, pin 2: NPN dark switching	PRK 28.3/2N-200-M12	50130049
<b>With cable, cable length 2m</b>	Pin 4: PNP light switching, pin 2: PNP dark switching	PRK 28.3/4P	50122586
	Pin 4: NPN light switching, pin 2: NPN dark switching	PRK 28.3/2N	50122588

**Part number code**

		P	R	K	2	8	.	3	/	4	P	-	2	0	0	-	M	1	2	
<b>Operating principle</b>		Polarized retro-reflective photoelectric sensor																		
<b>Series</b>		28 Series																		
<b>Equipment</b>		Teach-in via teach button																		
<b>Switching output/function /OUT1/OUT2 (OUT1 = Pin 4, OUT2 = Pin 2)</b>																				
<b>4</b>	PNP, light switching																			
<b>P</b>	PNP, dark switching																			
<b>2</b>	NPN, light switching																			
<b>N</b>	NPN, dark switching																			
<b>X</b>	Pin not used																			
<b>Electrical connection</b>																				
<b>-M12</b>	M12 connector, 4-pin																			
<b>N/A</b>	Cable, standard length 2m																			
<b>-200-M12</b>	200mm cable with M12 connector																			

**Sensor adjustment (teach) via teach button**



- **The sensor is factory-adjusted for maximum operating range.**  
Recommendation: teach only if the desired objects are not reliably detected.
- **Prior to teaching: Clear the light path to the reflector!**  
The device setting is stored in a fail-safe way. A reconfiguration following voltage interruption or switch-off is thus not required.

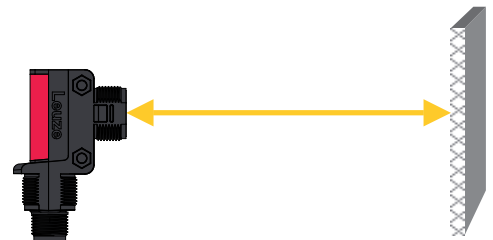

**Standard teaching for average sensor sensitivity**

- Press teach button until both LEDs flash **simultaneously**.
- Release teach button.
- Ready.



After the standard teaching, the sensor switches when half of the light beam is covered by the object.

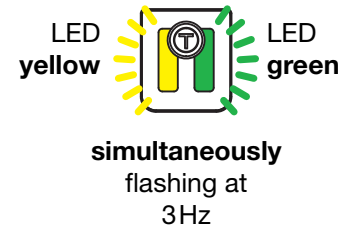
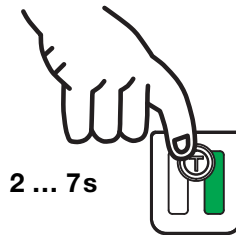

**Teaching for increased sensor sensitivity**

- Press teach button until both LEDs flash **alternatingly**.
- Release teach button.
- Ready.



After the teaching for increased sensor sensitivity, the sensor switches when about 25 % of the light beam are covered by the object.

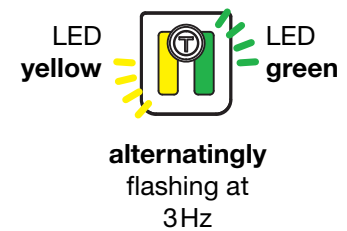
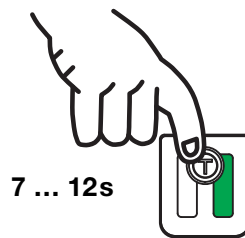

**Teaching for maximum operating range (factory setting at delivery)**

- **Prior to teaching:** Cover the light path to the reflector!
- Procedure as for standard teaching.

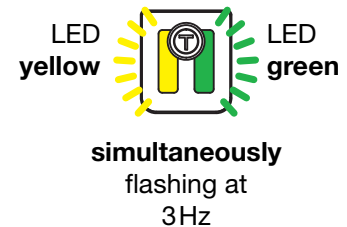
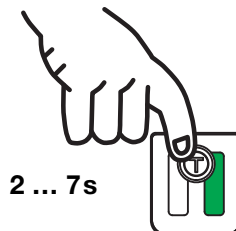
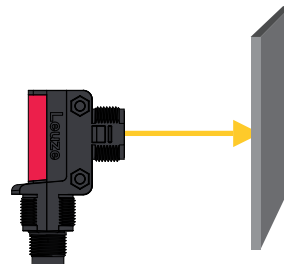

**Adjusting the switching behavior of the switching output – light/dark switching**

This function permits inversion of the sensors' switching logic.

- Press the teach button until only the green LED flashes. The yellow LED then shows the inverted switching logic:

- ON** = switching outputs light switching (in the case of complementary sensors, Q1 (pin 4) light switching, Q2 (pin 2) dark switching), this means output active when object is detected.
- OFF** = switching outputs dark switching (in the case of complementary sensors, Q1 (pin 4) dark switching, Q2 (pin 2) light switching), this means output inactive when object is detected.

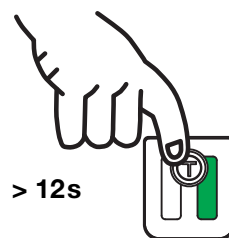

- LED yellow  
ON = light switching
- OFF = dark switching

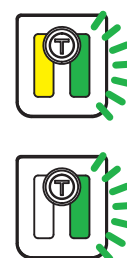

LED green flashes with 3Hz

- Release teach button.
- Ready.