

PRK18B / RK18B

Retro-reflective sensors for bottles and tape

en 02-2014/01 50121193-01



Dimensioned drawing

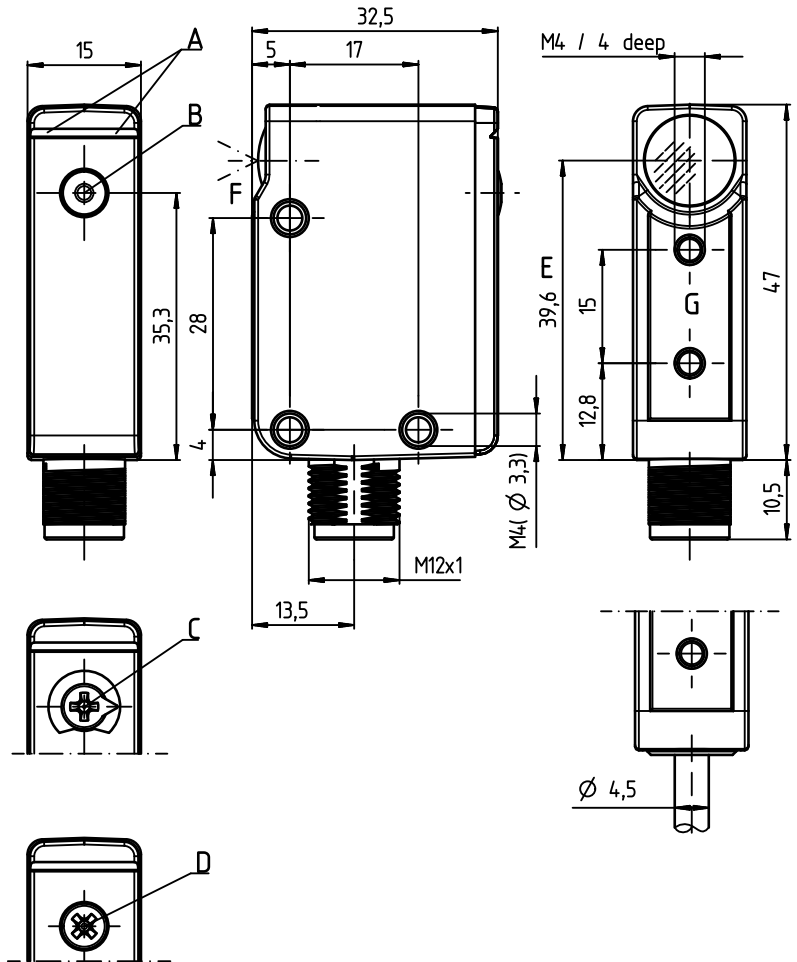

- A Display
- B Teach button
- C 270° potentiometer
- D 11-turn potentiometer
- E Optical axis
- F Optical accuracy
- G Reference plane for F

10 - 30 V DC  
 0 ... 4.8m  
 1,5 kHz

- Retro-reflective photoelectric sensors with autocollimation optics for reliable detection of highly transparent bottles and tape
- User-controlled sensitivity adjustment via 11-turn potentiometer or teach button
- Temperature compensation  $\pm 20^{\circ}\text{C}$
- High optical accuracy through calibrated optical system

Electrical connection

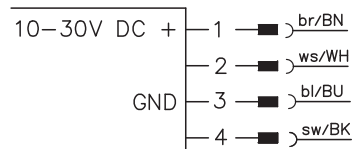

	Pin 1	Pin 2	Pin 3	Pin 4
PRK18B.T2/4P-M12	+	PNP dark	GND	PNP light
PRK18B.XT2/4P-M12	+	PNP dark	GND	PNP light
PRK18B.T2/4X-M12	+	NC	GND	PNP light
PRK18B.T2/PX-M12	+	NC	GND	PNP dark
PRK18B.T2/NX-M12	+	NC	GND	NPN dark
PRK18B.T2/4P-6000	+	PNP dark	GND	PNP light
PRK18B.T2/2N-6000	+	NPN dark	GND	NPN light
PRK18B.T3/4P-M12	+	PNP dark	GND	PNP light
PRK18B.XT3/4P-M12	+	PNP dark	GND	PNP light
PRK18B.T3/2N-M12	+	NPN dark	GND	NPN light
RK18B.T2/4P-M12	+	PNP dark	GND	PNP light
RK18B.T2/2N-M12	+	NPN dark	GND	NPN light

Accessories:

(available separately)

- Mounting system (BTU 200, BT 95)
- M12 connection technology (K-D M12)
- Reflectors (TK, MTK)
- Reflective tape (REF)
- Deflecting mirrors (US18B)

We reserve the right to make changes • DS\_PRK18BRK18B\_en\_50121193\_01.fm

## Specifications

### Optical data

Typ. op. range limit (TK(S) 100x100) <sup>1)</sup>	0 ... 4.8m
Operating ranges <sup>2)</sup>	see tables
Light source <sup>3)</sup>	LED (modulated light)
Wavelength	620nm (visible red light)
Optical accuracy	type dependent (see order guide)

### Timing

Switching frequency	1500Hz
Response time	0.333ms
Jitter time	110µs
Delay before start-up	< 300ms

### Electrical data

Operating voltage UB <sup>4)</sup>	10 ... 30VDC (incl. residual ripple)
Residual ripple	≤ 15% of UB
Open-circuit current	≤ 18mA
Switching outputs/functions	/4P 2 PNP switching outputs, antivalent /4X 1 PNP switching output, light switching /PX 1 PNP switching output, dark switching /2N 2 NPN switching outputs, antivalent /2X 1 NPN switching output, light switching /NX 1 NPN switching output, dark switching
Signal voltage high/low	≥ (UB-2V) ≤ 2V
Output current	max. 100mA
Sensitivity	adjustable via 11-turn potentiometer or teach button (see order guide)

### Indicators

Green LED ready

#### Sensors with 11-turn potentiometer:

Yellow LED, flashing slowly (6Hz) operating pt. 11%: clear glass, tape > 20µm  
Yellow LED, flashing quickly (15Hz) operating pt. 35%: colored glass  
Yellow LED, continuous light operating pt. > 35%: non transparent media

#### Sensors with teach button:

Yellow LED, continuous light light path free (during operation)

### Mechanical data

Housing <sup>5)</sup>	diecast zinc, chemically nickel-plated
Connector	diecast zinc, chemically nickel-plated
Optics	glass
Operation	11-turn potentiometer or teach button
Weight	with M12 connector: 60g with 6000mm cable: 240g M12 connector, 4-pin cable 6000mm, 4 x 0.20mm <sup>2</sup>
Connection type	

### Environmental data

Ambient temp. (operation/storage)	-40°C ... +60°C / -40°C ... +70°C
Protective circuit <sup>6)</sup>	2, 3
VDE safety class <sup>7)</sup>	III
Protection class	IP67, IP 69K
Light source	exempt group (in acc. with EN 62471)
Standards applied	IEC 60947-5-2
Certifications	UL 508, C22.2 No.14-13 <sup>4)</sup> <sup>8)</sup>
Chemical resistance	tested in accordance with ECOLAB

- 1) Typ. operating range limit: max. attainable range without performance reserve
- 2) Operating range: recommended range with performance reserve
- 3) Average life expectancy 100,000h at an ambient temperature of 25°C
- 4) For UL applications: for use in class 2 circuits according to NEC only
- 5) Color changes due to cleaning agents do not adversely affect the coating
- 6) 2=polarity reversal protection, 3=short circuit protection for all transistor outputs
- 7) Rating voltage 50V
- 8) These proximity switches shall be used with UL Listed Cable assemblies rated 30V, 0.24A min, in the field installation, or equivalent (categories: CYJV/CYJV7 or PVVA/PVVA7)

## Tables

Reflectors	Operating range
1 TK(S) 100x100	0 ... 4.0m
2 MTKS 50x50.1	0 ... 3.5m
3 TK(S) 40x60	0 ... 3.0m
4 TK(S) 30x50	0 ... 1.7m
5 TK(S) 20x40	0 ... 1.4m
6 Tape 6 50x50	0 ... 1.4m

1	0	4.0	4.8
2	0	3.5	4.2
3	0	3.0	3.6
4	0	1.7	2.0
5	0	1.4	1.7
6	0	1.4	1.7

□ Operating range [m]  
 ▒ Typ. operating range limit [m]

TK ... = adhesive  
 TK(S) ... = screw type  
 Tape 6 = adhesive

## Diagrams

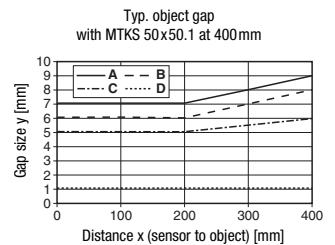

- A 11% sensor sensitivity
- B 18% sensor sensitivity
- C 35% sensor sensitivity
- D 100% sensor sensitivity

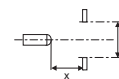

## Remarks

- **Approved purpose:**  
 This product may only be used by qualified personnel and must only be used for the approved purpose. This sensor is not a safety sensor and is not to be used for the protection of persons.
- **RK18B models:**  
 In case of reflective objects, these models must be mounted approx. 5° inclined vis-à-vis the object in order to avoid direct reflections.
- **Reflectors:**  
 The light spot may not extend beyond the reflector. Preferably use MTK(S) reflectors or reflective tape 6.

## PRK18B / RK18B

## Retro-reflective sensors for bottles and tape

### Part number code

P	R	K	1	8	B	.	F	X	T	T	3	/	4	P	-	M	1	2
---	---	---	---	---	---	---	---	---	---	---	---	---	---	---	---	---	---	---

#### Operating principle

<b>PRK</b>	Retro-reflective photoelectric sensor for bottles
<b>RK</b>	Retro-reflective photoelectric sensor for tape (Function against any reflective tapes and glass triple reflectors)

#### Series

<b>18B</b>	18B series
------------	------------

#### Timing

<b>F</b>	High speed
<b>free</b>	Standard

#### Optical accuracy

<b>X</b>	Optical axis aligned, shift angle $\leq \pm 0.25^\circ$
<b>free</b>	Standard

#### Detection properties

<b>T</b>	Setting of 11% is possible
<b>free</b>	Setting of 11% is not possible

#### Tracking function available

<b>T 1)</b>	Tracking function/contamination compensation
<b>free</b>	No tracking function

#### Setting

<b>1</b>	270° potentiometer
<b>2</b>	11-turn potentiometer
<b>3</b>	Teach button
<b>free</b>	No setting

#### Pin assignment of connector pin 4 / black cable wire

<b>2</b>	NPN, light switching
<b>N</b>	NPN, dark switching
<b>4</b>	PNP, light switching
<b>P</b>	PNP, dark switching
<b>L</b>	IO-Link

#### Pin assignment of connector pin 2 / white cable wire

<b>X</b>	Not assigned
<b>2</b>	NPN, light switching
<b>N</b>	NPN, dark switching
<b>4</b>	PNP, light switching
<b>P</b>	PNP, dark switching
<b>T</b>	Teach input

#### Connection technology

<b>M12</b>	M12 connector, 4-pin
<b>6000</b>	Cable 6 m

1) Only possible in conjunction with the detection property "T".

## Order guide

The sensors listed here are preferred types; current information at [www.leuze.com](http://www.leuze.com).

Selection table		Order code →												
Equipment ↓		PRK18B.T2/4P-M12 Part no. 50117363	PRK18B.XT2/4P-M12 Part no. 50124945	PRK18B.T2/4X-M12 Part no. 50117365	PRK18B.T2/PX-M12 Part no. 50117361	PRK18B.T2/NX-M12 Part no. 50117364	PRK18B.T2/4P-6000 Part no. 50117362	PRK18B.T2/2N-6000 Part no. 50117360	PRK18B.T3/4P-M12 Part no. 50117367	PRK18B.XT3/4P-M12 Part no. 50124944	PRK18B.T3/2N-M12 Part no. 50117366	RK18B.T2/4P-M12 Part no. 50117379	RK18B.T2/2N-M12 Part no. 50117377	
Switching output	1 x PNP, light switching			●										
	1 x PNP, dark switching				●									
	2 x PNP, antivalent	●	●				●		●	●		●		
	1 x NPN, dark switching					●								
	2 x NPN, antivalent							●					●	
	1 x IO-Link, 1 x PNP, dark switching											●		
	1 x IO-Link, 1 x NPN, dark switching													●
Optical accuracy	calibrated $\leq \pm 0.25^\circ$		●							●				
Switching frequency/ response time/jitter	500Hz/1 ms/320µs													
	1500Hz/333µs/110µs	●	●	●	●	●	●	●	●	●	●	●	●	
	5000Hz/100µs/32µs													
Detection properties	highly transparent bottles and glasses	●	●	●	●	●	●	●	●	●	●			
	highly transparent tape < 20µm thick											●	●	
	transparent containers	●	●	●	●	●	●	●	●	●	●			
Tracking function	exists													
Setting	270° potentiometer													
	11-turn potentiometer	●	●	●	●	●	●	●				●	●	
	teach button								●	●	●			
Connection technology	M12 connector	●	●	●	●	●			●	●	●	●	●	
	cable, 6000mm						●	●						



**PRK18B / RK18B**

**Retro-reflective sensors for bottles and tape**

**Sensor setting via 11-turn potentiometer (user guidance)**

The sensor is factory-adjusted for maximum operating range (potentiometer on right limit stop).

- **Before making adjustments: ensure that the light path to the reflector is clear!**
- **Set the desired sensor sensitivity according to the following table, via the 11-turn potentiometer on the back of the housing:**

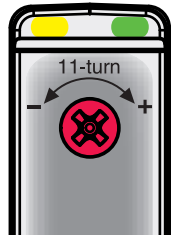
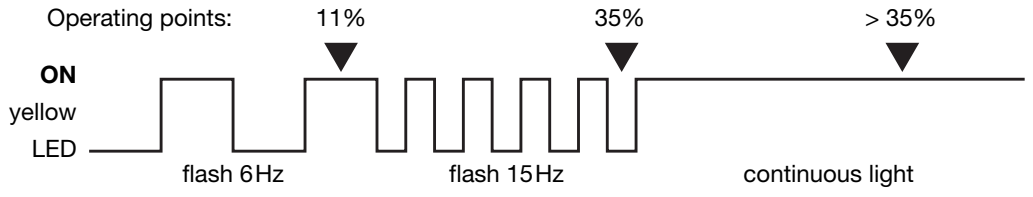
	Operating point		
	clear glass, tape > 20µm	colored glass	non transparent media
<b>Sensor sensitivity</b>	11%	35%	> 35%
<b>Setting / yellow LED</b>	<p><b>Transition</b> flash 15Hz / flash 6Hz</p> 	<p><b>Transition</b> continuous light / flash 15Hz</p> 	<p><b>continuous light</b></p> 
<b>Flashing diagram</b>	<p>Operating points: 11% 35% &gt; 35%</p> 		

**Sensor setting via teach button**



- **The sensor is factory-adjusted for maximum operating range.**  
Recommendation: teach only if the desired objects are not reliably detected.
- **Prior to teaching:**  
**Clear the light path to the reflector!**  
The device setting is stored in a fail-safe way. A reconfiguration following voltage interruption or switch-off is thus not required.

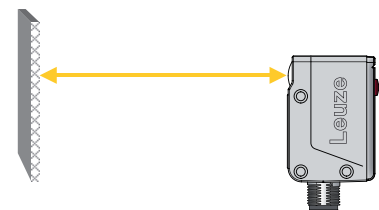

**Teaching for 11% sensor sensitivity (clear glass, tape > 20µm)**

- **Press teach button until both LEDs flash simultaneously.**
- **Release teach button.**
- **Ready.**



After the teaching, the sensor switches when about 11% of the light beam are covered by the object.

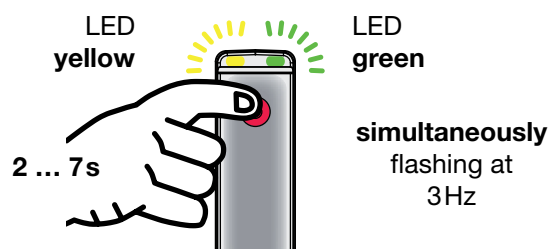

**Teaching for 18% sensor sensitivity (colored glass)**

- Press teach button until both LEDs flash alternatingly.
- Release teach button.
- Ready.



After the teaching, the sensor switches when about 18% of the light beam are covered by the object.



**Teaching for maximum operating range (factory setting at delivery)**

- Prior to teaching:  
Interrupt the light path to the reflector!

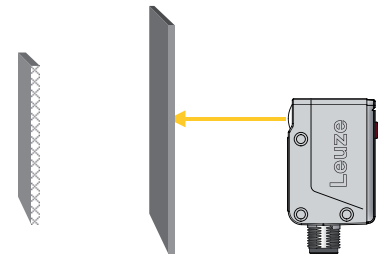

- Press teach button until both LEDs flash simultaneously.
- Release teach button.
- Ready.

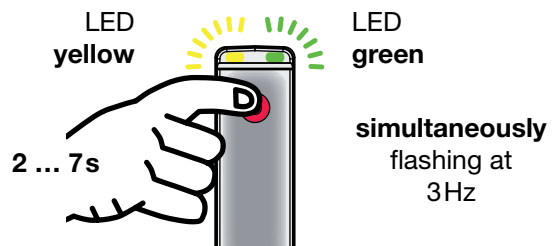

**Adjusting the switching behavior of the switching output – light/dark switching**

- Press teach button until only the green LED flashes
- Release the teach button. The yellow LED displays the light/dark switching status for 2s:
  - Yellow LED ON = switching outputs inverted
  - Yellow LED OFF = switching outputs not inverted (factory settings)
- After 2s: ready

