

ifm electronic



Operating instructions
Electronic pressure sensor

efector500[®]

PN22xx

PN26xx

UK

80229687 / 00 05 / 2015

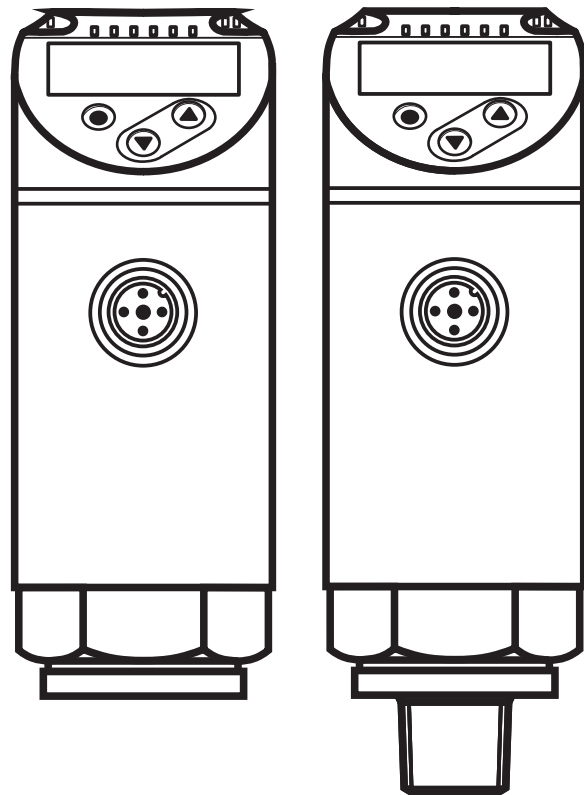

Contents

1	Preliminary note.....	4
1.1	Symbols used	4
2	Safety instructions	4
3	Functions and features	4
3.1	Applications	5
4	Function.....	6
4.1	Communication, parameter setting, evaluation	6
4.2	Switching function.....	7
4.3	Analogue function	8
4.4	IO-Link.....	9
5	Installation.....	10
6	Electrical connection.....	11
7	Operating and display elements	12
8	Menu.....	13
8.1	Menu structure: main menu.....	13
8.2	Explanation of the menu	14
8.2.1	Explanation of the menu level 1	14
8.2.2	Explanation of the menu level 2	14
9	Parameter setting	15
9.1	Parameter setting in general	15
9.2	Configure display (optional).....	17
9.3	Set output signals	18
9.3.1	Set output functions.....	18
9.3.2	Define switching limits for the hysteresis function	18
9.3.3	Define switching limits for the window function	18
9.3.4	Scaling of the analogue value	19
9.4	User settings (optional).....	19
9.4.1	Set delay for the switching outputs.....	19
9.4.2	Set output logic for the switching outputs	19
9.4.3	Set damping for the switching signal	19
9.4.4	Damping for analogue output	19
9.4.5	Zero-point calibration.....	19

9.4.6	Read min/max values for the system pressure	20
9.4.7	Reset all parameters to factory setting	20
9.4.8	Set colour change of the display	20
9.4.9	Graphical depiction of the colour change of the display	21
10	Operation	23
10.1	Read set parameters	23
10.2	Self-diagnosis / error indications	24
11	Technical data and scale drawing	25
11.1	Setting ranges	25
11.2	Further technical data	27
12	Factory setting	28

1 Preliminary note

1.1 Symbols used

► Instructions

> Reaction, result

[...] Designation of keys, buttons or indications

→ Cross-reference



Important note

Non-compliance may result in malfunction or interference



Information

Supplementary note

2 Safety instructions

- Please read this document prior to set-up of the unit. Ensure that the product is suitable for your application without any restrictions.
- If the operating instructions or the technical data are not adhered to, personal injury and/or damage to property can occur.
- Check the compatibility of the product materials with the media to be measured in all applications.
- Correct condition of the device for the operating time can only be guaranteed if the device is only used for media to which the wetted materials are sufficiently resistant → 3.1 Applications.
- If the devices are used in gas applications with pressures > 362 psi (25 bar) the notes in chapter 3.1 for devices with the marking **), must be absolutely observed!



The responsibility whether the measurement device is suitable for the respective application lies with the operator. The manufacturer assumes no liability for consequences of misuse by the operator. Improper installation and use of the devices result in a loss of the warranty claims.

3 Functions and features

The device monitors the system pressure of machines and installations.

3.1 Applications

Type of pressure: Relative pressure

Order number	Measuring range		Pressure resistance (max. permissible pressure) *)		Bursting pressure	
	psi	bar	psi	bar	psi	bar
Pressure sensors with ¼ - 18 NPT internal thread						
PN2270	0...5800	0...400	11580	800	24650	1700
PN2271	0...3625	0...250	7250	500	17400	1200
PN2292**	0...1450	0...100	4350	300	9400	650
PN2293**	-14.5...362.5	-1...25	2175	150	5075	350
PN2294**	-14.6...145	-1...10	1087	75	2175	150
PN2296	-1.8...36.25	-0.125...2.5	290	20	725	50
	psi	mbar	psi	mbar	psi	mbar
PN2299	-14.5...14.5	-1000...1000	290	20000	725	50000
PN2297	-0.72...14.5	-50...1000	145	10000	450	30000
PN2298	--	-12.5...250	--	10000	--	30000
Pressure sensors with ¼ - 18 NPT external thread						
	psi	bar	psi	bar	psi	bar
PN2670	0...5800	0...400	11580	800	24650	1700
PN2671	0...3625	0...250	7250	500	17400	1200
PN2692**	0...1450	0...100	4350	300	9400	650
PN2693**	-14.5...362.5	-1...25	2175	150	5075	350
PN2694**	-14.6...145	-1...10	1087	75	2175	150
PN2696	-1.8...36.25	-1.25...2.5	290	20	725	50
	psi	mbar	psi	mbar	psi	mbar
PN2699	-14.5...14.5	-1000...1000	290	20000	725	50000
PN2697	-0.72...14.5	-50...1000	145	10000	450	30000
PN2698		-12.5...250	--	10000	--	30000
*) With static overload pressure or max. 100 million pressure cycles. **) Use devices with a measuring range ≥ 3625 psi (250 bar) for gas applications > 362 psi (25 bar)!						
MPa = (measured value in bar) ÷ 10 kPa = (measured value in bar) x 100						

UK



Avoid static and dynamic overpressure exceeding the specified overload pressure by taking appropriate measures.

The indicated bursting pressure must not be exceeded.

Even if the bursting pressure is exceeded only for a short time, the unit may be destroyed. ATTENTION: Risk of injury!



The units are vacuum resistant. With a nominal pressure range $\leq 4,35$ psi (300 mbar) observe the specifications in the data sheet!



Pressure Equipment Directive (PED):

The units comply with the Pressure Equipment Directive and are designed and manufactured for group 2 fluids in accordance with the sound engineering practice.

Use of group 1 fluids on request!

4 Function

- The unit displays the current system pressure.
- It generates output signals according to the operating mode and the parameter setting.
- It moreover provides the process data via IO-Link.
- The unit is laid out for fully bidirectional communication. So, the following options are possible:
 - Remote display: reading and display of the current system pressure.
 - Remote parameter setting: reading and changing the current parameter setting.
 - IO-Link parameter setting → 4.4.

4.1 Communication, parameter setting, evaluation

OUT1 (pin 4)	<ul style="list-style-type: none">• Switching signal for system pressure limit value• Communication via IO-Link
OUT2 (pin 2)	<ul style="list-style-type: none">• Switching signal for system pressure limit value• Analogue signal 4...20 mA / 0...10 V

4.2 Switching function

OUTx changes its switching status if it is above or below the set switching limits (SPx, rPx). The following switching functions can be selected:

- Hysteresis function / normally open: [ou1/ou2] = [Hno] (→ fig. 1).
- Hysteresis function / normally closed: [ou1/ou2] = [Hnc] (→ fig. 1).

First the set point (SPx) is set, then the reset point (rPx).

The hysteresis defined remains even if SPx is changed again.

- Window function / normally open: [ou1/ou2] = [Fno] (→ fig. 2).
- Window function / normally closed: [ou1/ou2] = [Fnc] (→ fig. 2).

The width of the window can be set by means of the difference between FHx and FLx. FHx = upper value, FLx = lower value.

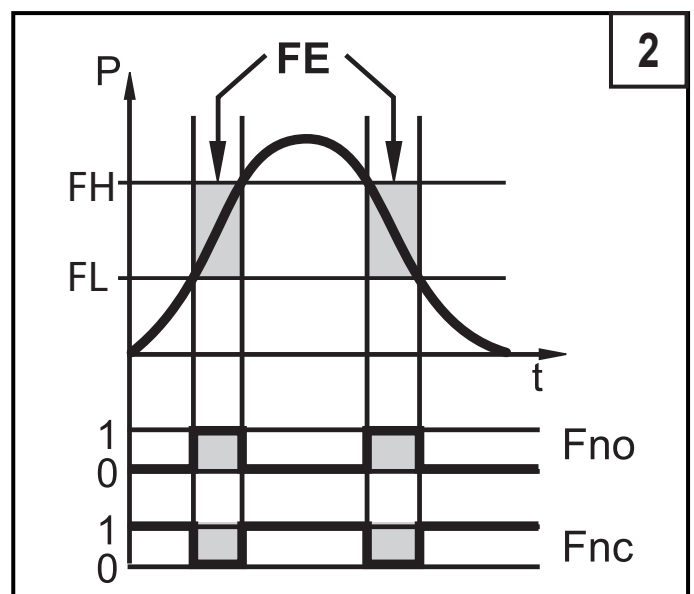
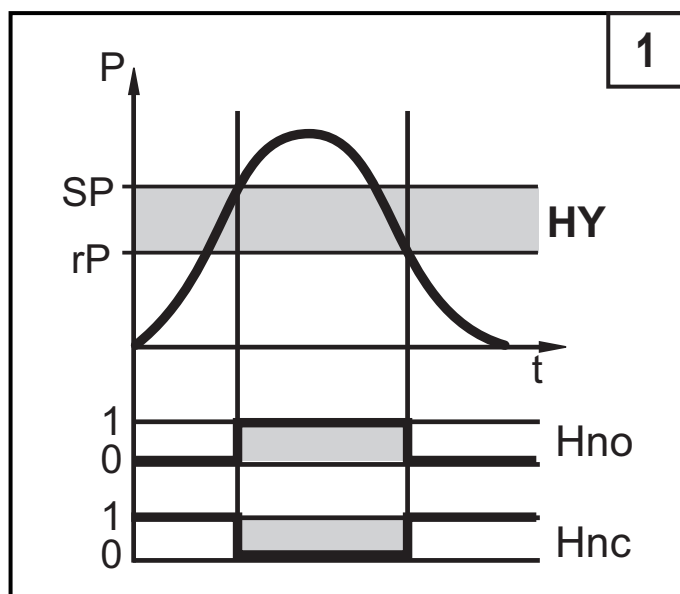

P = system pressure; HY = hysteresis; FE = window



When set to the window function the set and reset points have a fixed hysteresis of 0.25 % of the final value of the measuring span.

4.3 Analogue function

OUT2 is an analogue output:

- [ou2] defines whether the set measuring range is provided as 4...20 mA ([ou2]= [I]) or as 0...10 V ([ou2] = [U]).
- Analogue start point [ASP2] determines at which measured value the output signal is 4 mA or 0 V.
- Analogue end point [AEP2] determines at which measured value the output signal is 20 mA or 10 V.

Minimum distance between [ASP2] and [AEP2] = 20 % of the measuring span.

Voltage output 0...10 V:

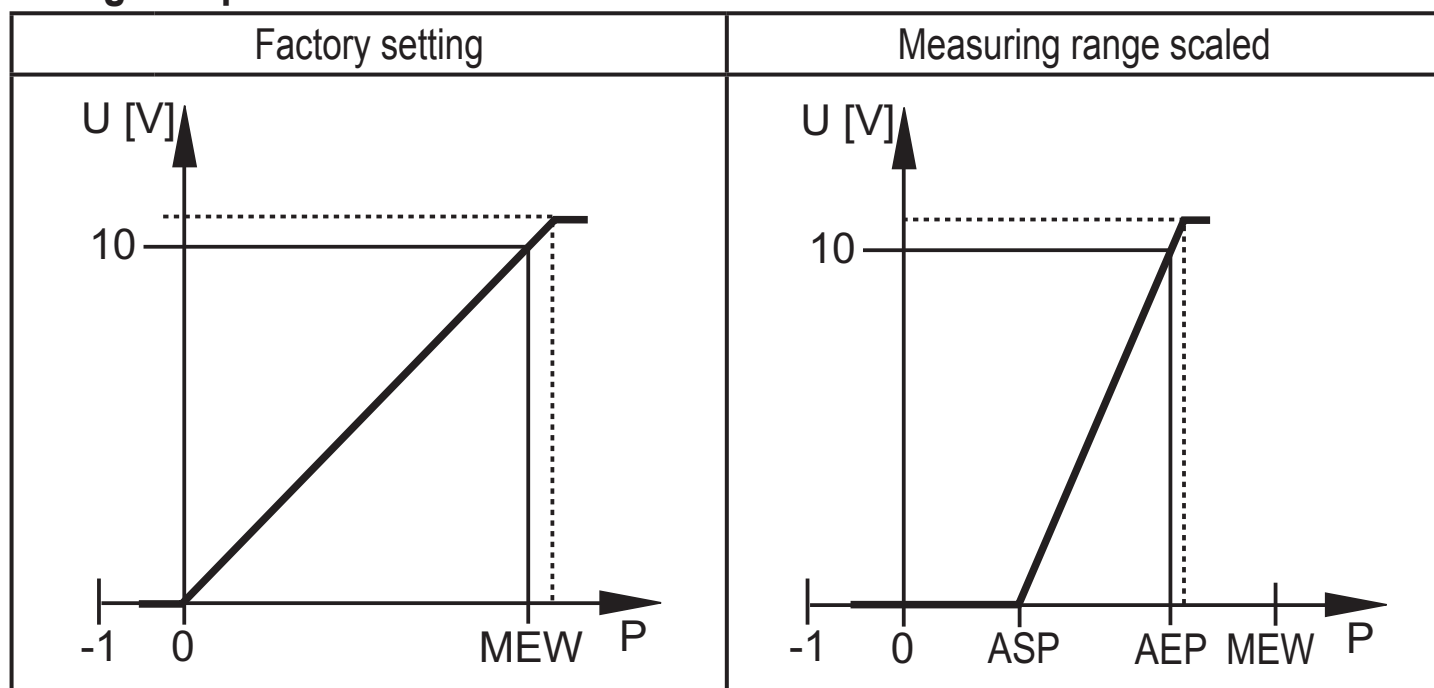

P = System pressure
 VMR = Final value of the measuring range
 ASP = Analogue start point [ASP2]
 AEP = Analogue end point [AEP2]

In the measuring range of the respective unit the output signal is between 0 and 10 V.

It is also indicated:

- System pressure above [AEP2]: 10...10.3 V
- Fault indication according to Namur: 11 V

Current output 4...20 mA

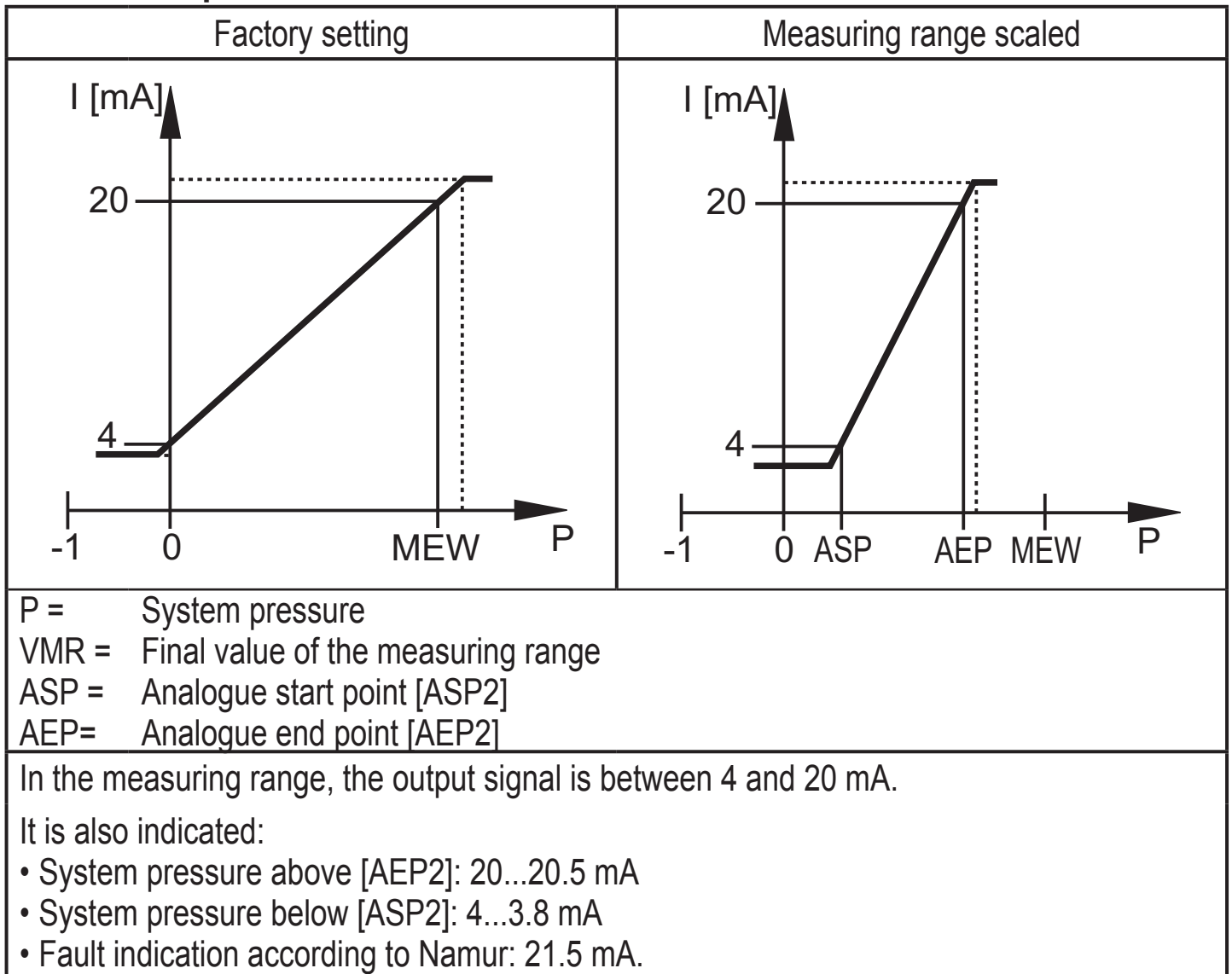

UK

4.4 IO-Link

General information

This unit has an IO-Link communication interface which requires an IO-Link-capable module (IO-Link master) for operation.

The IO-Link interface enables direct access to the process and diagnostic data and provides the possibility to set the parameters of the unit during operation.

In addition communication is possible via a point-to-point connection with a USB adapter cable.

Further information about IO-Link at www.ifm.com → "more product information" → "Specials" → "IO-Link".

Device-specific information

You can find the IODDs necessary for the configuration of the IO-Link unit and detailed information about process data structure, diagnostic information and parameter addresses at www.ifm.com → "more product information" → "Specials" → "IO-Link".

Parameter setting tools

You will find all necessary information about the required IO-Link hardware and software at www.ifm.com → "more product information" → "Specials" → "IO-Link".

5 Installation



Before installing and removing the unit: make sure that no pressure is applied to the system.

- ▶ Insert the unit in a $\frac{1}{4}$ - 18 NPT process connection.
- ▶ Tighten firmly. Recommended tightening torque: ≤ 50 Nm
Depends on lubrication, seal and pressure load!

The sensor housing can be rotated by 345° with regard to the process connection.



Do not rotate past the end stop!

6 Electrical connection



The unit must be connected by a qualified electrician.

The national and international regulations for the installation of electrical equipment must be adhered to.

Voltage supply according to EN 50178, SELV, PELV.

- ▶ Disconnect power.
- ▶ Connect the unit as follows:

Core colours			
BK	black		
BN	brown		
BU	blue		
WH	white		
			<p>OUT1: switching output or IO-Link</p> <p>OUT2: switching outputs or analogue output</p> <p>Colours to DIN EN 60947-5-2</p>
Example circuit			
2 x positive switching		2 x negative switching	
1 x positive switching / 1 x analogue		1 x negative switching / 1 x analogue	

UK

7 Operating and display elements

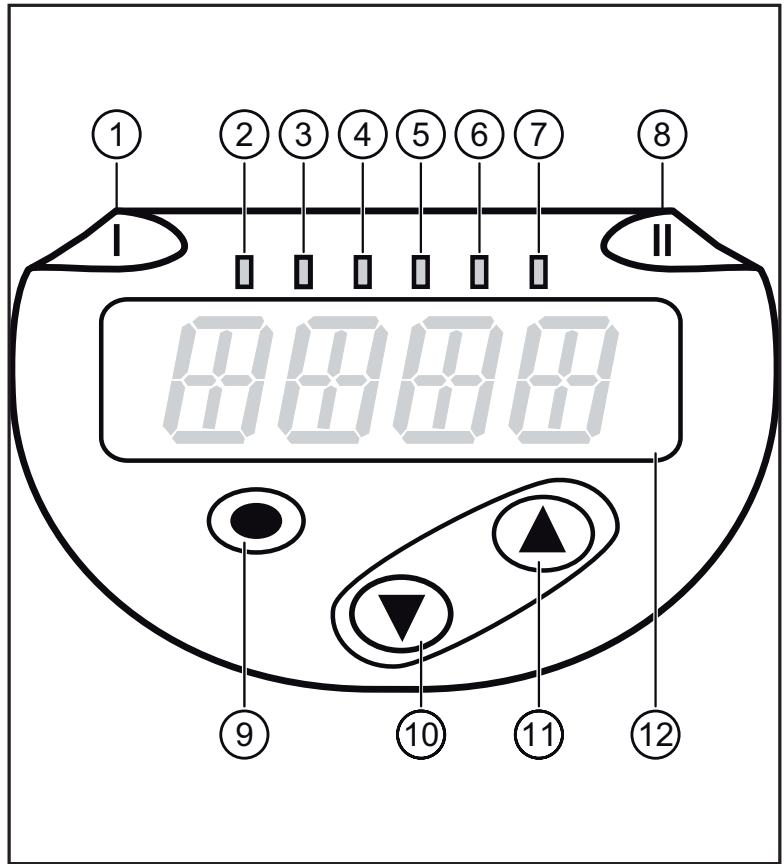

1 to 8: indicator LEDs	
LED 1	Switching status OUT1 (lights when output 1 is switched).
LED 8	Switching status OUT2 (lights when output 2 is switched).
LEDs 2 - 7	System pressure in the indicated unit of measurement (pin connection is device-specific).
9: Enter button [•]	
- Selection of the parameters and acknowledgement of the parameter values.	
10 to 11: Arrow keys up [▲] and down [▼]	
- Setting of the parameter values (scrolling by holding pressed; incremental by pressing once).	
12: Alphanumeric display, 4 digits	
- Display of the current system pressure.	
- Indication of the parameters and parameter values.	

8 Menu

8.1 Menu structure: main menu

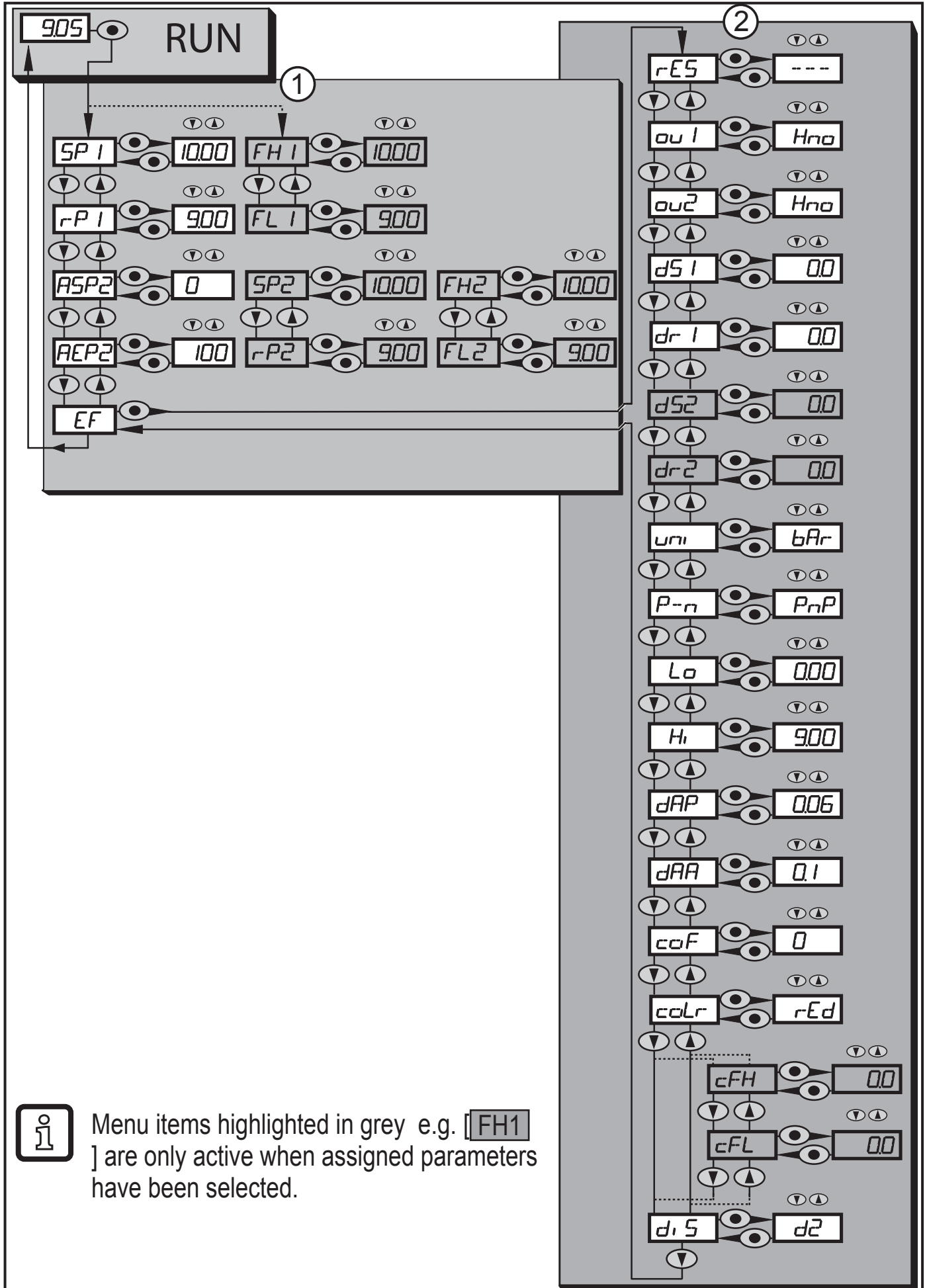

UK

8.2 Explanation of the menu

8.2.1 Explanation of the menu level 1

SPx / rPx	Upper / lower limit value for system pressure at which OUTx switches with hysteresis setting. Prerequisite: OUTx setting is [Hno] or [Hnc].
FHx / FLx	Upper / lower limit value for system pressure at which OUTx switches with window setting. Prerequisite: OUTx setting is [Fno] or [Fnc].
ASP2	Analogue start point for system pressure: measured value at which 4 mA / 0 V are provided. Prerequisite: OUT2 setting is [I] or [U].
AEP2	Analogue end point for system pressure: measured value at which 20 mA / 10 V are provided. Prerequisite: OUT2 setting is [I] or [U].
EF	Extended functions / opening of menu level 2.

8.2.2 Explanation of the menu level 2

rES	Restore factory setting.
ou1	Output function for OUT1: <ul style="list-style-type: none"> • Switching signal for the pressure limit values: hysteresis function [H ..] or window function [F ..], either normally open [. no] or normally closed [. nc].
ou2	Output function for OUT2: <ul style="list-style-type: none"> • Switching signal for the pressure limit values: hysteresis function [H ..] or window function [F ..], either normally open [. no] or normally closed [. nc]. • Analogue signal for the current system pressure: 4...20 mA [I] or 0...10 V [U].
dS1 / dS2	Switching delay for OUT1 / OUT2.
dr1 / dr2	Switch-off delay for OUT1 / OUT2.
uni	Standard unit of measurement for system pressure (display): [PSI] / [bAr] / [mbar] / [MPa] / [kPa] / [inHG] / [iH2O] / [mmWS] .
P-n	Output logic: pnp / npn.
Lo	Minimum value memory for system pressure.
Hi	Maximum value memory for system pressure.
dAP	Damping of the switch point.
dAA	Damping of the analogue output. Prerequisite: OUT2 setting is [I] or [U].
coF	Zero-point calibration.
coLr	Assignment of the display colours "red" and "green" within the measuring range.
cFH / cFL	Upper / lower value for colour change. Parameter only active after selection of a freely definable colour window in the coLr parameter: [r-cF] or [G-cF].
diS	Update rate and orientation of the display.

9 Parameter setting

During parameter setting the unit remains in the operating mode. It continues to monitor with the existing parameters until the parameter setting has been completed.

9.1 Parameter setting in general

3 steps must be taken for each parameter setting:

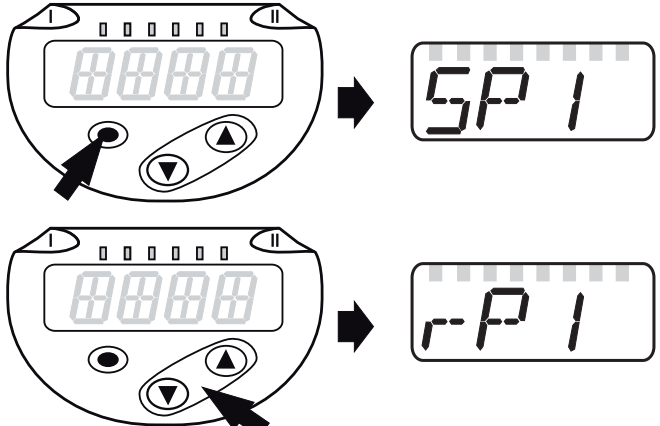
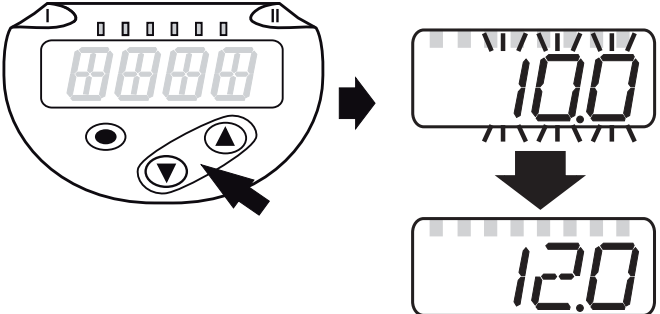
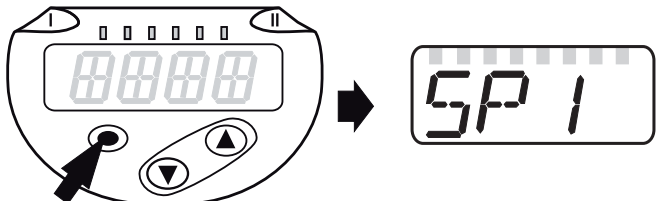
<p>1</p>	<p>Select parameter</p> <ul style="list-style-type: none"> ▶ Press [●] to get to the menu. ▶ Press [▲] or [▼] until the requested parameter is displayed. 	
<p>2</p>	<p>Set parameter value</p> <ul style="list-style-type: none"> ▶ Press [●] to edit the selected parameter. ▶ Press [▲] or [▼] for min. 1 s. > After 1 s: setting value is changed: incrementally by pressing the button once or continuously by keeping the button pressed. 	
<p>Numerical values are incremented continuously with [▲] or decremented with [▼].</p>		
<p>3</p>	<p>Acknowledge parameter value</p> <ul style="list-style-type: none"> ▶ Briefly press [●]. > The parameter is displayed again. The new setting value is saved. 	
<p>Set other parameters</p> <ul style="list-style-type: none"> ▶ Press [▲] or [▼] until the requested parameter is displayed. 		
<p>Finish parameter setting</p> <ul style="list-style-type: none"> ▶ Press [▲] or [▼] several times until the current measured value is displayed or wait for 30 s. > The unit returns to the process value display. 		

UK



If [C.Loc] is displayed when an attempt is made to modify a parameter value, a parameter setting process is active via the IO-Link communication (temporary locking).



If [S.Loc] is displayed, the sensor is permanently locked via software. This locking can only be removed with a parameter setting software.

- Change from menu level 1 to menu level 2:

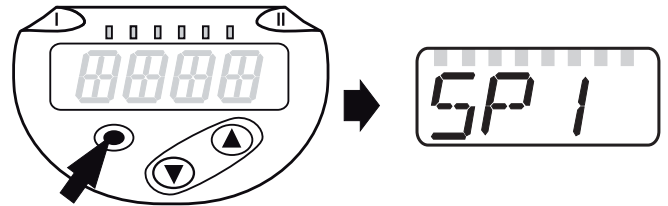
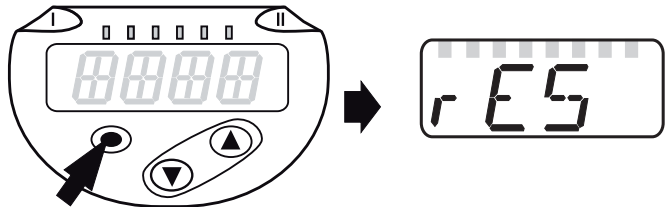
<ul style="list-style-type: none"> ▶ Press [●] to get to the menu. ▶ Press [▲] [▼] until [EF] is displayed. 	
<ul style="list-style-type: none"> ▶ Press [●]. > The first parameter of the submenu is displayed (here: [rES]). 	

- Locking / unlocking

The unit can be locked electronically to prevent unintentional settings.

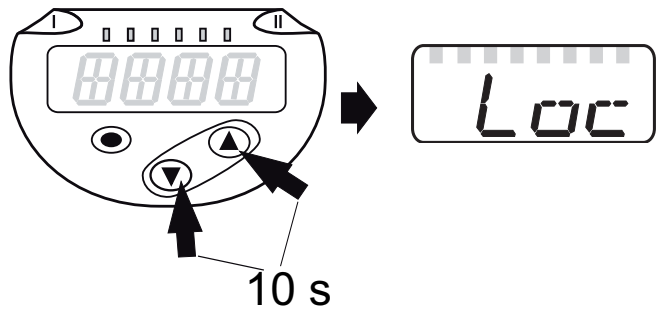
<ul style="list-style-type: none"> ▶ Make sure that the unit is in the normal operating mode. ▶ Press [▲] + [▼] simultaneously for 10 s. > [Loc] is displayed. 	
<p>During operation: [Loc] is briefly displayed if you try to change parameter values.</p>	

For unlocking:

- ▶ Make sure that the unit is in the normal operating mode.
- ▶ Press [▲] + [▼] simultaneously for 10 s.
- > [uLoc] is displayed.

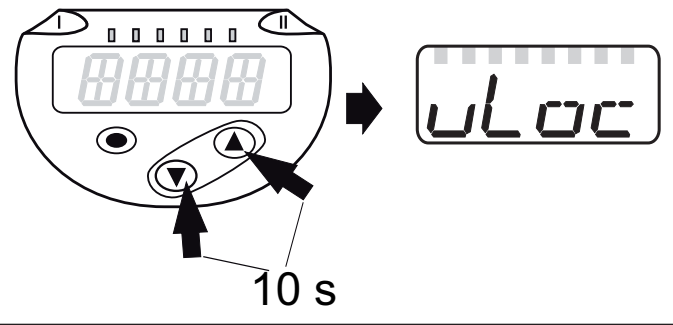

On delivery: not locked.

- Timeout:

If no button is pressed for 30 s during parameter setting, the unit returns to the operating mode with unchanged values.

UK

- Exit a parameter without adopting the settings

To exit a parameter without adopting the settings:

- ▶ Press [▲] + [▼] simultaneously.
- > Return to the menu level.

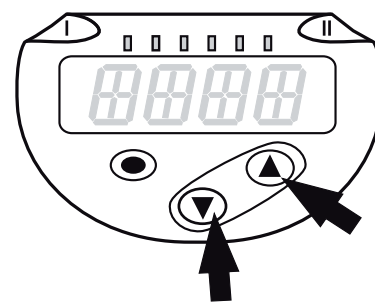

- Leaving the menu level

To leave the menu level:

- ▶ Press [▲] + [▼] simultaneously.
- > Menu level 2 changes to level 1 or level 1 changes to display.

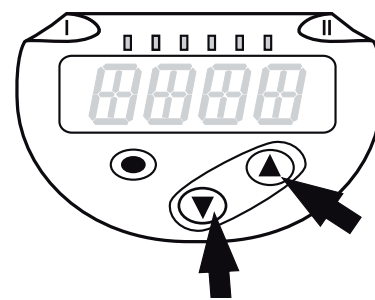



9.2 Configure display (optional)

- ▶ Select [Uni] and set the unit of measurement:
 - [PSI],
 - [bAr], [mbAr],
 - [MPA], [kPA],
 - [inHG],
 - [iH2O],
 - [mmWS]

U771





The selectable units of measurement depend on the respective unit.



<p>▶ Select [diS] and set the update rate and orientation of the display:</p> <ul style="list-style-type: none"> - [d1]: update of the measured values every 50 ms. - [d2]: update of the measured values every 200 ms. - [d3]: update of the measured values every 600 ms. - [rd1], [rd2], [rd3]: display as for d1, d2, d3; rotated by 180°. - [OFF] = The display is switched off in the operating mode. When one of the buttons is pressed, the current measured value is displayed for 30 s. The LEDs remain active even if the display is deactivated. 	
	<p>Even with unsteady pressure characteristics [d1] provides optimum readability; the corresponding algorithms are stored.</p>

9.3 Set output signals

9.3.1 Set output functions

<p>▶ Select [ou1] and set the switching function:</p> <ul style="list-style-type: none"> - [Hno] = hysteresis function/NO, - [Hnc] = hysteresis function/NC, - [Fno] = window function/NO, - [Fnc] = window function/NC. 	
<p>▶ Select [OU2] and set the analogue function:</p> <ul style="list-style-type: none"> - [Hno] = hysteresis function/NO, - [Hnc] = hysteresis function/NC, - [Fno] = window function/NO, - [Fnc] = window function/NC. - [I] = current signal 4...20 mA, - [U] = voltage signal 0...10 V. 	

9.3.2 Define switching limits for the hysteresis function

<p>▶ [ou1] / [ou2] must be set as [Hno] or [Hnc].</p> <p>▶ Select [SPx] and set the value at which the output is set.</p>	
<p>▶ Select [rPx] and set the value at which the output resets.</p> <p>[rPx] is always smaller than [SPx]. The unit only accepts values which are lower than the value for [SPx].</p>	

9.3.3 Define switching limits for the window function

<p>▶ [ou1] / [ou2] must be set as [Fno] or [Fnc].</p> <p>▶ Select [FHx] and set the upper limit value.</p>	
--	---

<p>▶ Select [FLx] and set the lower limit value. [FLx] is always lower than [FHx]. The unit only accepts values which are lower than the value for [FHx].</p>	<p>FL1 FL2</p>
---	--------------------

9.3.4 Scaling of the analogue value

<p>▶ Select [ASP2] and set the value at which 4 mA / 0 V is provided.</p>	<p>ASP2</p>
<p>▶ Select [AEP2] and set the value at which 20 mA / 10 V is provided. Minimum distance between [ASP2] and [AEP2] = 20 % of the measuring span (scaling factor 5).</p>	<p>AEP2</p>

UK

9.4 User settings (optional)

9.4.1 Set delay for the switching outputs

<p>[dS1] / [dS2] = switching delay for OUT1 / OUT2. [dr1] / [dr2] = reset delay for OUT1 / OUT2. ▶ Select [dS1], [dS2], [dr1] or [dr2] and set a value between 0 and 50 s (at 0 the delay time is not active).</p>	<p>dS1 dr1 dS2 dr2</p>
<p> For this unit the parameters [dSx] and [drx] for the set and reset points are designed strictly to the VDMA guideline.</p>	

9.4.2 Set output logic for the switching outputs

<p>▶ Select [P-n] and set [PnP] or [nPn].</p>	<p>P--n</p>
---	-------------

9.4.3 Set damping for the switching signal

<p>▶ Select [dAP] and set the damping constant in seconds (value τ: 63 %); setting range 0.000...4.000 s.</p>	<p>dAP</p>
<p> Damping affects [dAP] the switch point / process data flow (IO-Link communication) and the display.</p>	

9.4.4 Damping for analogue output

<p>▶ Select [dAA] and set the damping constant (rise time 10...90 %) in seconds; setting range 0.000...4.000 s.</p>	<p>dAA</p>
<p> Damping [dAA] only affects the analogue output / analogue signal path.</p>	

9.4.5 Zero-point calibration

<p>▶ Select [coF] and set a value between -5 % and 5 % of the final value of the measuring range (if PN2x69 and PN2x99 ± 5 % of the measuring span). The internal measured value "0" is shifted by this value.</p>	<p>coF</p>
---	------------

9.4.6 Read min/max values for the system pressure

<ul style="list-style-type: none"> ▶ Select [HI] or [Lo] and briefly press [●]. [HI] = maximum value, [Lo] = minimum value. Delete memory: ▶ Select [HI] or [Lo]. ▶ Press and hold [▲] or [▼] until [----] is displayed. ▶ Briefly press [●]. 	<p>Hi</p> <p>Lo</p>
--	---------------------

9.4.7 Reset all parameters to factory setting

<ul style="list-style-type: none"> ▶ Select [rES]. ▶ Press [●]. ▶ Press and hold [▲] or [▼] until [----] is displayed. ▶ Briefly press [●]. <p>We recommend noting down your own settings before carrying out a reset (→ 12 Factory setting).</p>	<p>r-ES</p>
---	-------------



9.4.8 Set colour change of the display

<ul style="list-style-type: none"> ▶ Select [coLr] and set the function: <ul style="list-style-type: none"> - [rEd] = display colour red (independent of the measured value). - [GrEn] = display colour green (independent of the measured value). - [r1ou] = display colour red when OUT1 switches. - [G1ou] = display colour green when OUT1 switches. - [r2ou] = display colour red when OUT2 switches ([ou2] = [Hxx] / [Fxx]). - [G2ou] = display colour green when OUT2 switches ([ou2] = [Hxx] / [Fxx]). - [r-12] = display colour red when the measured value is between the limit values of OUT1 and OUT2 ([ou2] = [Hxx] / [Fxx]). - [G-12] = display colour green when the measured value is between the limit values of OUT1 and OUT2 ([ou2] = [Hxx] / [Fxx]). - [r-cF] = display colour red when the measured value is between the freely definable limit values [cFH]*) and [cFL]*). - [G-cF] = display colour green when the measured value is between the freely definable limit values [cFH]*) und [cFL]*) <p>*) The parameters [cFL] and [cFH] can only be selected in the menu tree when [r-cF] or [G-cF] were activated.</p>	<p>coLr</p>
<ul style="list-style-type: none"> ▶ Select [cFH] and set the upper limit value. (only possible when [r-cF] or [G-cF] were activated). > The setting range corresponds to the measuring range and its minimum limit is [cFL]. 	<p>cFH</p>

- ▶ Select [cFL] and set the lower limit value (only possible when [r-cF] or [G-cF] were activated).
- > The setting range corresponds to the measuring range and its maximum limit is [cFH].

cFL

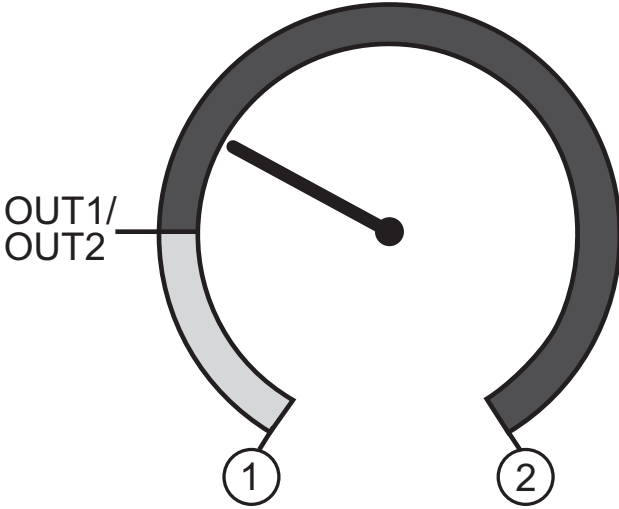
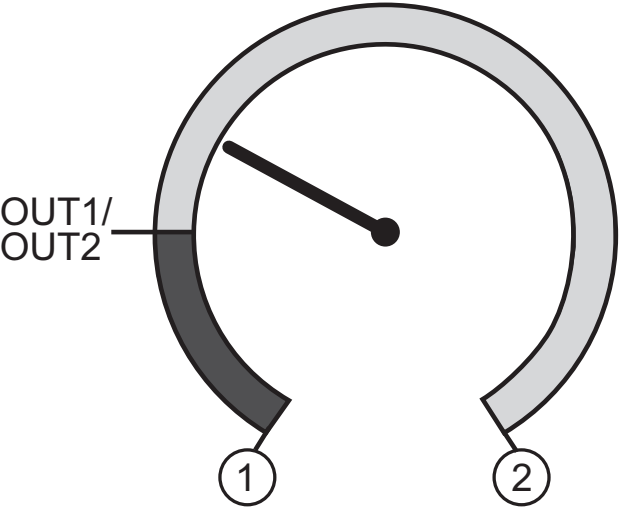
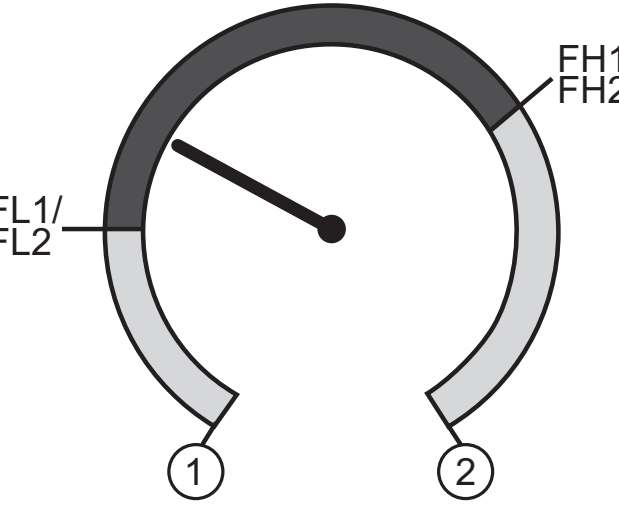
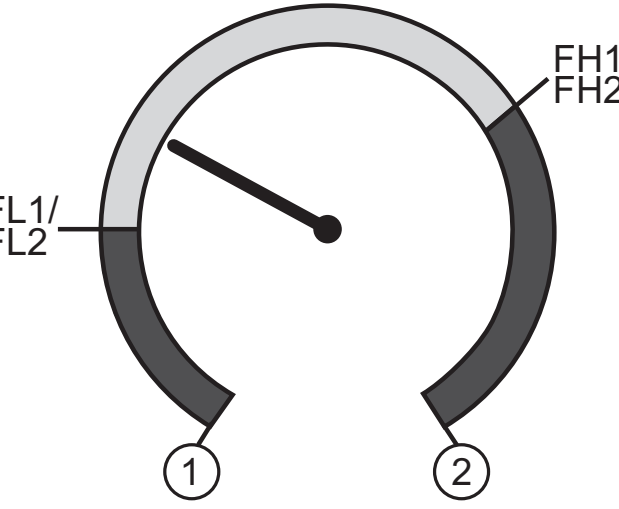
9.4.9 Graphical depiction of the colour change of the display

Display colour change for the parameters [r1ou] / [r2ou], mode hysteresis function	Display colour change for the parameters [G1ou] / [G2ou], mode hysteresis function
	
Measured value > switch point OUT1/OUT2; Display = red	Measured value > switch point OUT1/OUT2; Display = green
Display colour change for the parameters [r1ou] / [r2ou], mode window function	Display colour change for the parameters [G1ou] / [G2ou], mode window function
	
Measured value between FL1/FL2 and FH1/FH2; Display = red	Measured value between FL1/FL2 and FH1/FH2; Display = green
	Colour change display green
	Colour change display red
1	Initial value of the measuring range
2	Final value of the measuring range

UK



Representation [r-12] / [G-12] only possible when [ou2] = switching output.

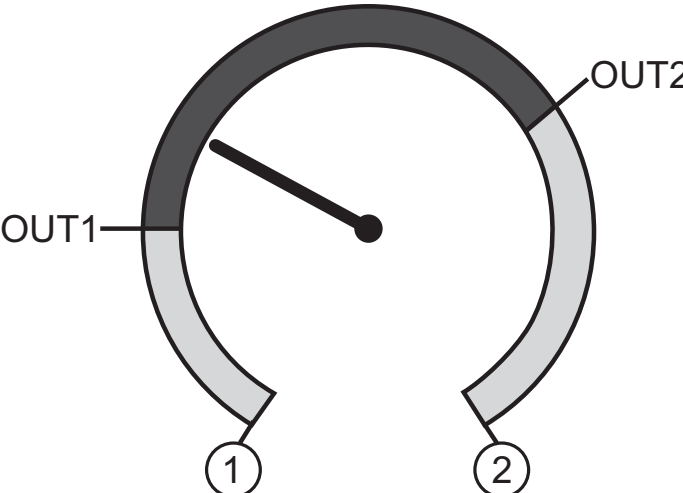
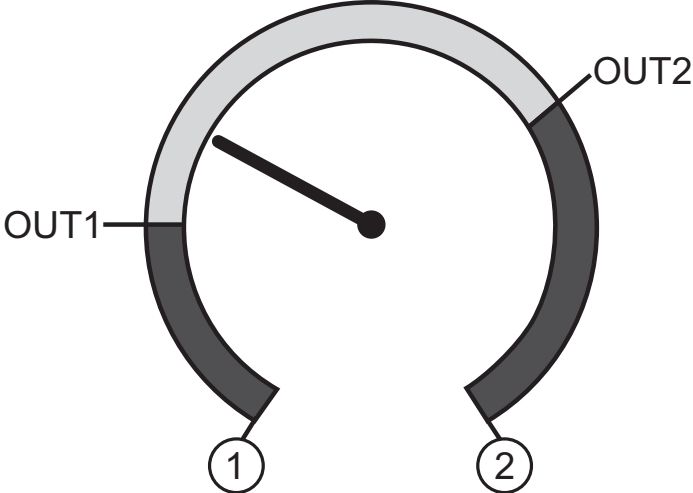

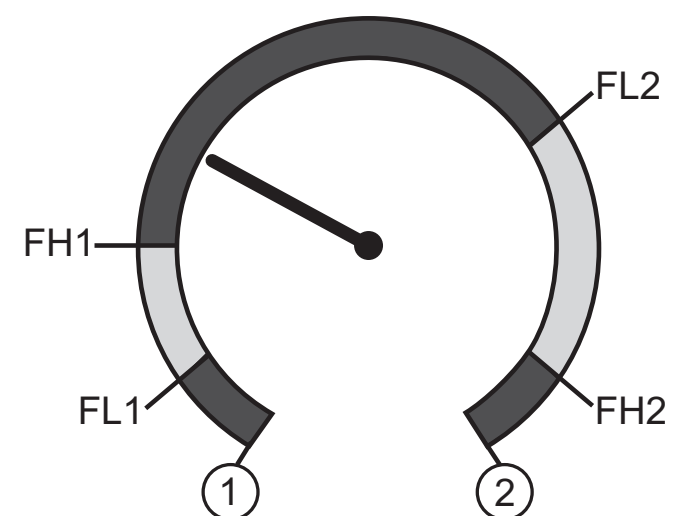
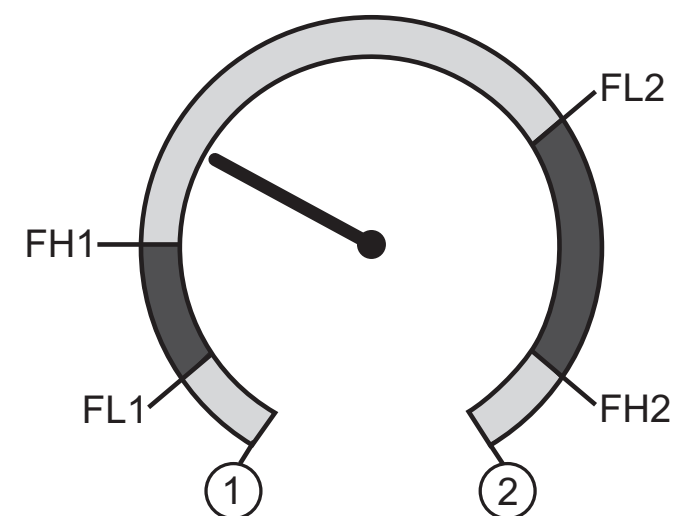
<p>Display colour change for the parameters [r-12], mode hysteresis function</p>	<p>Display colour change for the parameters [G-12], mode hysteresis function</p>
	
<p>Measured value between OUT1 and OUT2; Display = red</p>	<p>Measured value between OUT1 and OUT2; Display = green</p>

<p>Display colour change for the parameters [r-12], mode window function</p>	<p>Display colour change for the parameters [G-12], mode window function</p>
	
<p>Measured value outside FL1...FH1 and FL2...FH2; Display = red</p>	<p>Measured value outside FL1...FH1 and FL2...FH2; Display = green</p>

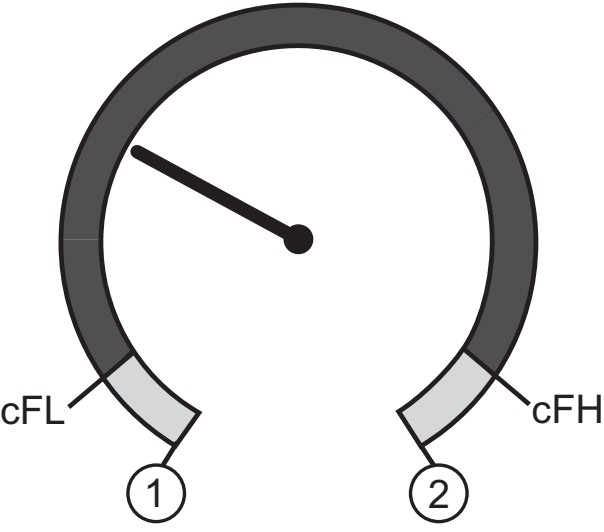
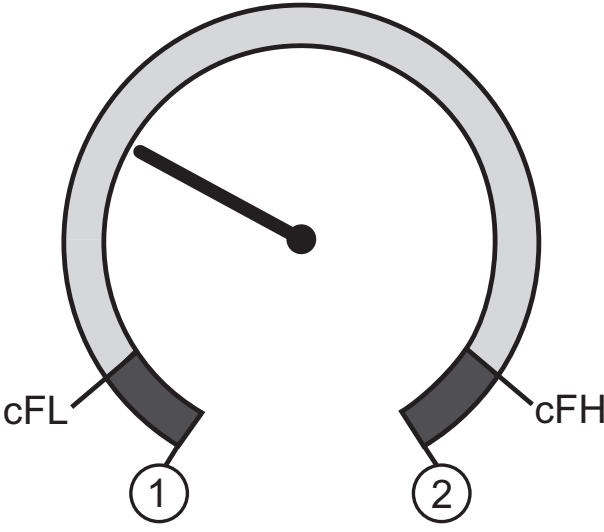
	<p>Colour change display green</p>
	<p>Colour change display red</p>
<p>1</p>	<p>Initial value of the measuring range</p>
<p>2</p>	<p>Final value of the measuring range</p>
<p>FL1 / FL2</p>	<p>Lower limit value window function outputs OUT1 / OUT2</p>
<p>FH1 / FH2</p>	<p>Upper limit value window function outputs OUT1 / OUT2</p>

Display colour change with parameter [r-cF] independent of OUT1.	Display colour change with parameter [G-cF] independent of OUT1.
	
Measured value between cFL and cFH; Display = red	Measured value between cFL and cFH; Display = green

UK

	Colour change display green
	Colour change display red
1	Initial value of the measuring range
2	Final value of the measuring range
cFL	Lower limit value (independent of the output function)
cFH	Upper limit value (independent of the output function)

10 Operation

After power on, the unit is in the Run mode (= normal operating mode). It carries out its measurement and evaluation functions and provides output signals according to the set parameters.

Operation indication → 7 Operating and display elements.

10.1 Read set parameters

- ▶ Press [●].
- ▶ Press [▲] or [▼] until the requested parameter is displayed.
- ▶ Briefly press [●].
- > The unit displays the corresponding parameter value for approx. 30 s; then it changes to the process value display.

10.2 Self-diagnosis / error indications

The unit has many self-diagnostic options.

- It monitors itself automatically during operation.
- Warnings and faults are displayed (even if the display is deactivated), in addition they are available via the parameter setting software.

Display	Status LED OUT1	Status LED OUT2	Type of fault *)	Fault / warning	Corrective measures
none			F	Supply voltage too low.	▶ Check / correct the supply voltage.
SC flashes	flashes	flashes	F	Excessive current at switching outputs OUT1 and OUT2 **).	▶ Check switching outputs for short-circuit or excessive current; remove the fault.
SC1 flashes	flashes		F	Excessive current at switching output OUT1 **).	▶ Check switching output OUT1 for short-circuit or excessive current; remove the fault.
SC2 flashes		flashes	F	Excessive current at switching output OUT2 **).	▶ Check switching output OUT2 for short-circuit or excessive current; remove the fault.
Loc			W	Parametrierung über Tasten gesperrt.	▶ Unlock buttons → 9.1 Parameter setting in general → "Locking / unlocking".
C.Loc			W	Parameter setting locked via pushbuttons, parameter setting is active via IO-Link communication → 9.1.	▶ Wait until parameter setting via IO-Link is finished.
S.Loc			W	Setting buttons locked via parameter software. Parameter change is rejected → 9.1.	▶ Unlocking only possible via IO-Link interface / parameter setting software.

Display	Status LED OUT1	Status LED OUT2	Type of fault *)	Fault / warning	Corrective measures
OL			W	Process value too high (measuring range exceeded).	▶ Check / reduce system pressure / select unit with corresponding measuring range.
UL			W	Process value too low (value below measuring range).	▶ Check / increase system pressure / select unit with corresponding measuring range.
Err flashes			F	Internal fault / malfunction.	▶ Contact the manufacturer.

*) F = fault

W = warning

***) The output remains deactivated as long as the excessive current / short circuit continues.

11 Technical data and scale drawing

11.1 Setting ranges

		SP		rP		ASP2		AEP2		cFH		cFL		ΔP
		min	max	min	max	min	max	min	max	min	max	min	max	
PN2270 PN2670	psi	40	5800	10	5780	0	4640	1160	5800	20	5800	0	5780	10
	bar	2.5	400	1	398.5	0	320	80	400	1.5	400	0	398.5	0.5
	MPa	0.25	40	0.1	39.85	0	32	8	40	0.15	40	0.0	39.85	0.05
PN2271 PN2671	psi	25	3625	10	3610	0	2900	725	3625	15	3625	0	3610	5
	bar	1.5	250	0.5	249	0	200	50	250	1	250	0	249	0.5
	MPa	0.15	25	0.05	24.9	0	20	5	25	0.1	25	0.0	24.9	0.05

ΔP = Schrittweite

		SP		rP		ASP2		AEP2		cFH		cFL		ΔP
		min	max	min	max	min	max	min	max	min	max	min	max	
PN2292 PN2692	psi	10	1450	4	1444	0	1160	290	1450	6	1450	0	1444	2
	bar	0.6	100	0.2	99.6	0	80	20	100	0.4	100	0	99.6	0.2
	MPa	0.06	10	0.02	9.96	0	8	2	10	0.04	10	0	9.96	0.02
PN2293 PN2693	psi	-12	362.5	-13.5	361	-14.5	290	58	362.5	-13	362.5	-14.5	361	0.5
	bar	-0.85	25	-0.95	24.9	-1	20	4	25	-0.9	25	-1	24.9	0.05
	MPa	-0.085	2.5	-0.095	2.49	-0.1	2	0.4	2.5	-0.09	2.5	-0.1	2.49	0.005
PN2294 PN2694	psi	-13.6	145	-14.2	144.4	-14.6	116	14.6	145	-13.8	145	-14.6	144.4	0.2
	bar	-0.94	10	-0.98	9.96	-1	8	1	10	-0.96	10	-1	9.96	0.02
	MPa	-0.094	1	-0.098	0.996	-0.1	0.8	0.1	1	-0.096	1	-0.1	0.996	0.002
PN2296 PN2696	psi	-1.6	36.25	-1.75	36.1	-1.8	29	5.45	36.25	-1.65	36.25	-1.8	36.1	0.05
	bar	-0.11	2.5	-0.12	2.49	-0.125	2	0.375	2.5	-0.115	2.5	-0.125	2.49	0.005
	kPa	-11	250	-12	249	-12.5	200	37.5	250	-11.5	250	-12.5	249	0.5
PN2297 PN2697	psi	-0.64	14.5	-0.7	14.44	-0.72	11.6	2.18	14.5	-0.66	14.5	-0.72	14.44	0.02
	mbar	-44	1000	-48	996	-50	800	150	1000	-46	1000	-50	996	2
	kPa	-4.4	100	-4.8	99.6	-5	80	15	100	-4.6	100	-5	99.6	0.2
	inH2O	-17.5	401.5	-19	400	-20	321	60.5	401.5	-18.5	401.5	-20	400	0.5

ΔP = Schrittweite

		SP		rP		ASP2		AEP2		cFH		cFL		ΔP
		min	max	min	max	min	max	min	max	min	max	min	max	
PN2299 PN2699	psi	-14.3	14.5	-14.45	14.4	-14.5	8.7	-8.7	14.5	-14.4	14.5	-14.5	14.4	0.05
	mbar	-985	1000	-995	990	-1000	600	-600	1000	-990	1000	-1000	990	5
	kPa	-98.5	100	-99.5	99	-100	60	-60	100	-99	100	-100	99	0.5
	inH ₂ O	-396	402	-400	398	-402	240	-240	402	-398	402	-402	398	2
	inHg	-29.2	29.5	-29.4	29.3	-29.5	17.7	-17.7	29.5	-29.3	29.5	-29.5	29.3	0.1
PN2298 PN2698	inH ₂ O	-4.4	100.4	-4.8	100	-5	80.2	15	100.4	-4.6	100.4	-5	100	0.2
	mbar	-11	250	-12	249	-12.5	200	37.5	250	-11.5	250	-12.5	249	0.5
	mmWS	-110	2550	-120	2540	-125	2040	385	2550	-115	2550	-125	2540	5
	kPa	-1.1	25	-1.2	24.9	-1.25	20	3.75	25	-1.15	25	-1.25	24.9	0.05

UK

ΔP = Schrittweite

11.2 Further technical data



Further technical data and scale drawing at:

www.ifm.com

12 Factory setting

	Factory setting	User setting
SP1	25% MEW***	
rP1	23% MEW***	
ou1	Hno	
ou2	I	
SP2	75% MEW***	
rP2	73% MEW***	
ASP2	0 (PN2x99: -14,4 psi) (PN2x69: -7,3 psi)	
AEP2	100% MEW *	
coF	0	
dSx	0.0	
drx	0.0	
P-n	PnP	
dAP	0.06	
dAA	0.1	
diS	d2	
uni	PSI / IH2O	
coLr	rEd	
cFH	VMR*	
cFL	MAW**	

* = Final value of the measuring range (MEW)

** = Initial value of the measuring range (MAW)

*** = The indicated percentage of the final value of the measuring range (VMR) of the respective sensor in psi (for PN2x69 and PN2x99 the percentage of the measuring span) is set.

More information at www.ifm.com

