

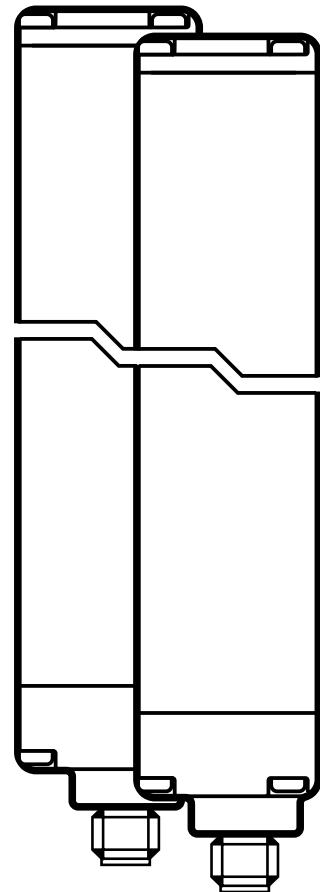

Original operating instructions
Photoelectric safety sensors
(safety light curtain / safety light grid)
Protected area width (range) 0...12 m
OY

UK

704555 / 05 02 / 2018



Contents

1	Preliminary note.....	4
1.1	Symbols used	4
1.2	Warning signs used	4
2	Safety instructions	5
2.1	Safety-related requirements regarding the application.....	6
3	Items supplied.....	7
4	Functions and features	7
5	Function	8
6	Installation.....	9
6.1	Installation instructions	9
6.2	Calculation of the minimum safety distance	10
6.3	Vertical installation of the safety light curtains / light grids.....	12
6.3.1	Safety light curtains resolutions 30 mm and 40 mm	12
6.3.2	Safety light curtains resolutions 50 mm and 90 mm, safety light grids 2, 3 and 4 beams.....	13
6.4	Horizontal installation of the safety light curtains.....	14
6.5	Fixing and optical alignment	14
6.5.1	Optical alignment.....	15
6.6	Distance of the reflecting surfaces	16
6.7	Multiple systems	18
6.8	Use of corner mirrors.....	19
7	Electrical connection.....	20
7.1	Wiring diagram transmitter.....	20
7.1.1	Configuration protected area width (range).....	20
7.2	Wiring diagram receiver.....	21
8	Operating modes	22
8.1	Automatic operation	23
8.2	Manual operation	23
8.3	Connection of external contactors K1 and K2	24
8.4	Test function.....	24
8.4.1	Internal test function	24
9	Operating and display elements	25

9.1 LED states	25
10 Operation	26
10.1 Switching state of the outputs	26
10.1.1 The safe state	26
10.1.2 The switched state	26
10.1.3 Interface classification	27
10.2 Functional test of the safety light curtains / light grids	27
11 Scale drawing	28
11.1 safety light curtain	28
11.2 safety light grid	29
12 Technical data	30
12.1 Safety light curtains / light grids type 2	30
12.1.1 Safety light curtains: 30 mm resolution	31
12.1.2 Safety light curtains: 40 mm resolution	31
12.1.3 Safety light curtains: 50 mm resolution	31
12.1.4 Safety light curtains: 90 mm resolution	32
12.1.5 Safety light grids 2, 3 and 4 beams	32
12.2 Safety light curtains / light grids type 4	33
12.2.1 Safety light curtains: 30 mm resolution	34
12.2.2 Safety light curtains: 40 mm resolution	34
12.2.3 Safety light curtains: 50 mm resolution	34
12.2.4 Safety light curtains: 90 mm resolution	35
12.2.5 Safety light grids 2, 3 and 4 beams	35
13 Troubleshooting	36
13.1 Fault diagnosis transmitter	36
13.2 Fault diagnosis receiver	37
14 Maintenance, repair and disposal	38
15 Terms and abbreviations	39
16 Annex	40
16.1 Check list	40

1 Preliminary note

The instructions are part of the unit. They are intended for authorised persons according to the EMC and low voltage directives and safety regulations.

The instructions contain information about the correct handling of the product.

Read the instructions before use to familiarise yourself with operating conditions, installation and operation.

Adhere to the safety instructions.

1.1 Symbols used

▶ Instruction

> Reaction, result

[...] Designation of pushbuttons, buttons or indications

→ Cross-reference



Important note:

Non-respect can result in malfunctions or interference.



Information

Supplementary note.



Access prevention hand protection



Access prevention bodies or parts of bodies



Primary guarding bodies or parts of bodies



Access prevention body protection

1.2 Warning signs used

 **WARNING**

Warning of serious personal injury.

Death or serious irreversible injuries may result.

2 Safety instructions

- Follow the operating instructions.
- In case of non-observance of notes or standards, specially when tampering with and/or modifying the unit, any liability and warranty is excluded.
- The unit must be installed, connected and put into operation by a qualified electrician trained in safety technology.
- The applicable technical standards for the corresponding application must be complied with.
- For the installation the standards EN 60204 and ISO 13855 have to be observed.
- In case of malfunction of the unit please contact the manufacturer. Tampering with the unit is not allowed.
- Disconnect the unit externally before handling it. Disconnect all relay load circuits that are supplied independently.
- After setup the system has to be subjected to a complete function check.
- Only use the unit under the specified operating conditions (→ 12 Technical data). In case of special operating conditions please contact the manufacturer.
- In case of any questions concerning safety - if required - contact the safety expert in charge of your country.

UK

WARNING

In case of improper handling of the product, the safety and physical integrity of operators and machinery cannot be guaranteed.

Death or serious irreversible injuries may result.

- ▶ Observe all notes on installation and handling in these instructions.
- ▶ The photoelectric safety sensors must only be used under the specified operating conditions and in accordance with use as prescribed below.

2.1 Safety-related requirements regarding the application

It must be ensured that the safety requirements of the respective application correspond to the requirements stated in these instructions.

Observe the following requirements:

- ▶ Adhere to the specified operating conditions (→ 12 Technical data). Use of the photoelectric safety sensors in the vicinity of chemically and biologically active media as well as ionising radiation is not permitted.
- ▶ For applications in the food industry contact your ifm branch office to check the compatibility of the materials of the photoelectric safety sensors with the chemicals used.
- ▶ Adhere to the principle of normally closed operation for all external safety circuits connected to the system.
- ▶ If the photoelectric safety sensors go into the state defined as safe due to an internal fault, measures have to be taken to maintain the safe state when the installation resumes operation.
- ▶ Replace damaged units.

The protective function of the photoelectric safety sensors is only ensured with the following conditions:

- The machine control can be electrically controlled and the hazardous machine motion can be stopped immediately at any time of the operation cycle.
- There is no danger for machine operators due to ejection of materials or machine parts.
- The hazardous area is only accessible via the protected area.

3 Items supplied

- 2 photoelectric safety sensors (1 transmitter and 1 receiver)
- up to a total length of 1263 mm: 4 angle brackets, 4 slot nuts with M5 thread and suitable nuts
- starting with 1263 mm total length: 6 angle brackets, 6 slot nuts with M5 thread and suitable nuts
- 1 copy operating instructions photoelectric safety sensors, reference no. 704555.

If one of the above-mentioned components is missing or damaged, please contact **UK** one of the ifm branch offices.

4 Functions and features

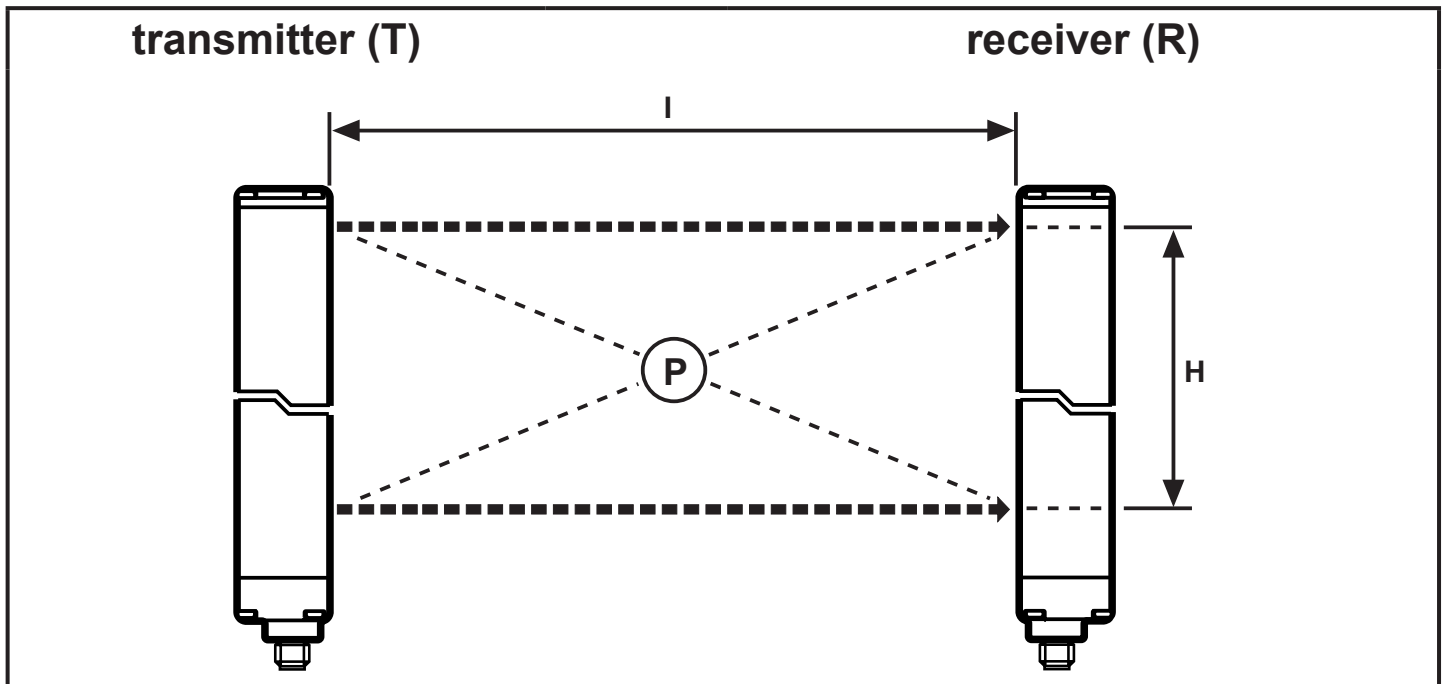

P = protected area; l = protected area width (range) H = protected area height

The OY safety light curtains / light grids are multi-beam optoelectronic safety devices to IEC 61496 and consist of one transmitter and one receiver.

5 Function

The protected area (P) is generated between the transmitter and the receiver and is defined by the protected area height (H) and the protected area width (range) (l).

The protected area height is the height protected by the safety light curtain / safety light grid. It depends on the design (→ 12 Technical data).

If the safety light curtains / light grids are installed horizontally, this value indicates the depth of the protected area.

The protected area width (range) is the maximum distance between transmitter and receiver (→ 12 Technical data).

If the protected area is clear, the two outputs (OSSDs) of the receiver are active.

If an object (O) with a diameter greater than or equal to the resolution (d) enters the protected area, the outputs are switched off.

The resolution (d) (detection capability) of the safety light curtain / light grid depends on the lens diameter (B) and the lens distance (C) and remains constant at all application conditions.

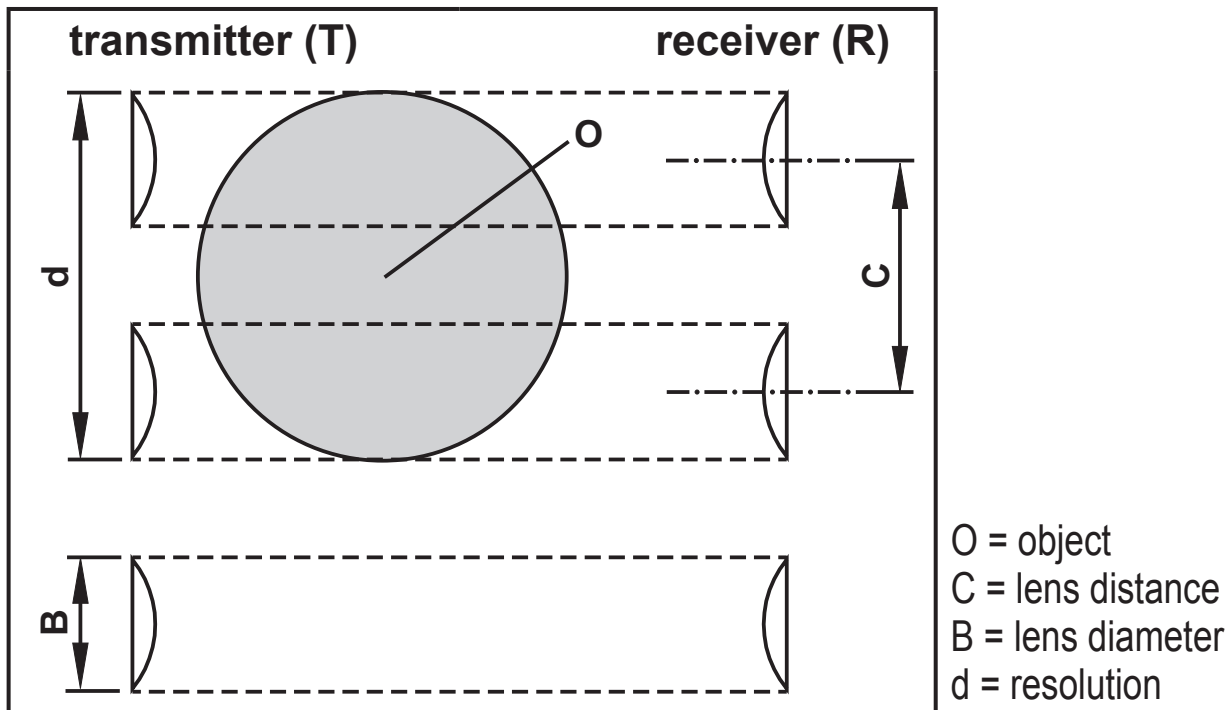

To ensure that an object (O) is reliably detected in the protected area the dimensions of the object (O) must be at least as great as the resolution (d).

6 Installation

6.1 Installation instructions

The following conditions are to be ensured before installation of the photoelectric safety sensors:

- The degree of protection of the electro-sensitive equipment (ESPE) has to correspond with the risk assessment of the machine to be monitored.
- The safety system ensures a safety function and is not required for the operation of a machine.
- It must be possible to stop any hazardous motion of the machine immediately. In this respect the shutdown delay of the machine has to be determined.
- The object to be detected must be greater than or equal to the resolution of the photoelectric safety sensor.



Install the photoelectric safety sensors so that the hazardous area can only be accessed via the protected area. Depending on the application other mechanical protective equipment may be necessary.

The operating conditions at the mounting location must not affect the functioning of the photoelectric safety sensors. Please note especially:

- The transmitter and the receiver must not be affected by intensive light sources (emitters, sunlight etc.).
- The operating temperature must be within the range indicated (→ 12 Technical data).
- Fogging of the lenses due to considerable temperature fluctuations can affect the functioning of the photoelectric safety sensors. Take appropriate measures to prevent this.
- Certain operating conditions can affect the functioning of the photoelectric safety sensors. For mounting locations where fog, rain, smoke or dust may occur, it is recommended to take appropriate measures.
- The directive ISO 13855 must be observed.



Observe the following illustrations for correct installation of the photoelectric safety sensors.

Correct installation

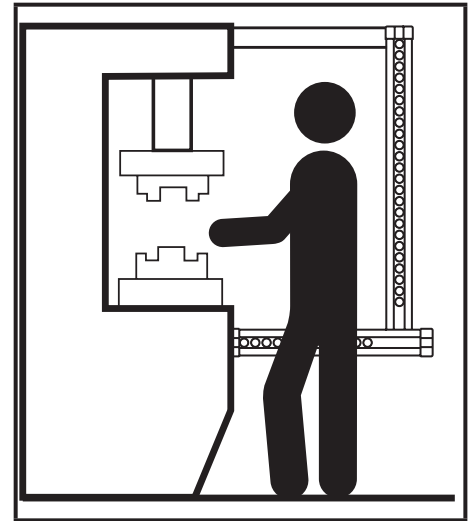
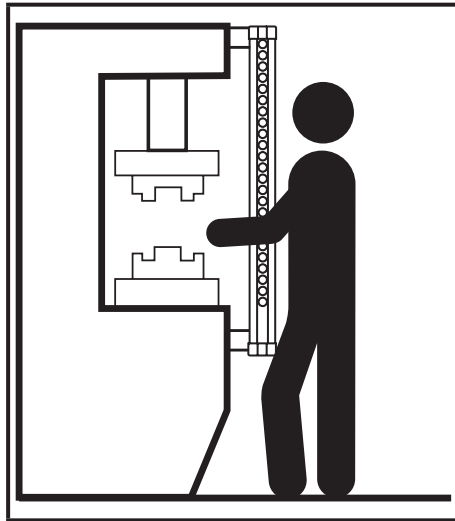
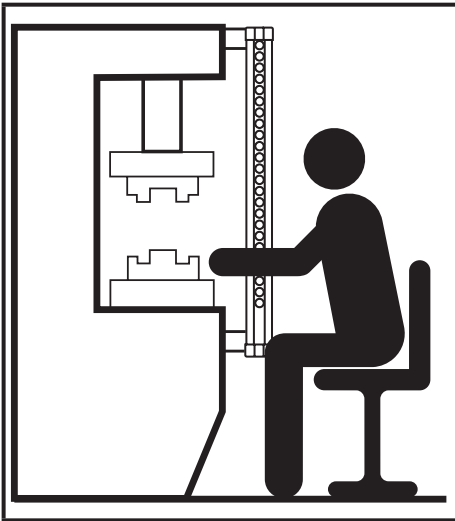

Wrong installation

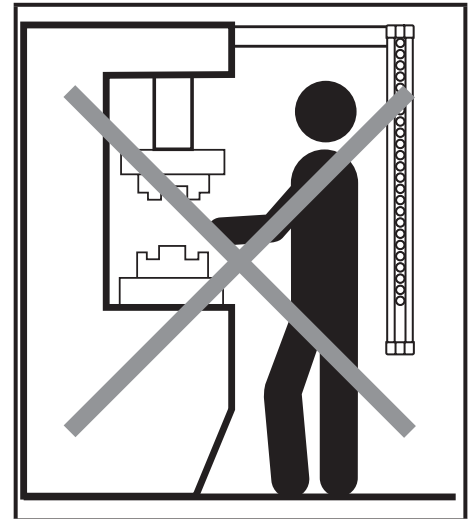
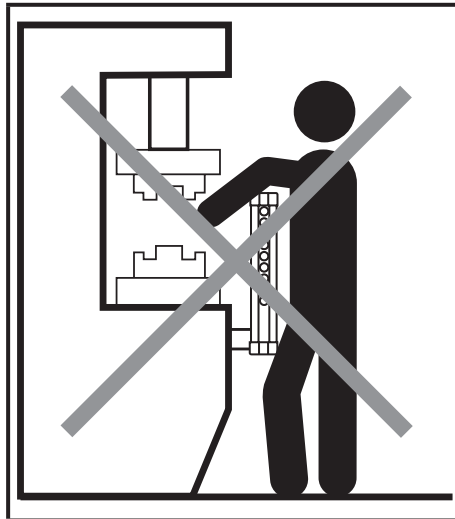
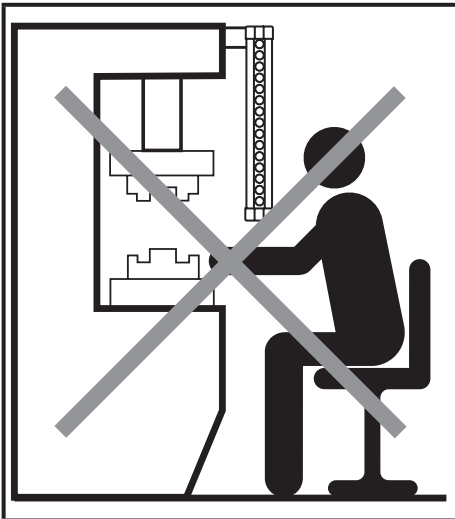

6.2 Calculation of the minimum safety distance

There must be minimum safety distance between the photoelectric safety sensor and the point of danger. This distance must be ensured so that the point of danger cannot be accessed before the hazardous state of the machine has been stopped.

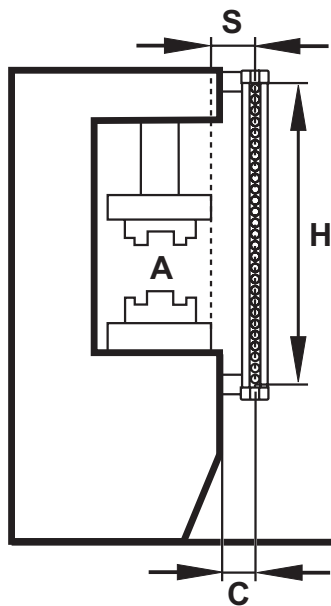

- ▶ Install the photoelectric safety sensor at a distance that is greater or equal to the minimum safety distance (S) so that the hazardous area (A) can only be accessed after complete standstill of the hazardous machine motion.

According to the European Standard ISO 13855 the following formula is to be used to calculate the minimum safety distance (S):

$$S = K(t_1 + t_2) + C$$

$$C = 8(d - 14)$$

A = hazardous area
H = protected area height

S = min. safety distance
C = additional distance

S	Minimum safety distance	mm
K	Speed of approach of the object towards the hazardous area	mm/s
t₁	Total response time of the protective equipment, from release to switching off	s
t₂	Total response time of the machine, from the stop signal to switching off or to passing into the state defined as safe	s
C	Additional distance	mm
d	Resolution (detection capability)	mm



Non-compliance with the minimum safety distance may lead to restrictions to or loss of the safety function.

Application example:

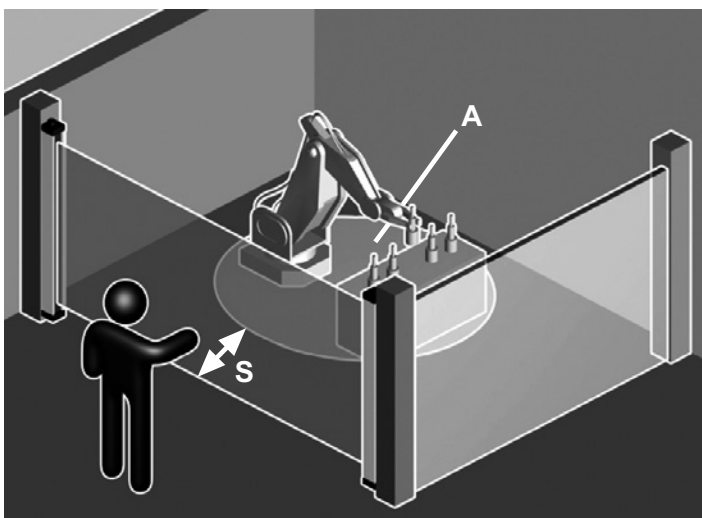

A = hazardous area
S = min. safety distance

6.3 Vertical installation of the safety light curtains / light grids

6.3.1 Safety light curtains resolutions 30 mm and 40 mm



These designs are suitable for access prevention of hands (hand protection).



They must not be used for finger protection!

The minimum safety distance (S) is determined using the following formula:

$$S = 2000 (t_1 + t_2) + 8 (d - 14)$$

This formula applies to minimum safety distances (S) between 100 and 500 mm. If the calculation shows that S is greater than 500 mm, the distance can be reduced to a minimum value of 500 mm by using the following formula:

$$S = 1600 (t_1 + t_2) + 8 (d - 14)$$

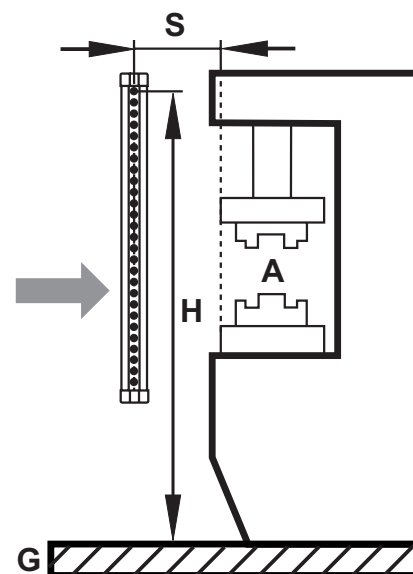

A = hazardous area

H = height

S = min. safety distance

G = reference level

If due to the special configuration of the machine it should be possible to reach the hazardous area from above, the highest light beam of the safety light curtain should be at a height (H) (measured from the reference level (G)) whose value is determined to the specifications in ISO 13855.

6.3.2 Safety light curtains resolutions 50 mm and 90 mm, safety light grids 2, 3 and 4 beams



These versions are suitable for access prevention for bodies or parts of bodies.



They must not be used for finger or hand protection!

The minimum safety distance (S) is determined using the following formula:

$$S = 1600 (t_1 + t_2) + 850$$

The height (H1) of the upper light beam measured from the reference level (G) must not be shorter than 900 mm while the height (H2) of the lowest light beam must not exceed 300 mm (ISO 13855).

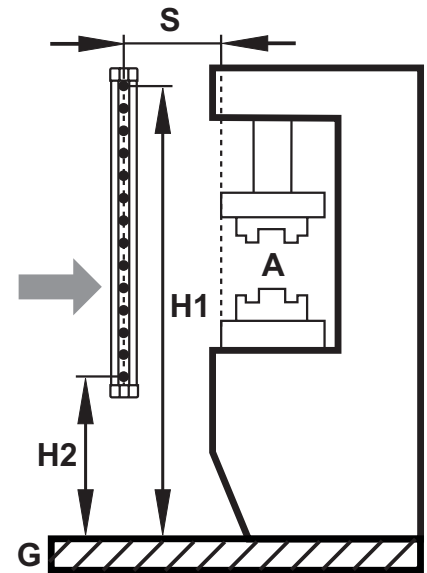

UK

A = hazardous area

Hx = height

S = min. safety distance

G = reference level

6.4 Horizontal installation of the safety light curtains



These versions are suitable for primary guarding for bodies or parts of bodies.

With horizontal installation it has to be noted that the distance between the outer border of the hazardous area (A) and the outer light beam of the safety light curtain is greater than or equal to the minimum safety distance (S). It is calculated as follows:

$$S = 1600 (t_1 + t_2) + 1200 - 0.4 H$$

with H being the height of the protected area of the reference level (G) of the machine;

$$H = 15 (d - 50)$$

In this example the following applies: $H < 1$ m (to ISO 13855).

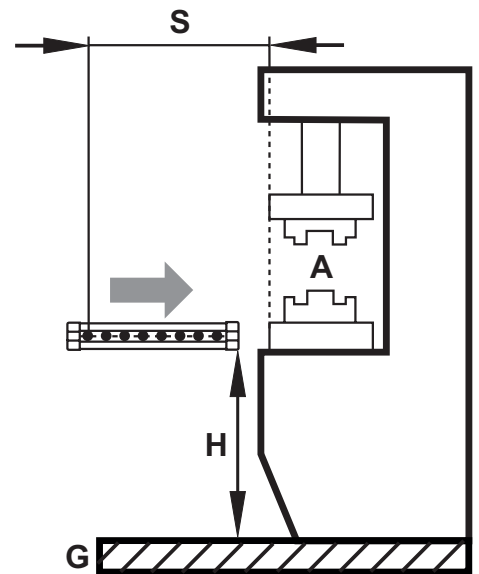

A = hazardous area
H = height

S = min. safety distance
G = reference level

6.5 Fixing and optical alignment



Correct alignment of the transmitter and the receiver is decisive for the proper function of the photoelectric safety sensors.

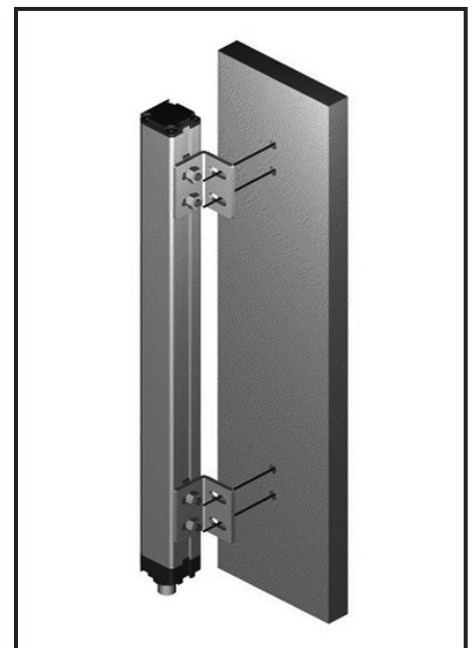
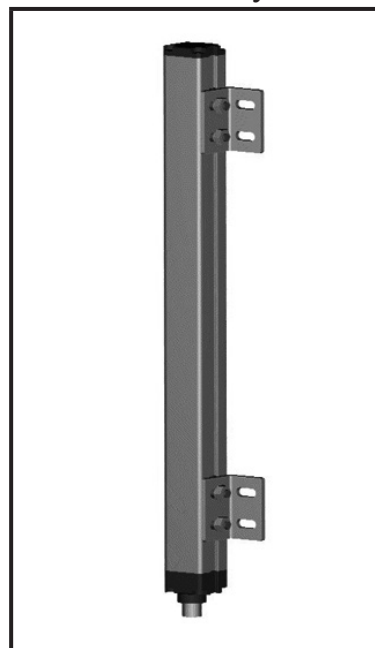
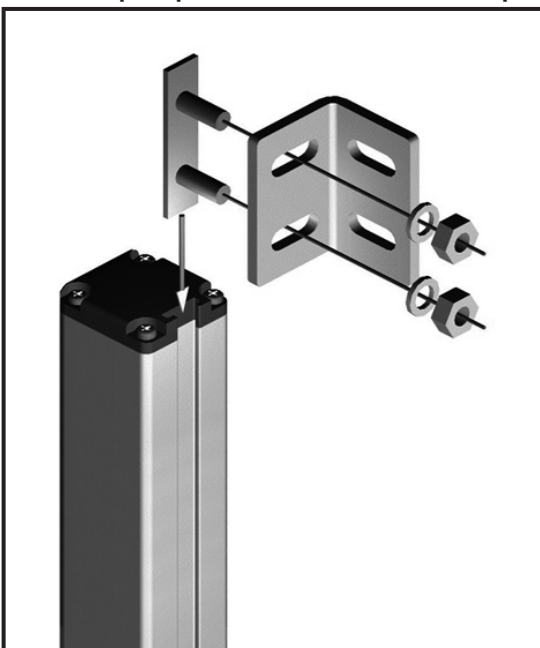

- ▶ Install the transmitter and the receiver using the supplied mounting accessories so that they are exactly opposite each other.
- ▶ Align the transmitter and the receiver so that they are in parallel at the same height and the plugs face the same direction.

 If vibrations are to be expected in your applications, it is recommended to use vibration dampers (available as accessory).

 Adjustable brackets can be used to ensure easy optical alignment (available as accessories).

6.5.1 Optical alignment

UK

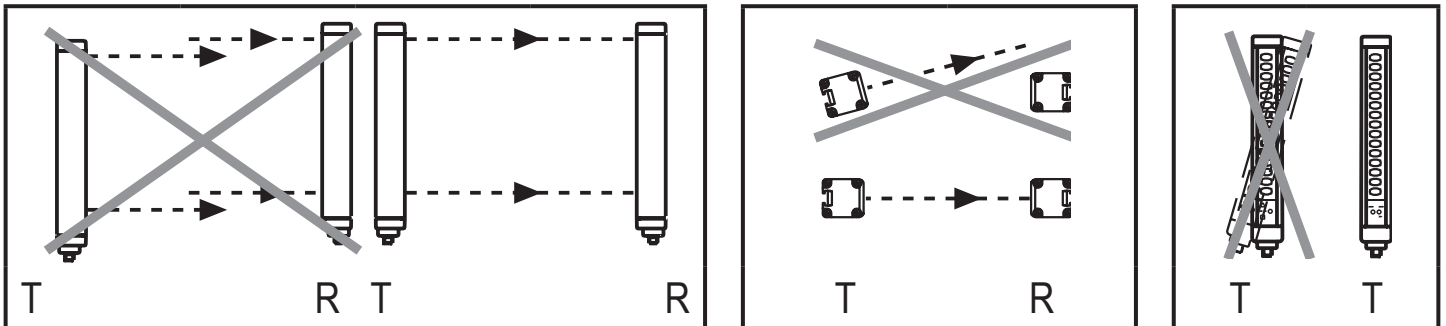

T = transmitter; R = receiver

The indication LEDs of the receiver help to correctly align the photoelectric safety sensors.

- ▶ Align the transmitter so that the green LED of the receiver lights.
- ▶ Fix the transmitter and the receiver.

6.6 Distance of the reflecting surfaces



Reflective surfaces close to photoelectric safety sensors can disable the safety function of the system.

The minimum distance (D) depends on the protective area width (I) taking into consideration the projection and receiving angles.



The minimum distance (D) between reflective surfaces and the protected area (P) must be observed. In case of non-respect an object to be detected may not be detected. In case of improper handling of the product, the safety and physical integrity of operators and machinery cannot be guaranteed.

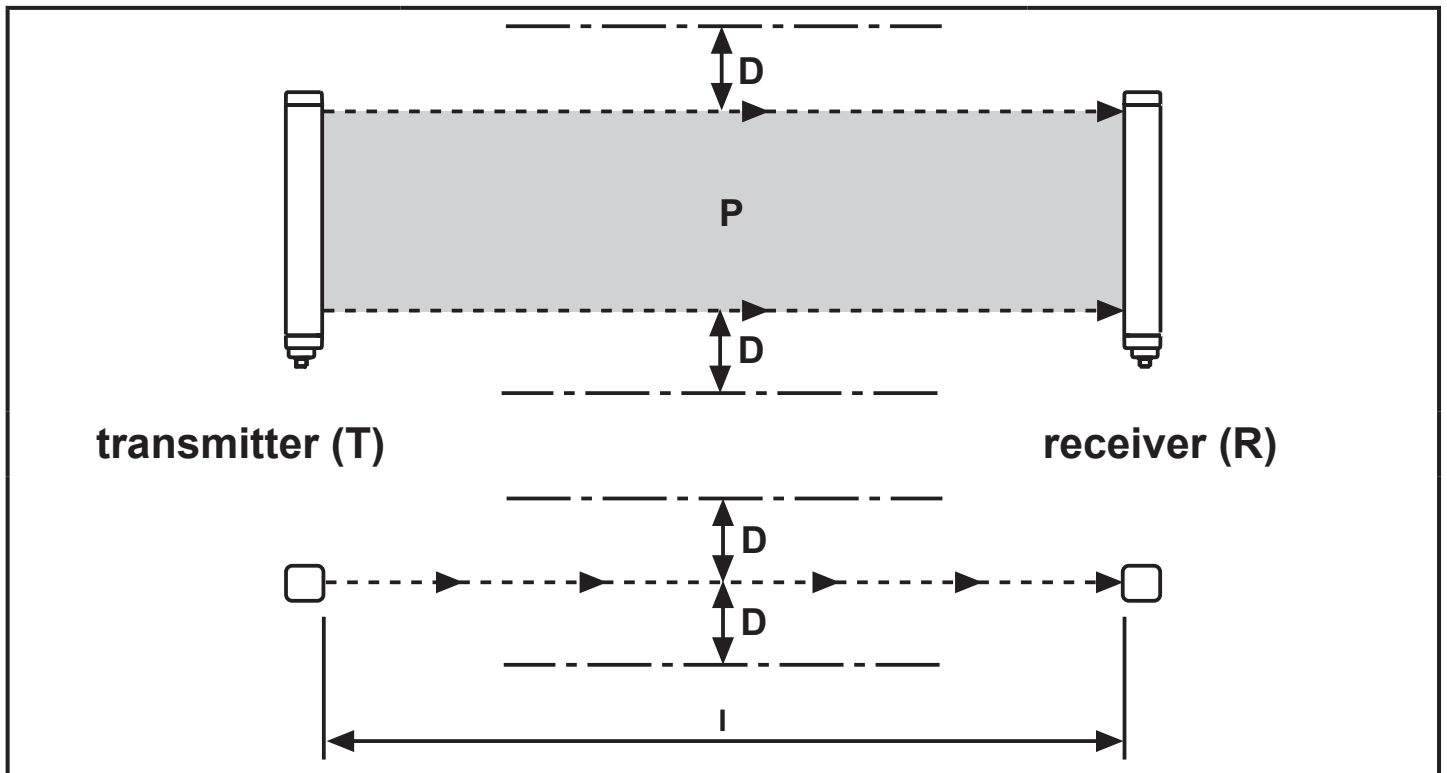

D = minimum distance; I = protected area width (range); P = protected area

- After installation test by intended interruption of the protected area (P) if reflective surfaces affect the function of the photoelectric safety sensors.

Minimum distance to reflective surfaces

Safety light curtains / light grids type 2

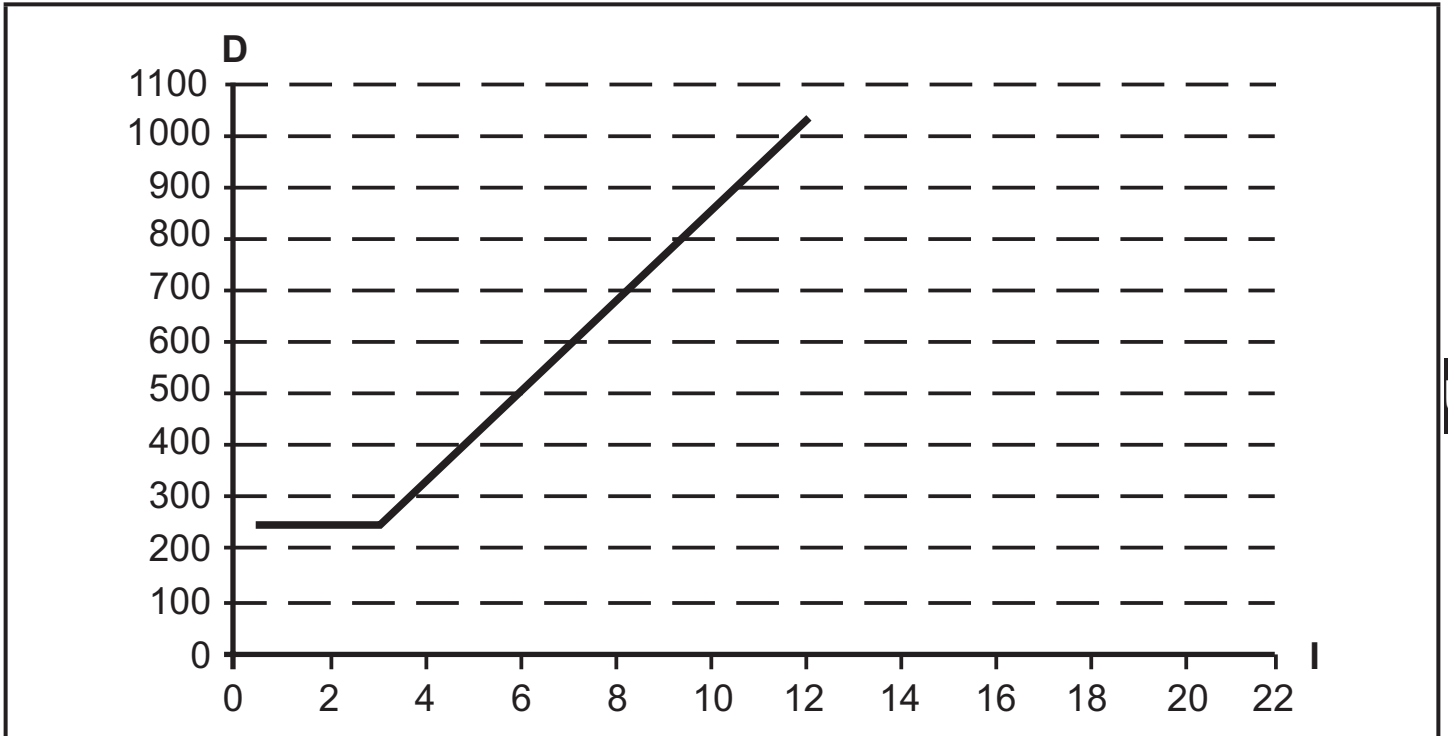

D = minimum distance in [mm]; I = protected area width (range) [m]

Safety light curtains / light grids type 4

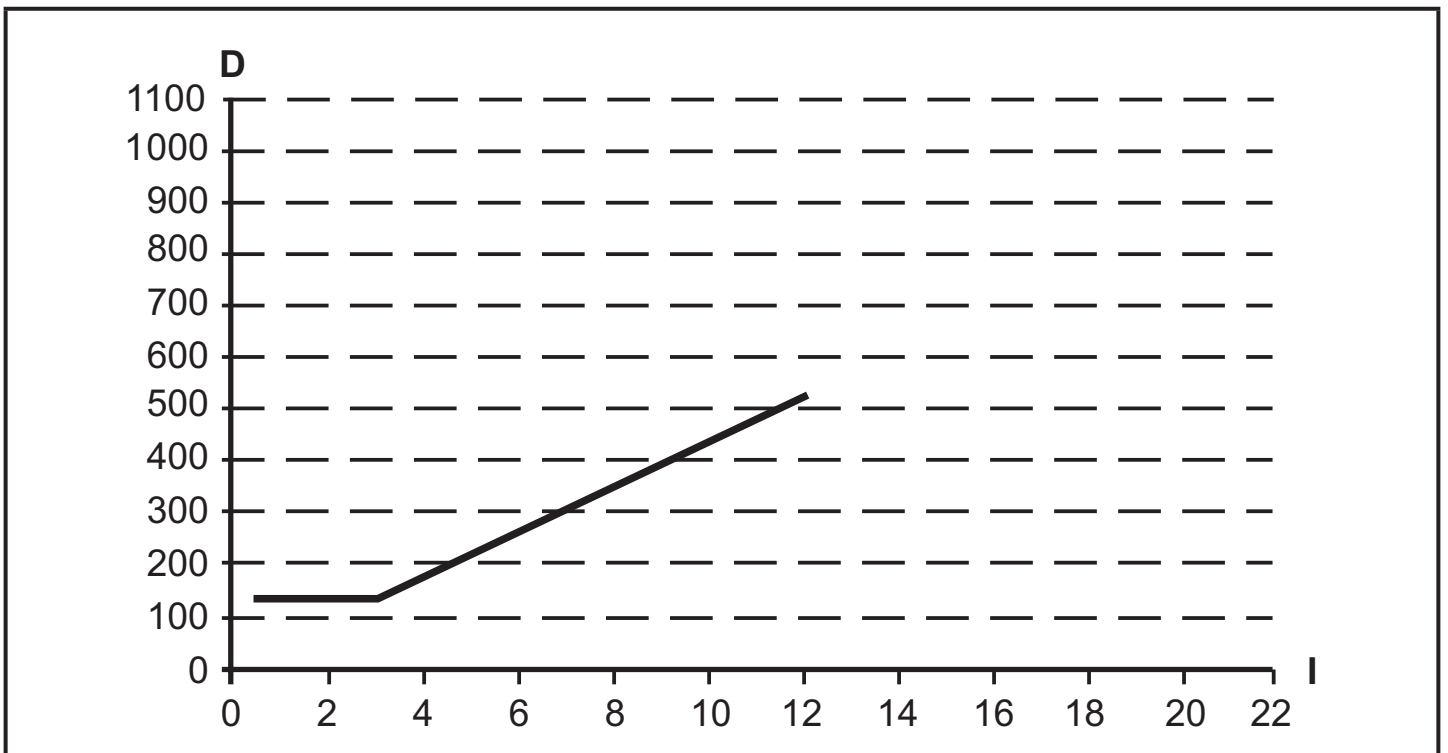

D = minimum distance in [mm]; I = protected area width (range) [m]

UK

6.7 Multiple systems



The use of several safety light curtains / light grids can lead to malfunction and disable the protective function.

The safety light curtains / light grids are to be installed so that the beam sent by the transmitter of a system can only be detected by the respective receiver.

The following important rules for installation are to be observed to avoid mutual interference of several systems:

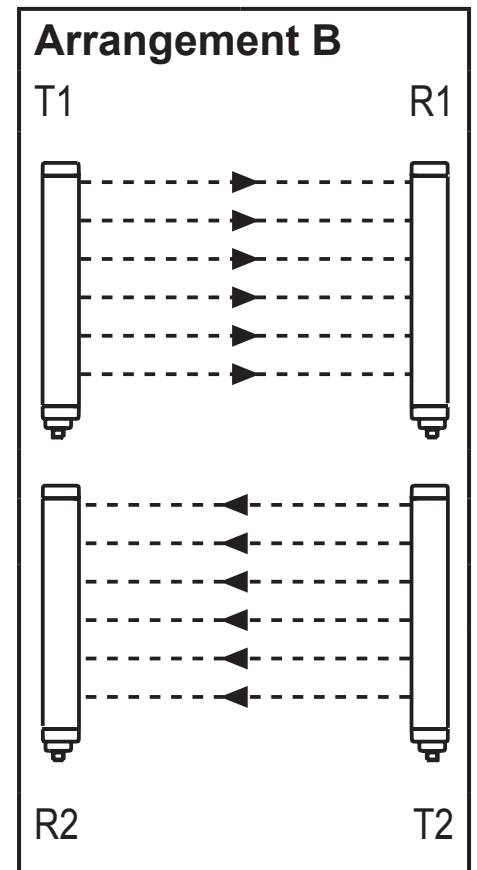
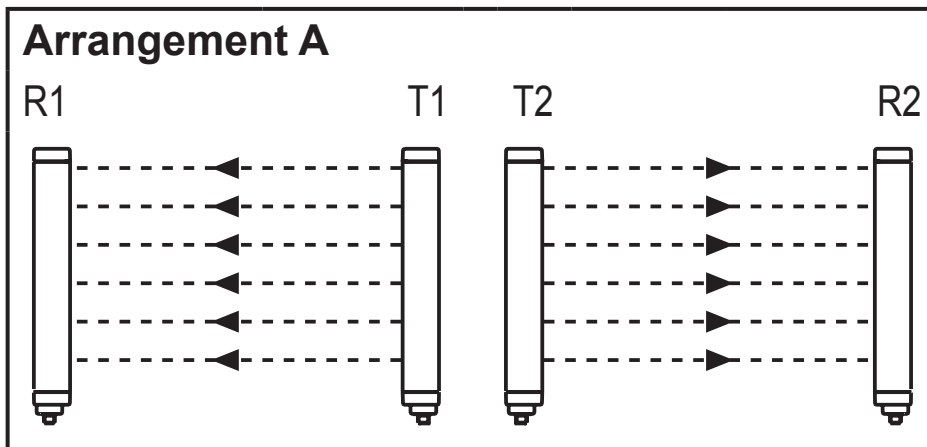

Possible arrangements:

A: Position of both transmitters next to each other

B: Position transmitter 1 and receiver 2 on top of each other

C: Combination in "L" shape

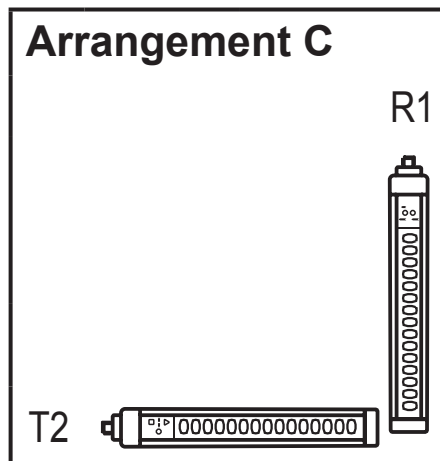

T = transmitter; R = receiver

6.8 Use of corner mirrors

To protect and monitor hazardous areas with access from several sides one or several mirrors can be used (available as accessory). By using mirrors the light beam emitted by the transmitter can be sent via several access sides.

- ▶ To obtain a reflection angle of 90° the mirrors are to be oriented in an angle of inclination of 45° .

The following image shows an application where U-shaped access protection is implemented using two mirrors.

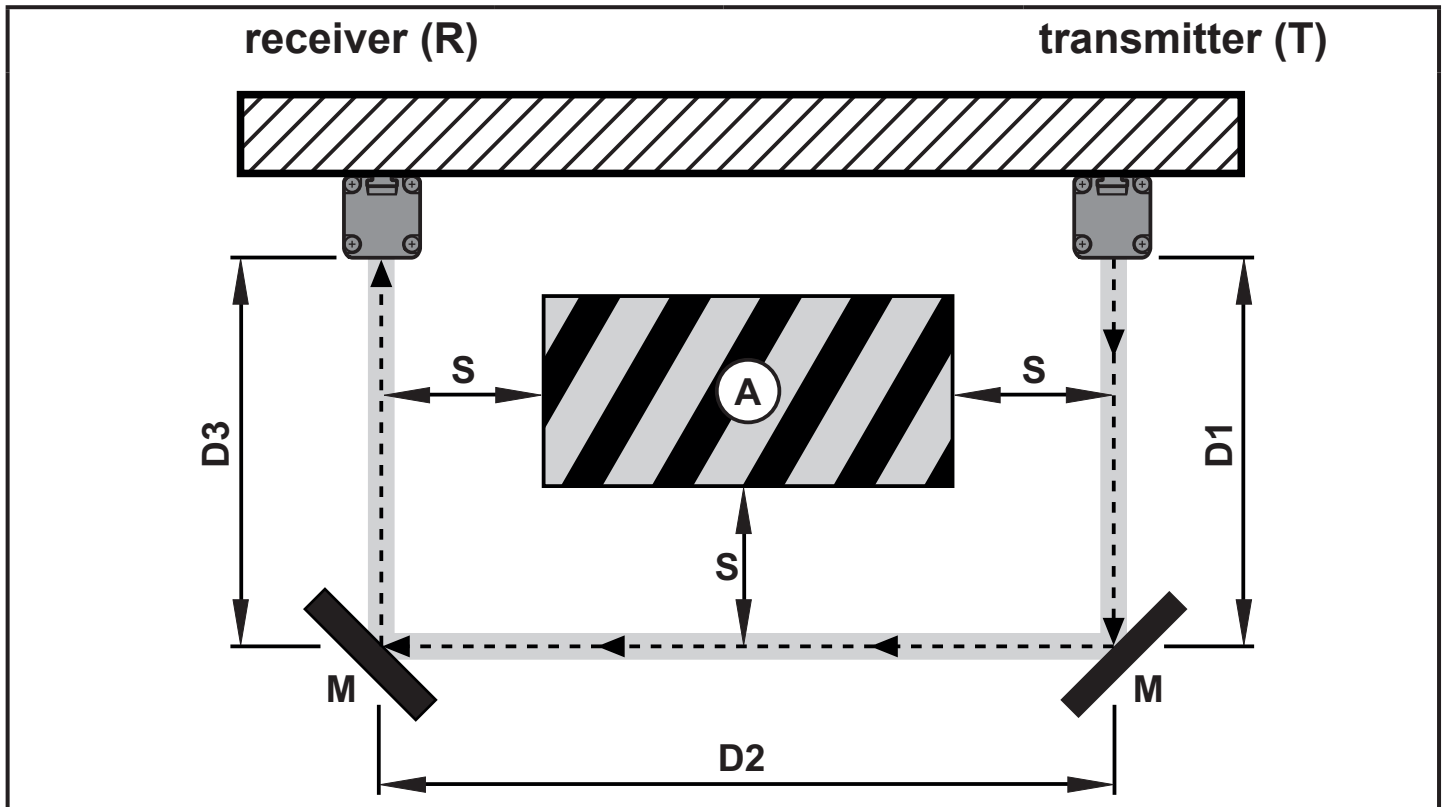

A = hazardous area
M = corner mirror

S = min. safety distance
Dx = side length

- ▶ Install the mirrors so that the minimum safety distance (S) is adhered to at each side of the hazardous area.
- ▶ During installation make sure that the reflecting area is plane and that no vibrations affect the safety device.
- The range is the sum of the length of all sides ($D1 + D2 + D3$) of the access to the protected area. The maximum range of the photoelectric safety sensors is reduced by 15% for each mirror.
- Do not use more than three mirrors.

7 Electrical connection

► Disconnect power. Also disconnect any independently supplied relay load circuits.

 The nominal voltage is 24 V DC. This voltage may vary between 19.2 V and 28.8 V.

 In case of a single fault the supply voltage must not exceed a maximum of 28.8 V DC. Therefore a safe separation between current supply and transformer is necessary.

 To guarantee functional reliability an output capacity of min. 2000 μ F / A has to be ensured if a power supply with diode bridge is used.

► Connect the devices to the following table:

7.1 Wiring diagram transmitter

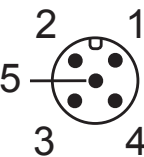
Pin layout	Pin	Name	Type	Description
	1	L+ (24 V DC)	Input	Operating voltage
	2	Range 0		Configuration protected area width
	3	L- (0 V DC)		Operating voltage
	4	Range 1		Configuration protected area width
	5	FE		Functional earth

For information about available sockets/connectors see:

www.ifm.com → Products → Accessories

The protected area width (range) to be used is configured via range 0 and range 1.

7.1.1 Configuration protected area width (range)

Range 0	Range 1	Description
24 V	0 V	Selection range low (0...4 m)
0 V	24 V	Selection range high (3...12 m)
0 V	0 V	Transmitter in test function (→ 8.4 Test function)
24 V	24 V	No function, configuration error

 For proper function of the safety light curtains / light grids pins 2 and 4 of the transmitter have to be connected according to the indications in the above table.

7.2 Wiring diagram receiver

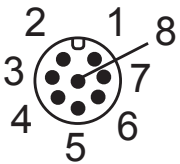
Pin layout	Pin	Name	Type	Description
	1	OSSD1	Output	Static safety output 1
	2	24 V DC	–	Operating voltage 24 V DC
	3	OSSD2	Output	Static safety output 2
	4	K1_K2 /restart	Input	External feedback contact
	5	SEL_A	Input	Operating mode Safety light curtains / light grids
	6	SEL_B	Input	
	7	0 V DC	–	Operating voltage 0 V DC
	8	FE	–	Functional earth

For information about available sockets/connectors see:

www.ifm.com → Products → Accessories



Note: Lay the cables of the photoelectric safety sensors separately from sources of interference such as power lines.

► Connect the transmitter and the receiver to the functional earth.

UK

8 Operating modes

The different operating modes of the safety light curtains / light grids of the OY series can be set via the respective connections to the 8-pole plug of the receiver.

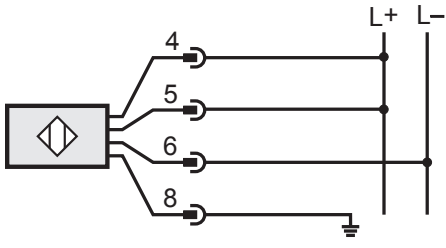
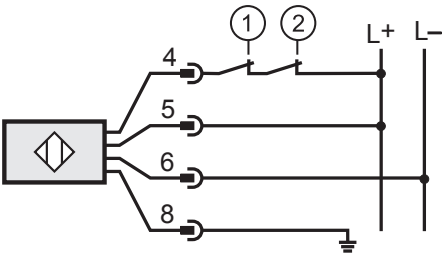
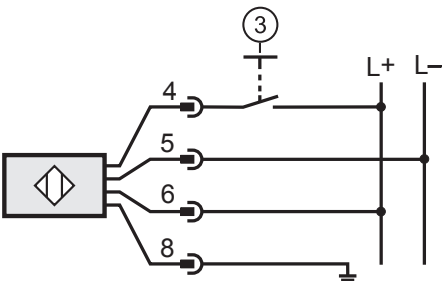
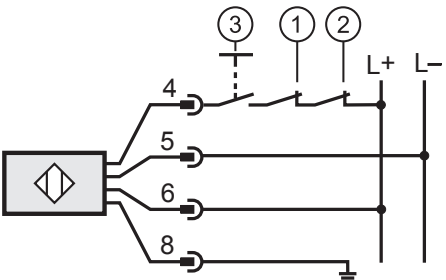
Operating modes	Connections		
	pin 4	pin 5	pin 6
A Automatic 	K1_K2 /restart Connects to: L+ (24 V DC)	SEL_A Connects to: L+ (24 V DC)	SEL_B Connects to: L- (0 V DC)
B Automatic with monitoring K1_K2 	K1_K2 /restart Connects to: L+ (24 V DC) (via NC contacts of K1_K2)	SEL_A Connects to: L+ (24 V DC)	SEL_B Connects to: L- (0 V DC)
C Manual 	K1_K2 /restart Connects to: L+ (24 V DC) (via start button)	SEL_A Connects to: L- (0 V DC)	SEL_B Connects to: L+ (24 V DC)
D Manually with monitoring K1_K2 	K1_K2 /restart Connects to: L+ (24 V DC) (via start button and NC contacts of K1_K2)	SEL_A Connects to: L- (0 V DC)	SEL_B Connects to: L+ (24 V DC)

- 1: K1
- 2: K2
- 3: Restart

8.1 Automatic operation

If the safety light curtains / light grids are used in the automatic mode, monitored start is not possible.

The safety light curtains / light grids automatically return to operation with clear protected area, the outputs (OSSDs) are activated.



Verify if this is compatible with your machine.

In the automatic mode the OSSD1 and OSSD2 outputs follow the status of the safety light curtains / light grids:

UK

Protected area clear	Outputs = active logic "1"
Protected area interrupted	Outputs = deactivated logic "0"

8.2 Manual operation

Operation in the manual mode (Start/Restart Interlock activated) is always necessary when passage to a hazardous area is to be monitored (persons can be present in the hazardous area after accessing the protected area without being detected).

The start/restart button has to be outside the hazardous area. It has to be installed so that the hazardous area and access can be clearly seen. It must not be possible to activate the start/restart button from within the hazardous area.



In the manual mode the safety light curtains / light grids comply with the function as "trip device" to IEC 61496. Non-compliance with this standard can lead to a hazard for people.

The OSSD1 and OSSD2 safety outputs are activated when the protected area is clear and the restart command is entered via a start button or via a respective pulse on input K1_K2/restart pin 4.

If the safety light curtains / light grids are released by a person or an object, a restart command (24 V on pin 4) has to be released. Pulse duration > 100 ms.

8.3 Connection of external contactors K1 and K2

External contactors can be integrated in the automatic or manual operating mode. The contactors have to be connected in series between the supply voltage and pin 4 of the receiver (→ 8 Operating modes / table, fig. B).

With manual function a start button has additionally to be switched in series (→ 8 Operating modes / table, fig. D).

8.4 Test function

For the test function the photoelectric safety sensors can e.g. be tested by a process control system or a control module (→ 7.1 Table Configuration protected area width).

The test pulse interrupts the light emission by the transmitter and the outputs carry a 0 signal (→ 10.1 Switching states of the outputs).



The minimum duration of the test command is 4 ms.

8.4.1 Internal test function

Type 2 safety light curtains / light grids have an automatic internal test function to detect faults. An internal test is performed at an interval of ≤ 5 s and with each change from "protected area interrupted" to "protected area clear".

Type 4 safety light curtains / light grids continuously perform internal tests. The faults are detected within the response time of the respective model leading to switch-off (response times → 12 Technical data).

9 Operating and display elements

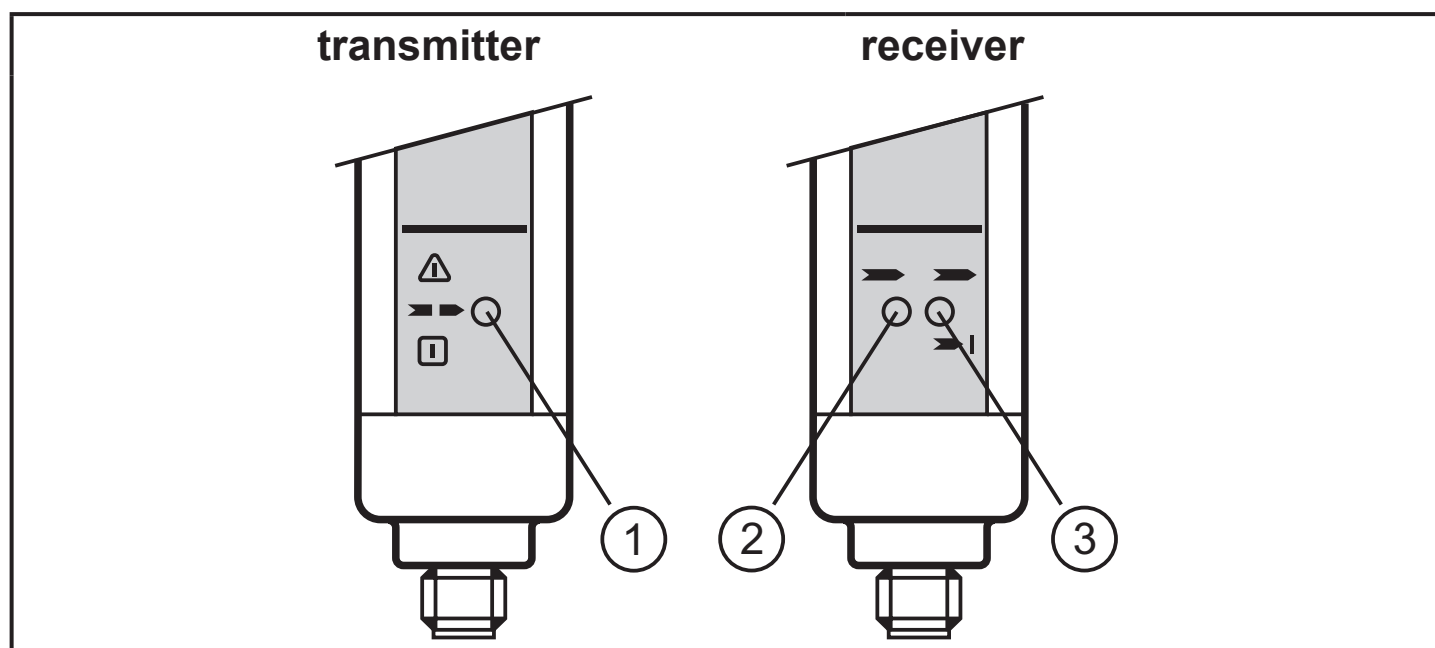

- 1: LED 3 colours (red/green/orange)
- 2: LED (yellow)
- 3: LED 2 colours (red/green)

9.1 LED states

Description	Transmitter 3-colour LED			Receiver 2-colour LED LED		
	red	green	orange	red	green	yellow
Activating the system, input test	●	○	○	●	○	●
Fault (→ 13 Troubleshooting)	⊗	○	○	⊗	○	○
Test condition	○	○	●	○	○	○
Normal operating conditions	○	●	○	○	●	○
Protected area interrupted, outputs deactivated	○	●	○	●	○	○
Protected area clear, outputs deactivated, waiting for restart	○	●	○	○	○	●
Protected area clear, outputs activated	○	●	○	○	●	○

10 Operation

10.1 Switching state of the outputs

The safety light curtains / light grids have two outputs (OSSDs) on the receiver; the status depends on the condition of the protected area.

All short-circuits between the outputs or between an output and the current supply (24 V DC or 0 V DC) are detected by the 1 safety light curtains / light grids as a fault.

Output	Binary states	Description
OSSD1	1	Condition protected area clear.
OSSD2	1	
OSSD1	1 0 0	Condition protected area interrupted or fault detected.
OSSD2	0 1 0	

10.1.1 The safe state

The safe state is when the output is switched off (zero-current state: logic "0") of min. one of the outputs (OSSDs).

If one of the outputs is switched off, the subsequent safety-related logic unit must bring the complete system into the state defined as safe.

10.1.2 The switched state

In switched state the receiver provides a current of 24 V DC (logic "1") to both outputs.

Output characteristics

The output characteristics follow the characteristics of the input according to IEC 61496:

Logic "1"	24 V DC	max. 400 mA
Logic "0"	≤ 1.5 V DC	< 0.2 mA

10.1.3 Interface classification

The interface of the devices complies with interface type C class 3 according to the ZVEI position paper CB 24I Ed. 2.0

Identification key

	Interface type		Suitable interface type		
Source	C3	Receiver	C1	C2	C3

10.2 Functional test of the safety light curtains / light grids



Check the proper function of the safety light curtains / light grids before work starts. **UK**

For the functional test a test object in accordance with a resolution of the safety light curtains / light grids has to be used.

For information about available test rods see:

www.ifm.com → Products → Accessories.

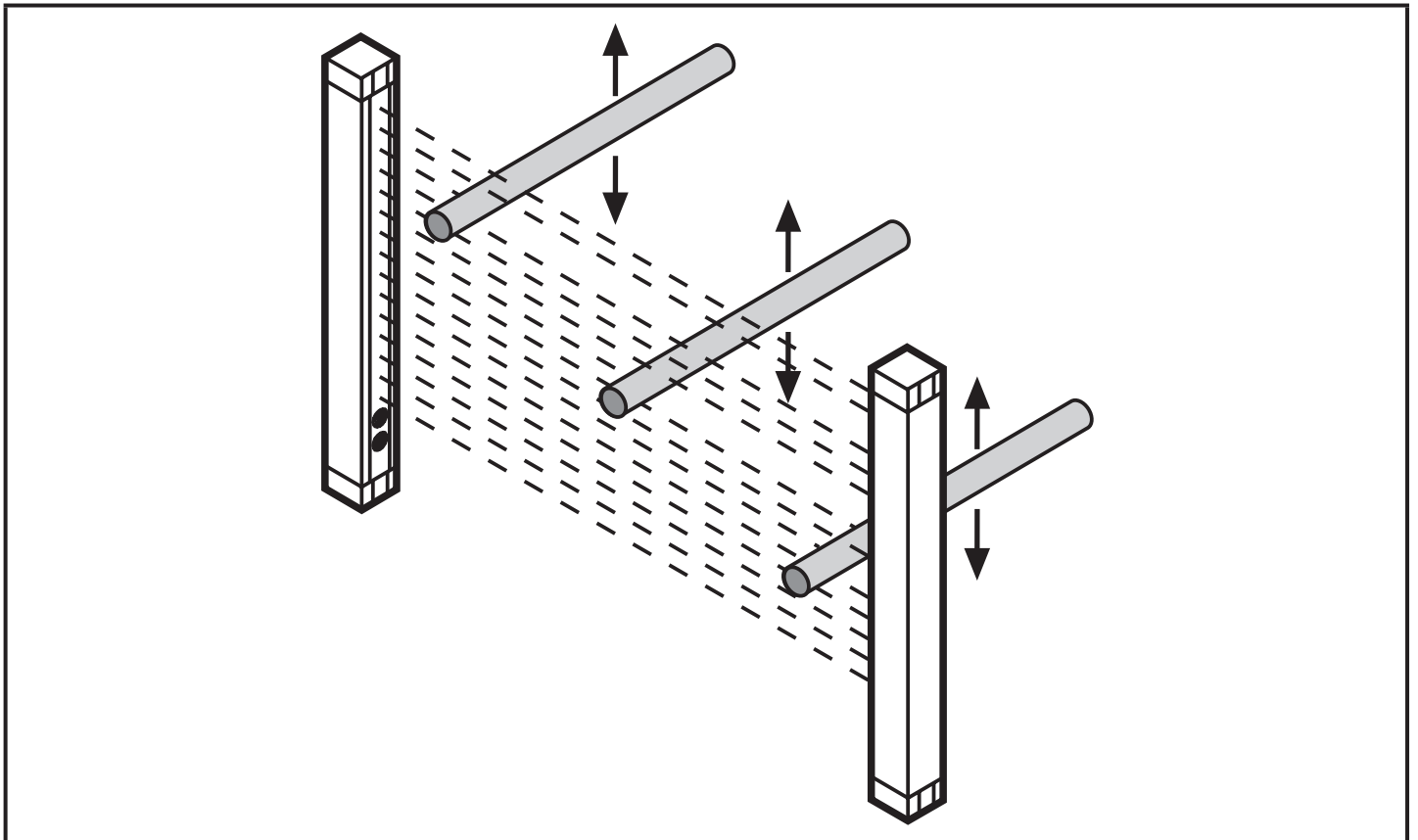

- ▶ Let the test object enter the protected area and move it slightly downwards. First of all in the centre and then close to the transmitter and the receiver.
- ▶ Make sure that the red LED on the receiver is continuously lit during the movement in the protected area.

 Observe the notes on installation of the safety light curtains / light grids
→ 14 Maintenance, repair and disposal.

 Notes on set-up → 16.1 Check list.

11 Scale drawing

11.1 safety light curtain

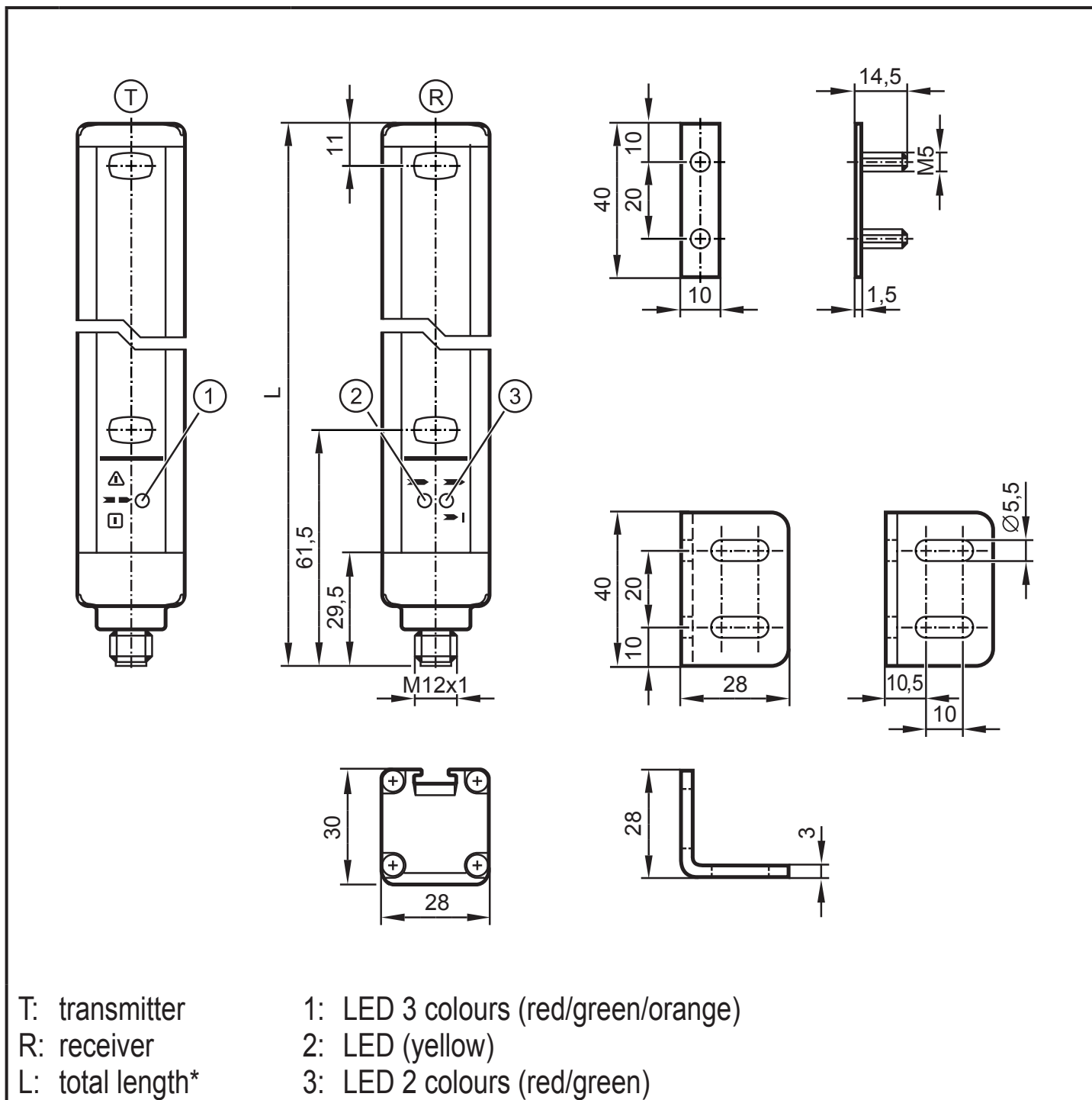

11.2 safety light grid

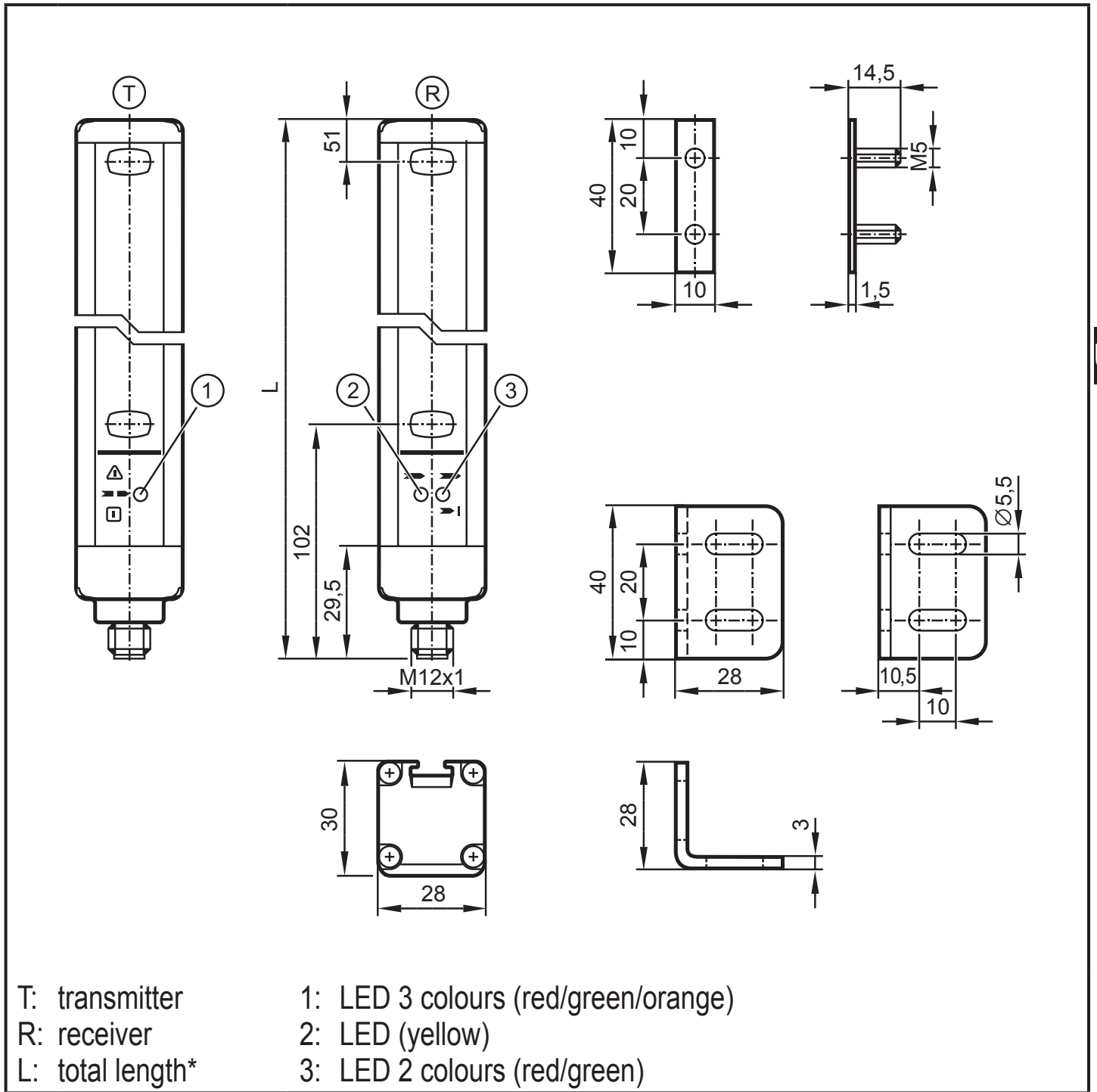

UK

* available lengths → 12 Technical data

12 Technical data

12.1 Safety light curtains / light grids type 2

Conforms to the requirements of: Type 2 IEC 61496-1, SILcl 1 IEC 62061, ISO 13849-1:2015 category 2 PL c	
Electrical design	DC / PNP
Operating voltage	24 DC (19.2...28.8)
Current consumption	
Transmitter [mA]	42
Receiver [mA]	83
Outputs (OSSDs)	2 x PNP
Max. current load per output [mA]	400 (24 V)
Max. capacitive load CL_max [μ F]	0.82
Power-on delay time [s]	< 2
Mission time T _M [h]	175200
EMC	IEC 61496-1
Vibration	IEC 61496-1
Shock	IEC 61496-1
Ambient temperature [°C]	-10...55
Max. perm relative air humidity [%]	95
Applications	Class C to EN 60654-1 weatherproof application
Protection	IP 65 / IP 67 / III
Housing material	aluminium, PC
Type of light	Infrared light 950 nm
Display	LED yellow, LED green, LED red
Connection	
Transmitter	M12
Receiver	M12
Max. cable length [m]	100 *)

*) for wire cross-section 0.34 mm²

12.1.1 Safety light curtains: 30 mm resolution



	OY031S	OY032S	OY033S	OY034S	OY035S	OY036S	OY037S	OY038S	OY039S	OY040S
Total length L [mm]	213	363	513	663	813	963	1113	1263	1413	1563
Protected area height [mm]	160	310	460	610	760	910	1060	1210	1360	1510
Response time [ms]	4,5	6	8	9,5	11	12,5	14,5	16	17,5	19,5
Safety-related reliability PFH _D [1/h]	2,0 ⁻⁰⁸	2,7 ⁻⁰⁸	3,3 ⁻⁰⁸	3,9 ⁻⁰⁸	4,5 ⁻⁰⁸	5,1 ⁻⁰⁸	5,8 ⁻⁰⁸	6,4 ⁻⁰⁸	7,0 ⁻⁰⁸	7,6 ⁻⁰⁸
Test pulse duration t _i [μs]	100	100	100	100	100	100	100	100	100	100
Test pulse interval T [ms]	60	60	60	60	60	60	60	60	60	60

UK

12.1.2 Safety light curtains: 40 mm resolution

	OY051S	OY052S	OY053S	OY054S	OY055S	OY056S	OY057S	OY058S	OY059S	OY060S
Total length L [mm]	213	363	513	663	813	963	1113	1263	1413	1563
Protected area height [mm]	160	310	460	610	760	910	1060	1210	1360	1510
Response time [ms]	4	5	6	7	8	9,5	10,5	11,5	12,5	13,5
Safety-related reliability PFH _D [1/h]	1,8 ⁻⁰⁸	2,3 ⁻⁰⁸	2,7 ⁻⁰⁸	3,2 ⁻⁰⁸	3,6 ⁻⁰⁸	4,1 ⁻⁰⁸	4,5 ⁻⁰⁸	5,0 ⁻⁰⁸	5,4 ⁻⁰⁸	5,9 ⁻⁰⁸
Test pulse duration t _i [μs]	100	100	100	100	100	100	100	100	100	100
Test pulse interval T [ms]	60	60	60	60	60	60	60	60	60	60

12.1.3 Safety light curtains: 50 mm resolution

 	OY072S	OY073S	OY074S	OY075S	OY076S	OY077S	OY078S	OY079S	OY080S
Total length L [mm]	363	513	663	813	963	1113	1263	1413	1563
Protected area height [mm]	310	460	610	760	910	1060	1210	1360	1510
Response time [ms]	4,5	5,5	6	7	8	9	10	10,5	11,5
Safety-related reliability PFH _D [1/h]	2,1 ⁻⁰⁸	2,5 ⁻⁰⁸	2,8 ⁻⁰⁸	3,2 ⁻⁰⁸	3,6 ⁻⁰⁸	3,9 ⁻⁰⁸	4,3 ⁻⁰⁸	4,6 ⁻⁰⁸	5,0 ⁻⁰⁸
Test pulse duration t _i [μs]	100	100	100	100	100	100	100	100	100
Test pulse interval T [ms]	60	60	60	60	60	60	60	60	60

12.1.4 Safety light curtains: 90 mm resolution

	OY094S	OY095S	OY096S	OY097S	OY098S	OY099S	OY100S
Total length L [mm]	663	813	963	1113	1263	1413	1563
Protected area height [mm]	610	760	910	1060	1210	1360	1510
Response time [ms]	4	4,5	5	5,5	6	6,5	7
Safety-related reliability PFH _D [1/h]	2,3 ⁻⁰⁸	2,5 ⁻⁰⁸	2,7 ⁻⁰⁸	3,0 ⁻⁰⁸	3,2 ⁻⁰⁸	3,4 ⁻⁰⁸	3,6 ⁻⁰⁸
Test pulse duration t _i [μs]	100	100	100	100	100	100	100
Test pulse interval T [ms]	60	60	60	60	60	60	60

12.1.5 Safety light grids 2, 3 and 4 beams

	OY111S	OY112S	OY113S
Number of beams	2	3	4
Total length L [mm]	653	953	1053
Protected area height [mm]	510	810	910
Response time [ms]	3	3,5	3,5
Safety-related reliability PFH _D [1/h]	1,7 ⁻⁰⁸	1,9 ⁻⁰⁸	2,0 ⁻⁰⁸
Test pulse duration t _i [μs]	100	100	100
Test pulse interval T [ms]	60	60	60

12.2 Safety light curtains / light grids type 4

Conforms to the requirements of: Type 4 IEC 61496-1, SILcl 3 IEC 62061, ISO 13849-1:2015 category 4 PL e	
Electrical design	DC / PNP
Operating voltage	24 DC (19.2...28.8)
Current consumption	
Transmitter [mA]	42
Receiver [mA]	83
Outputs (OSSDs)	2 x PNP
Max. current load per output [mA]	400 (24 V)
Max. capacitive load CL_max [μ F]	0.82
Power-on delay time [s]	< 2
Mission time T _M [h]	175200
EMC	IEC 61496-1
Vibration	IEC 61496-1
Shock	IEC 61496-1
Ambient temperature [°C]	-10...55
Max. perm relative air humidity [%]	95
Applications	Class C to EN 60654-1 weatherproof application
Protection	IP 65 / IP 67 / III
Housing material	aluminium, PC
Type of light	Infrared light 950 nm
Display	LED yellow, LED green, LED red
Connection	
Transmitter	M12
Receiver	M12
Max. cable length [m]	100 *)

*) for wire cross-section 0.34 mm²



12.2.1 Safety light curtains: 30 mm resolution

	OY041S	OY042S	OY043S	OY044S	OY045S	OY046S	OY047S	OY048S	OY049S	OY050S
Total length L [mm]	213	363	513	663	813	963	1113	1263	1413	1563
Protected area height [mm]	160	310	460	610	760	910	1060	1210	1360	1510
Response time [ms]	4	5,5	7,5	8,5	10,5	12	14	15,5	17	18,5
Safety-related reliability PFH _D [1/h]	7,1 ⁻⁰⁹	8,2 ⁻⁰⁹	9,5 ⁻⁰⁹	1,1 ⁻⁰⁸	1,2 ⁻⁰⁸	1,3 ⁻⁰⁸	1,4 ⁻⁰⁸	1,5 ⁻⁰⁸	1,7 ⁻⁰⁸	1,8 ⁻⁰⁸
Test pulse duration t _i [μs]	80	80	80	80	80	80	80	80	80	80
Test pulse interval T [ms]	4,0	5,7	7,3	9,0	10,6	12,3	13,9	15,6	17,2	18,9

12.2.2 Safety light curtains: 40 mm resolution

	OY061S	OY062S	OY063S	OY064S	OY065S	OY066S	OY067S	OY068S	OY069S	OY070S
Total length L [mm]	213	363	513	663	813	963	1113	1263	1413	1563
Protected area height [mm]	160	310	460	610	760	910	1060	1210	1360	1510
Response time [ms]	3,5	4	5,5	6,5	7,5	9	10	11	12	13
Safety-related reliability PFH _D [1/h]	6,8 ⁻⁰⁹	7,8 ⁻⁰⁹	8,6 ⁻⁰⁹	9,5 ⁻⁰⁹	1,0 ⁻⁰⁸	1,1 ⁻⁰⁸	1,2 ⁻⁰⁸	1,3 ⁻⁰⁸	1,4 ⁻⁰⁸	1,5 ⁻⁰⁸
Test pulse duration t _i [μs]	80	80	80	80	80	80	80	80	80	80
Test pulse interval T [ms]	3,5	4,6	5,7	6,8	7,9	9,0	10,1	11,2	12,3	13,4

12.2.3 Safety light curtains: 50 mm resolution

 	OY082S	OY083S	OY084S	OY085S	OY086S	OY087S	OY088S	OY089S	OY090S
Total length L [mm]	363	513	663	813	963	1113	1263	1413	1563
Protected area height [mm]	310	460	610	760	910	1060	1210	1360	1510
Response time [ms]	4	4,5	5,5	6,5	7,5	8,5	9	10	11
Safety-related reliability PFH _D [1/h]	7,2 ⁻⁰⁹	7,9 ⁻⁰⁹	8,5 ⁻⁰⁹	9,2 ⁻⁰⁹	9,8 ⁻⁰⁹	1,0 ⁻⁰⁸	1,1 ⁻⁰⁸	1,2 ⁻⁰⁸	1,2 ⁻⁰⁸
Test pulse duration t _i [μs]	80	80	80	80	80	80	80	80	80
Test pulse interval T [ms]	4,0	4,8	5,7	6,6	7,5	8,4	9,2	10,1	11,0

12.2.4 Safety light curtains: 90 mm resolution

	OY104S	OY105S	OY106S	OY107S	OY108S	OY109S	OY110S
Total length L [mm]	663	813	963	1113	1263	1413	1563
Protected area height [mm]	610	760	910	1060	1210	1360	1510
Response time [ms]	4	4,5	5	5,5	5,5	6	6,5
Safety-related reliability PFH _D [1/h]	7,8 ⁻⁰⁹	8,3 ⁻⁰⁹	8,8 ⁻⁰⁹	9,3 ⁻⁰⁹	9,8 ⁻⁰⁹	1,0 ⁻⁰⁸	1,1 ⁻⁰⁸
Test pulse duration t _i [μs]	80	80	80	80	80	80	80
Test pulse interval T [ms]	4,0	4,4	4,8	5,3	5,7	6,2	6,6

UK

12.2.5 Safety light grids 2, 3 and 4 beams

	OY114S	OY115S	OY116S
Number of beams	2	3	4
Total length L [mm]	653	953	1053
Protected area height [mm]	510	810	910
Response time [ms]	2,5	3	3
Safety-related reliability PFH _D [1/h]	6,9 ⁻⁰⁹	7,6 ⁻⁰⁹	8,2 ⁻⁰⁹
Test pulse duration t _i [μs]	80	80	80
Test pulse interval T [ms]	2,6	2,9	3,1

13 Troubleshooting

The LEDs of the transmitter and the receiver indicate faulty operating states (→ 9 Operating and display elements). For a detailed fault description see the following tables.

13.1 Fault diagnosis transmitter

LED		Possible cause	Troubleshooting
red	2 consecutive pulses	Faulty connection pin 2/4	Check connections pins 2 and 4
red	3/4 consecutive pulses	Internal fault	Send device to ifm branch office for repair.

13.2 Fault diagnosis receiver

LED		Possible cause	Troubleshooting
red	2 consecutive pulses	Wrong configuration	Check connections.
red	3 consecutive pulses	Feedback external contactor missing	Check connection pin 4.
red	4 consecutive pulses	Interfering transmitter detected	Find interfering transmitter and take one of the following measures: <ul style="list-style-type: none"> - Reduce the range of the interfering transmitter from high to low. - Exchange position of transmitter and receiver. - Change location of the interfering transmitter so that the receiver is not influenced. - Screen the beams coming from the interfering transmitter using a mat protective device.
red	5 consecutive pulses	Fault OSSD outputs	Check connections. If the defect remains, send device to ifm branch for repair.
red	6/7/8 consecutive pulses	Internal fault	Send device to ifm branch office for repair.
yellow		Weak signal	<ul style="list-style-type: none"> - Check alignment of transmitter and receiver. - Clean front pane, check range. - Waiting for restart pulse.

14 Maintenance, repair and disposal

- Maintain the optoelectronic protective equipment in accordance with the applicable national regulations in effect within the requested intervals. The tests must be performed by qualified persons.
- It is recommended to regularly clean the front panes of the transmitter and the receiver.
- Clean the unit with a clean, damp cloth. In particularly dusty environments we recommend to spray the cleaned front pane with an antistatic product.
- Do not use any aggressive or abrasion-developing cleaning agents since they could attack the surfaces. To avoid electrostatic charging on the front do not use any woollen cloths.



Scratches on the front panes of the photoelectric safety sensors can deviate the light beams and impair the protective function.

- Only the manufacturer is allowed to repair the unit.
- After use dispose of the unit in an environmentally friendly way in accordance with the applicable national regulations.

15 Terms and abbreviations

Blanking		Optional function ensuring that objects are in the protected area which are larger than the detection capacity without the OSSDs switching off.
ESPE		Electro-Sensitive Protective Equipment
CCF	Common Cause Failure	
DC_{avg}	Average Diagnostic Coverage	
Muting		Temporary bridging of a safety function by safety-related parts of the control system.
$MTTF_d$	Mean Time To Dangerous Failure	
OSSD	Output Signal Switch Device	Output signal switch element, static safety-related output.
PFH (PFH_D)	Probability of (dangerous) Failure per Hour	
PL	Performance Level	Capability of safety-related parts to perform a safety function at predictable conditions to fulfil the expected risk reduction.
SIL	Safety integrity level	SIL 1-4 to IEC 61508. The higher the SIL the lower the probability that a safety function will fail.
SIL_{cl}	Safety integrity level _{claim limit}	(to IEC 62061)
T_M	Mission Time	

UK

Technical data and further information at www.ifm.com

16 Annex

16.1 Check list

This check list serves as help for setting up the safety light curtains / light grids. The requirements in this check list should to be met, however depending on the application and the directives / standards referred to.

1. Were the directives / standards valid for safety of machinery complied with?
2. Is access prevention / primary guarding of the point of danger only possible through the protected area of the safety light curtains / light grids?
3. Have steps been taken to prevent reaching under, over or around the light guards to prevent attempts to defeat them?
4. Has the stop or shutdown delay of the machine been measured and adapted according to the installation of the safety light curtains / light grids?
5. Have the safety light curtains / light grids been duly fixed and secured against loosening or movement?
6. Have the safety light curtains / light grids been checked according to the function and maintenance descriptions in these operating instructions?
7. Has external monitoring (EDM) of the control unit (e.g. contactor, valve etc.) been used?
8. Is the state defined as safe for switching on / off of the safety light curtains / light grids initiated?
9. Is /are there any soiling or scratches on the light-emitting surface?
10. Are the installation instructions of these operating instructions adhered to?



This check list does not replace checking or set-up by a person trained in safety matters.

