

ifm electronic

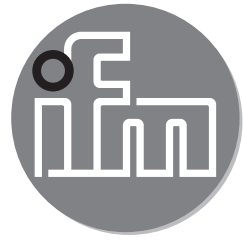

Operating instructions
optical fork sensor

efector200[®]

OPU2xx

UK

OPU201 / 00 02 / 2009

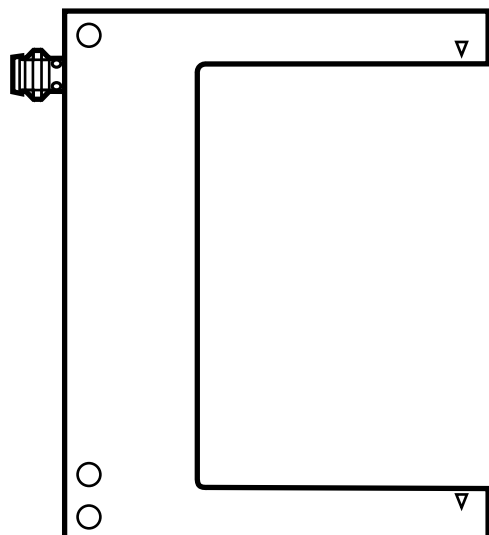

Contents

1 Preliminary note.....	3
1.1 Symbols used.....	3
2 Functions and features.....	3
3 Installation.....	3
4 Operating and display elements.....	3
5 Electrical connection.....	4
6 Setting.....	5
6.1 Setting of the output function.....	5
6.2 Sensitivity setting.....	5
7 Operation.....	6
8 Maintenance, repair and disposal.....	7

1 Preliminary note

1.1 Symbols used

► Instruction

> Reaction, result

→ Cross-reference



Important note

Non-compliance can result in malfunctions or interference.

2 Functions and features

UK

The optical fork sensor detects objects and materials without contact and indicates their presence by a switching signal.

3 Installation

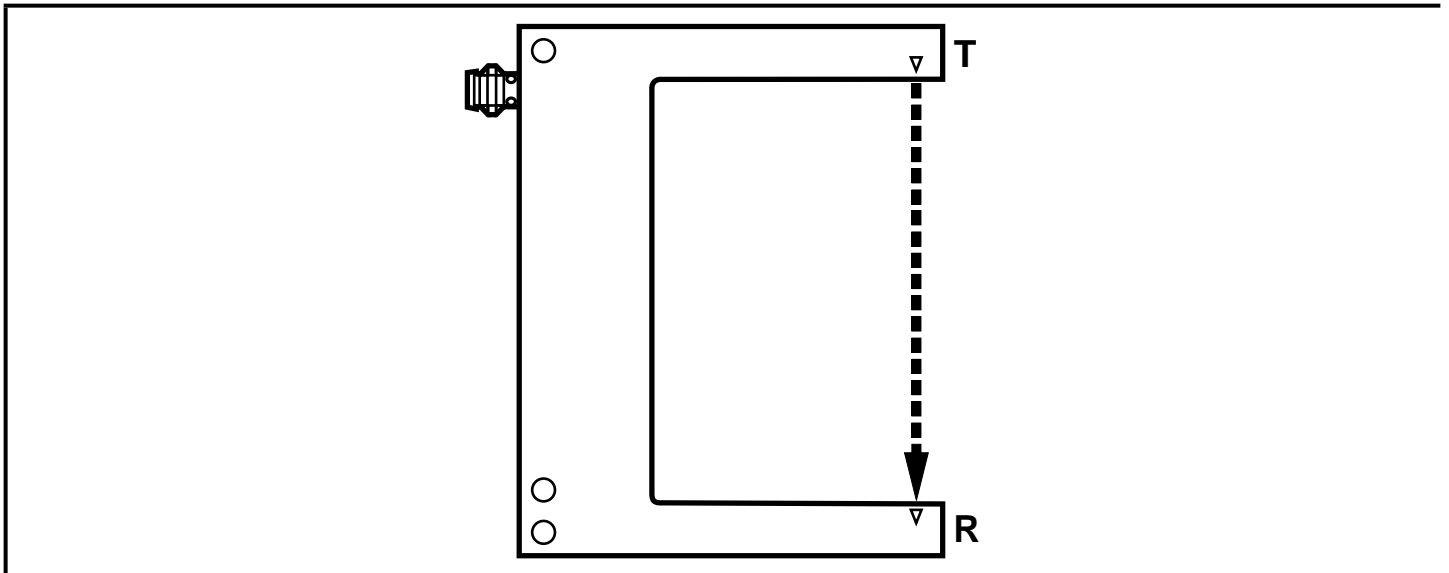

T: transmitter; R: receiver

► Secure the optical fork sensor (OPU...) to a bracket.

4 Operating and display elements

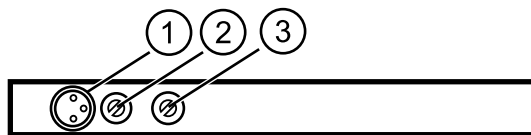

1: LED yellow

2: output function switch



3: sensitivity potentiometer



5 Electrical connection



The unit must be connected by a qualified electrician.

- ▶ The national and international regulations for the installation of electrical equipment must be adhered to.
- ▶ Ensure voltage supply to EN 50178, SELV, PELV.

The following indications apply if there is a UL listing mark on the product:

- ▶ For use in NFPA 79 applications only. Adapters providing field wiring means are available from the manufacturer. Refer to manufacturers information.
- ▶ The device shall be supplied from an isolating transformer having a secondary Listed fuse rated
 - a) max 5 amps for voltages 0...20 Vrms (0...28.3 Vp) or
 - b) 100/Vp for voltages of 20...30 Vrms (28.3...42.4 Vp).

- ▶ Disconnect power.
- ▶ Connect the unit as follows:

DC PNP

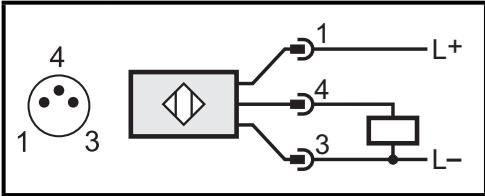

pin 1 = L+
pin 3 = L-
pin 4 = load

DC NPN

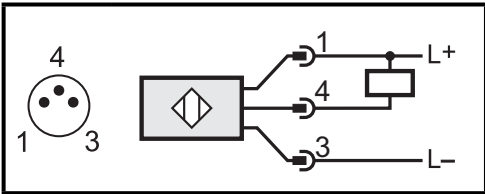

pin 1 = L+
pin 3 = L-
pin 4 = load

6 Setting

6.1 Setting of the output function

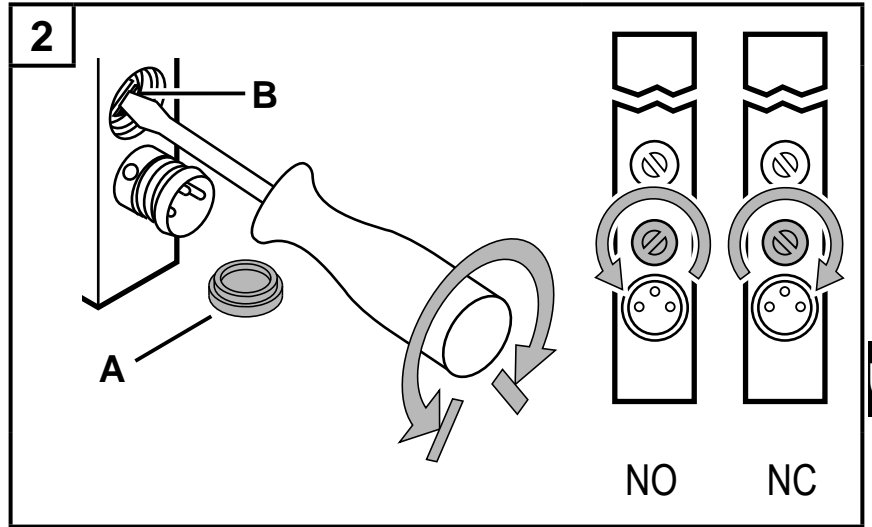
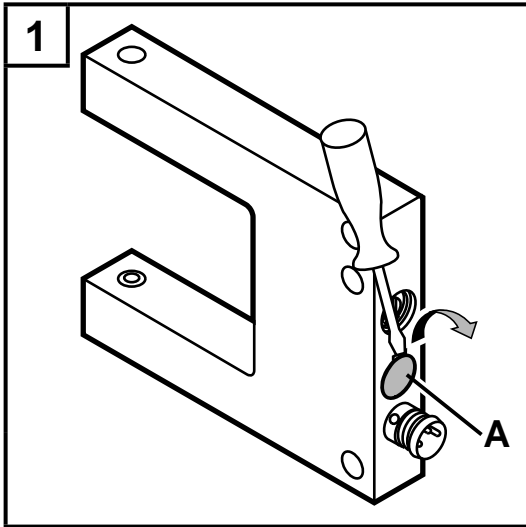

A: cover; B: output function switch

1. Remove the cover (A).
2. Set the output function (NO/NC) via the switch (B) using a screwdriver.
3. Refit the cover (A).

6.2 Sensitivity setting

The sensor is to switch when the object is detected

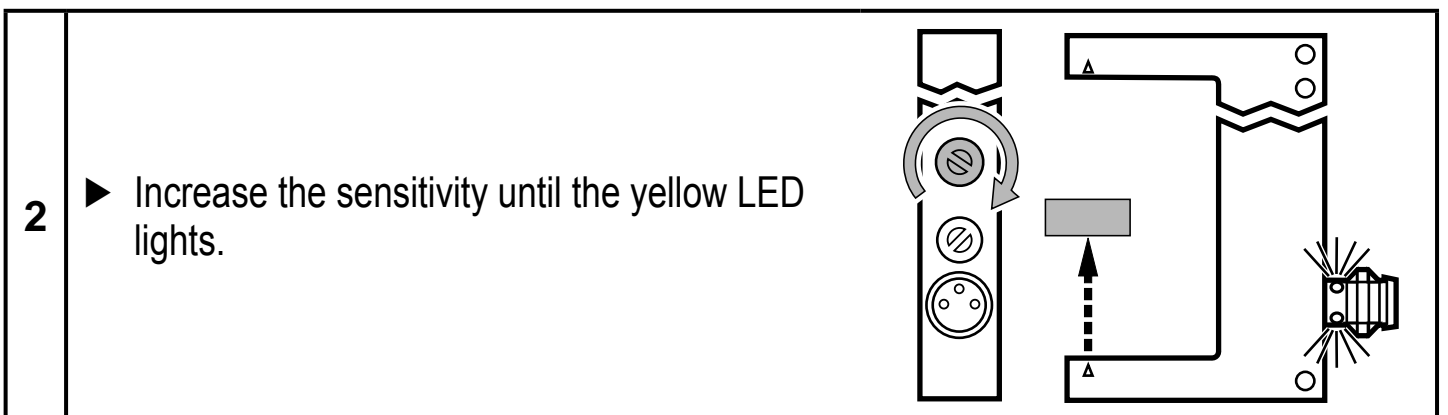
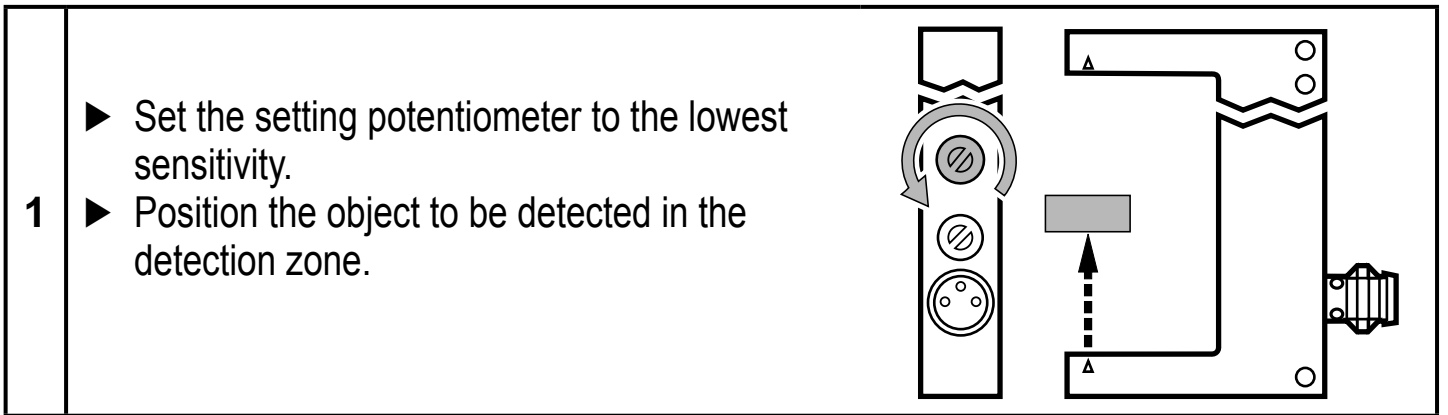

UK

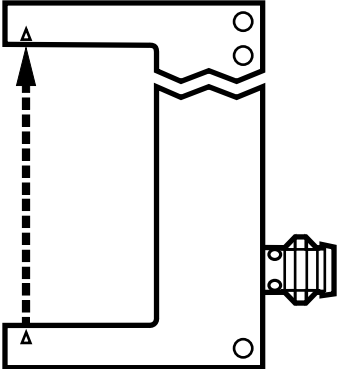
<p>3</p> <ul style="list-style-type: none"> ▶ Remove the object from the detection zone. > The yellow LED goes out. The setting operation is completed. 	
---	--

The sensor is not to switch when the object is detected

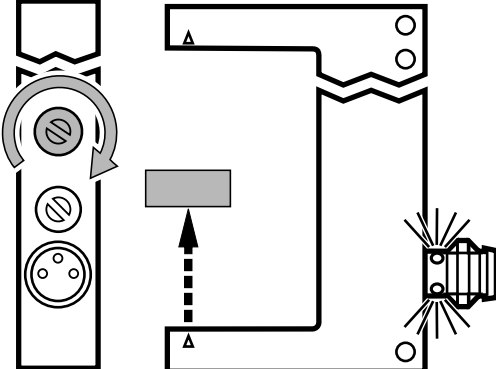
<p>1</p> <ul style="list-style-type: none"> ▶ Set the setting potentiometer to the highest sensitivity. The yellow LED is lit. ▶ Position the object to be detected in the detection zone. 	
---	--

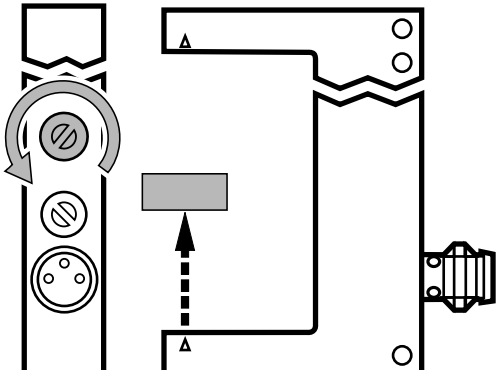
<p>2</p> <ul style="list-style-type: none"> ▶ Reduce the sensitivity until the yellow LED goes out. 	
---	--

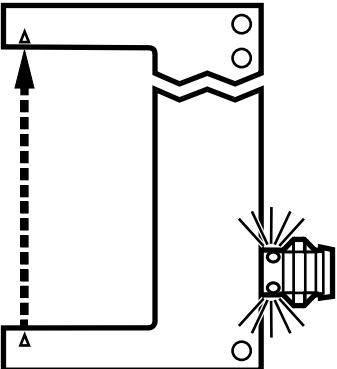
<p>3</p> <ul style="list-style-type: none"> ▶ Remove the object from the detection zone. > The yellow LED is lit again. The setting operation is completed. 	
---	---

7 Operation

- ▶ Check whether the unit operates correctly.
- > The yellow LED is lit when the output is switched.

8 Maintenance, repair, disposal

- ▶ Keep the lens of the sensor free from soiling.
- ▶ For cleaning do not use any solvents or cleaning agents which could damage the lens.
- ▶ After use dispose of the unit in an environmentally friendly way in accordance with the applicable national regulations.

Faulty sensors must only be repaired by the manufacturer.

Technical data and further information at
www.ifm.com → Select your country → Data sheet direct:

UK