

ifm electronic



Operating instructions
Retro-reflective sensor

efector200[®]

OJ51xx laser

UK

704808 / 00 05 / 2010

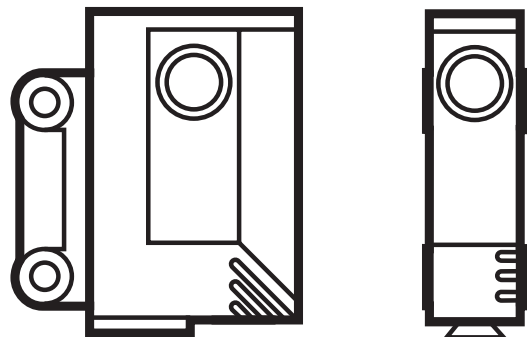

Contents

1 Preliminary note.....	3
1.1 Symbols used.....	3
2 Safety instructions	3
3 Functions and features	4
4 Installation	4
5 Electrical connection.....	5
6 Setup	5
7 Settings.....	6
7.1 Setting of the sensitivity with stationary objects*	6
7.2 Setting of the sensitivity with moving objects*	7
7.3 Setting of the maximum sensitivity*	8
7.4 Electronic lock	8
7.5 Programming the output function*	8
8 Operation.....	9
9 Maintenance, repair and disposal.....	9

1 Preliminary note

1.1 Symbols used

▶ Instruction

> Reaction, result

→ Cross-reference



Important note

Non-compliance can result in malfunctions or interference.



Information

Supplementary note.

UK

2 Safety instructions

According to the cULus approval

Caution - Use of controls or adjustments or procedures other than those specified herein may result in hazardous radiation exposure.



Visible laser light; CLASS 1 LASER PRODUCT.

IEC 60825-1 : 2007

Complies with 21 CFR 1040.10 except for deviations pursuant to Laser Notice No. 50, dated June 2007.

Position of the product label

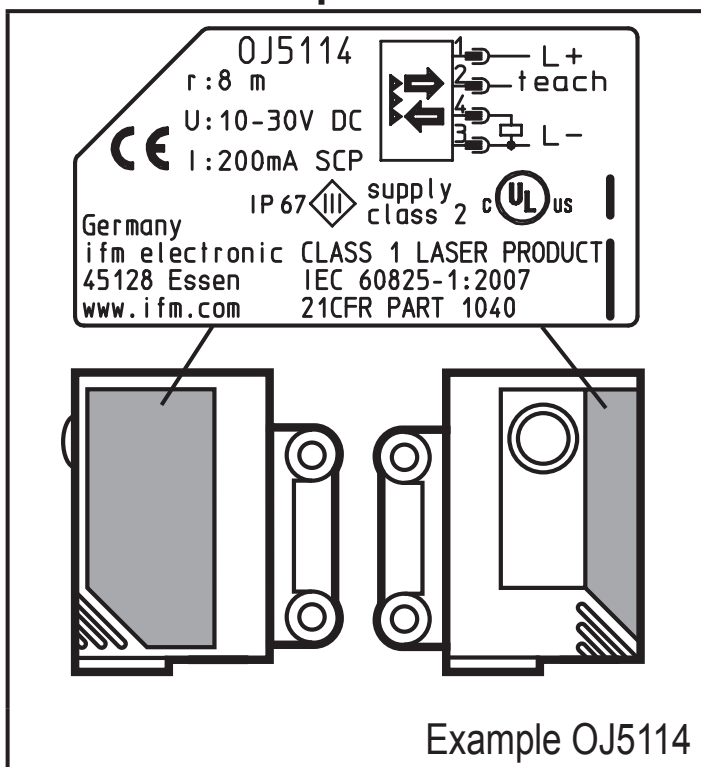

Additional label

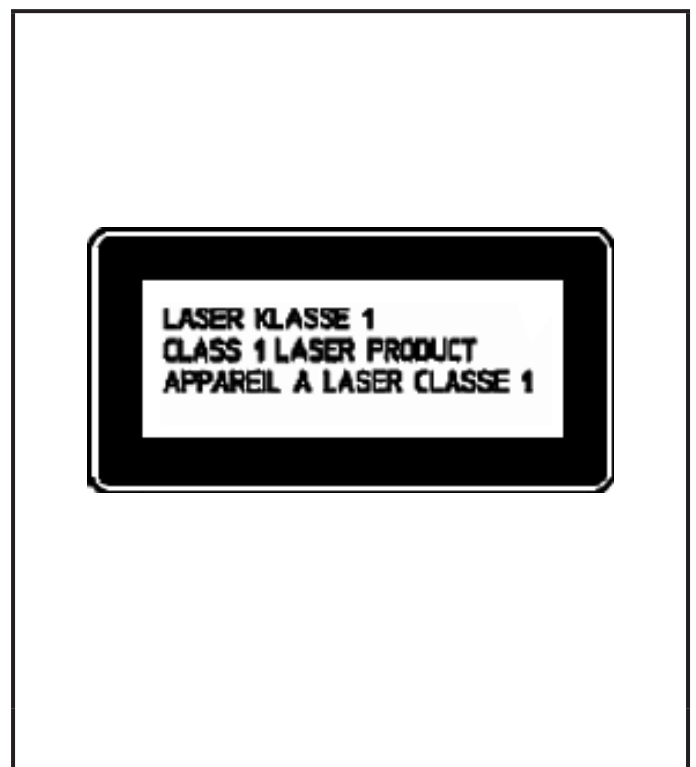

3 Functions and features

In conjunction with a prismatic reflector or reflective tape the retro-reflective sensor detects objects and materials without contact and indicates their presence by a switching signal.

Range: see type label (value referred to prismatic reflector 50 mm x 50 mm).

The highly focussed units detect very small objects. Therefore a suitable prismatic reflector (e.g. E20722) has to be used.

4 Installation

Side lens*

Front lens*

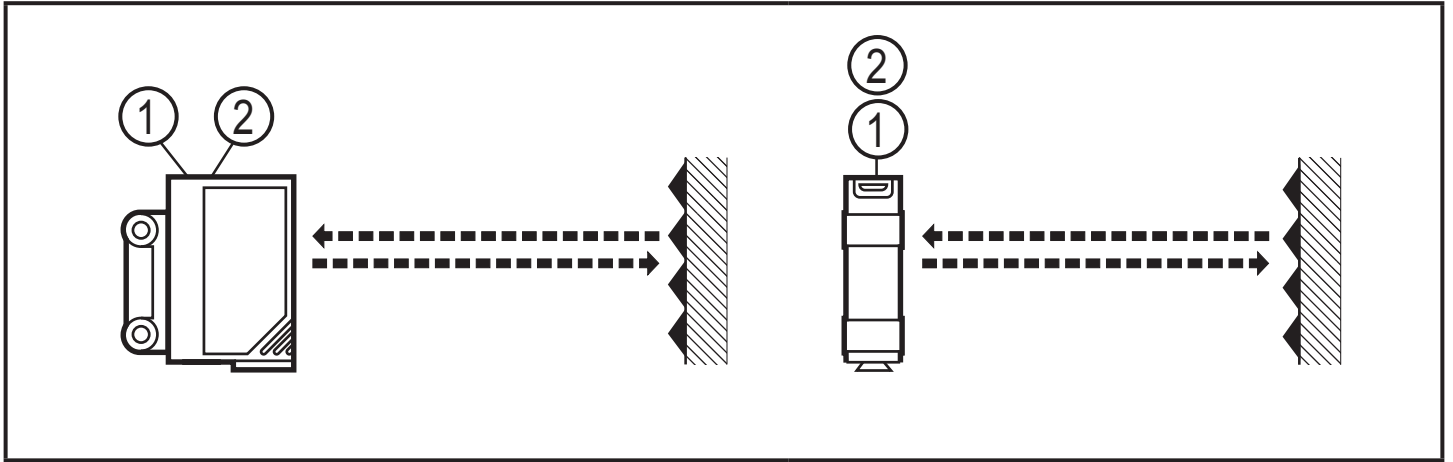

- 1: LED
- 2: pushbutton

* In the following sections installation and setup are described using the example of the type with front lens. The functions of the units with side lens are identical.

- ▶ Fix the prismatic reflector or the reflective tape.
- ▶ Align the retro-reflective sensor to it and secure it to a bracket; the light spot must hit the prismatic reflector.

Maximum range is only possible with precise alignment.



- ▶ Mount the unit so that the mounting position cannot change (avoid high vibrations!).

Laser units with a very small light spot diameter are highly focussed; the slightest change in the mounting position will result in misalignment.

The optical position of the laser beam may deviate slightly from the mechanical axis. Therefore we recommend using the fine adjustment units E21225 (front lens) or E21226 (side lens) when mounting the laser units.

5 Electrical connection



The unit must be connected by a qualified electrician.

- ▶ The national and international regulations for the installation of electrical equipment must be adhered to.
 - ▶ Voltage supply according to EN 50178.
- ▶ Disconnect power.
- ▶ Connect the unit as follows:

UK

DC PNP

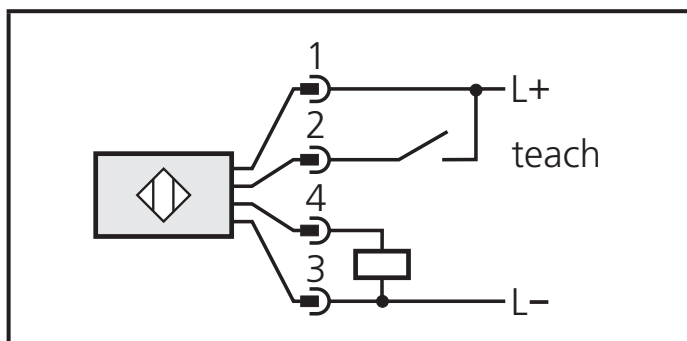

Programming of the output function by pushbutton or programming wire (→ 7.5 Programming the output function).

6 Setup

The retro-reflective sensor is supplied ready to operate (plug & play) set at the max. sensing range. This is sufficient if the retro-reflective sensor can operate with maximum excess gain. The following setting procedures should only be necessary in less straight-forward applications, for example if partly transparent objects must be detected.

7 Settings

7.1 Setting of the sensitivity with stationary objects*

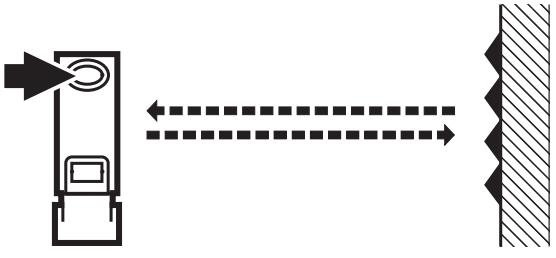
1	<p>▶ Go into the programming mode of the unit.</p> <p>▶ Press for about 2 s until the red LED flashes.</p>	
	<p>> The red LED goes out; the yellow and green LEDs flash alternately.</p> <p>> The unit is in the programming mode.</p>	

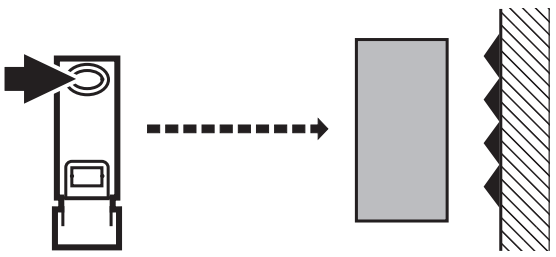
2	<p>Set the sensitivity with object.</p> <p>▶ Press once.</p>	
	<p>> The yellow and green LEDs go out for approx. 1 s, then flash again alternately.</p>	

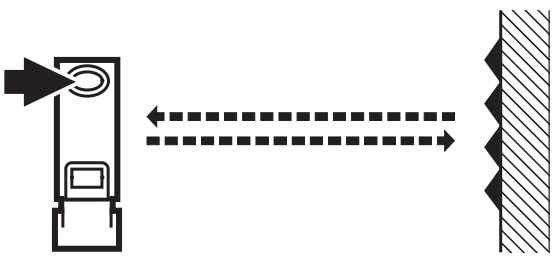
3	<p>Set the sensitivity without object.</p> <p>▶ Press once.</p>	
	<p>> The yellow and green LEDs go out for approx. 1 s., after approx. 3 s the green LED is on.</p> <p>> The unit is in the operating mode.</p>	

Setting steps 2 and 3 can also be carried out in reverse order.

* The sensitivity can also be set in exactly the same way using the programming wire (pin 2 / WH). To activate the functions the programming wire is connected to L+ (pin 1 / BN) for PNP units or to L- (pin 3 / BU) for NPN units for the appropriate time. Feedback: If setting was not successful via the programming wire, the output will switch for 2 s. The unit then passes into the operating mode with the sensitivity being unchanged.



If the setting of the sensitivity is not possible (e.g. object signal and background signal are about the same), the red LED flashes after step 3 for approx. 2 s. The unit then passes into the operating mode with the sensitivity being unchanged.

If the setting button is not activated for 15 minutes during the programming process, the unit passes automatically into the operating mode with the sensitivity being unchanged.

7.2 Setting of the sensitivity with moving objects*

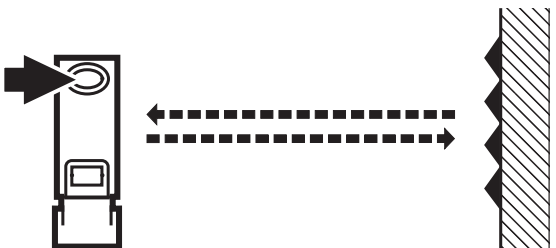
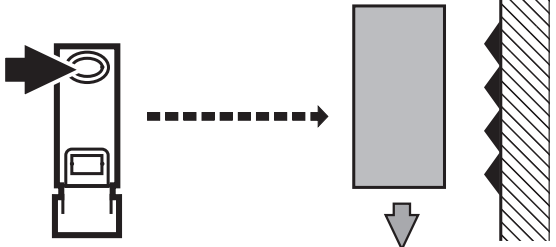
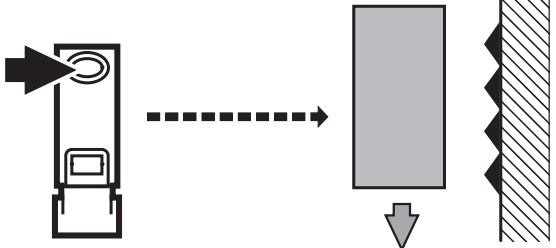
1	<p>Go into the programming mode of the unit.</p> <p>▶ Press for about 2 s until the red LED flashes.</p> 	UK
<p>> The red LED goes out; the yellow and green LEDs flash alternately.</p> <p>> The unit is in the programming mode.</p>		
2	<p>▶ Allow objects to pass through the detection area during the measurement (about 1 s) (number of the objects between min. 8 Hz and max. switching frequency).</p> <p>▶ Press once.</p> 	
<p>> The yellow and green LEDs go out for approx. 1 s, then flash again alternately.</p>		
3	<p>▶ Allow objects to pass through the detection area during the measurement (about 1 s) (number of the objects between min. 8 Hz and max. switching frequency).</p> <p>▶ Press once.</p> 	
<p>> The yellow and green LEDs go out for approx. 1 s., after approx. 3 s the green LED is on.</p> <p>> The unit is in the operating mode.</p>		

* The sensitivity can also be set in exactly the same way using the programming wire (pin 2 / WH). To activate the functions the programming wire is connected to L+ (pin 1 / BN)

for PNP units or to L- (pin 3 / BU) for NPN units for the appropriate time. Feedback: If setting was not successful via the programming wire, the output will switch for 2 s. The unit then passes into the operating mode with the sensitivity being unchanged.



If the setting of the sensitivity is not possible (e.g. object signal and background signal are about the same), the red LED flashes after step 3 for approx. 2 s. The unit then passes into the operating mode with the sensitivity being unchanged.

If the setting button is not activated for 15 minutes during the programming process, the unit passes automatically into the operating mode with the sensitivity being unchanged.

7.3 Setting of the maximum sensitivity*

- ▶ Go into the programming mode of the unit. (→ step 1).
- ▶ Align the sensor so that no light is reflected.
- ▶ Press the setting button twice (→ steps 2 and 3).

* The maximum sensitivity can also be set in exactly the same way using the programming wire (pin 2 / WH). To activate the functions the programming wire is connected to L+ (pin 1 / BN) for PNP units or to L- (pin 3 / BU) for NPN units for the appropriate time.

7.4 Electronic lock

Activate the lock by connecting the programming wire for about 15 s -20 s*.

De-activate the lock by connecting the programming wire again for 15 s - 20 s*.

* To activate the functions the programming wire (pin 2 / WH) is connected to L+ (pin 1 / BN) for PNP units or to L- (pin 3 / BU) for NPN units for the appropriate time.

7.5 Programming the output function*

<p>▶ Press for 10 s.</p> 	<ul style="list-style-type: none">> The red LED starts to flash fast after 2 s.> Then the yellow and green LEDs flash alternately.> After 10 s all LEDs go off, the output function has changed from light-on mode to dark-on mode (or vice versa).
--	--

* The output function can be programmed in exactly the same way using the programming wire (pin 2 / WH). To activate the functions the programming wire is connected to L+ (pin 1 / BN) for PNP units or to L- (pin 3 / BU) for NPN units for the appropriate time.

8 Operation

- ▶ Check whether the unit operates correctly.
- > Display by LEDs.

Green LED on	Unit is ready for operation.
Yellow LED on	Output is switched.
Red LED on	Error in object detection, e.g. maladjustment, soiling of the lenses
LEDs yellow + red	Flash alternately, 2 Hz: output short-circuited. Flash alternately, 1 Hz: internal fault. (output is not switched).

UK

9 Maintenance, repair and disposal

- ▶ Keep the lenses of the sensor free from soiling.
- ▶ For cleaning do not use any solvents or cleaning agents which could damage the plastic lenses.
- ▶ Do not try to open the module enclosure. There are no user - serviceable components inside.

Technical data and further information at
www.ifm.com → Select your country → Data sheet direct: