

ifm electronic



Operating instructions
Optical distance sensor

efector200[®]

OID25x

UK

80228366 / 00 03 / 2015

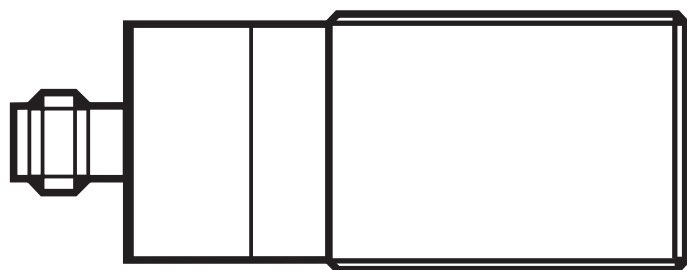

Contents

1 Preliminary note.....	3
1.1 Symbols used	3
2 Safety instructions	3
3 Functions and features	4
3.1 Applications	4
4 Installation.....	5
4.1 Installation conditions	5
5 Electrical connection.....	5
6 Operating and display elements	6
7 Settings / operation.....	6
7.1 Switch off the laser	6
8 IO-Link	7
8.1 General information	7
8.2 Device-specific information.....	7
8.3 Parameter setting tools.....	7
9 Maintenance, repair, disposal.....	7

1 Preliminary note

1.1 Symbols used

► Instructions

> Reaction, result

[...] Designation of keys, buttons or indications

→ Cross-reference



Important note

Non-compliance may result in malfunction or interference.



Information

Supplementary note

UK

2 Safety instructions

- Read this document prior to set-up of the unit. Ensure that the product is suitable for your application without any restrictions.
- Improper or non-intended use may lead to malfunctions of the unit or to unwanted effects in your application. That is why installation, electrical connection, set-up, operation and maintenance of the unit must be carried out by qualified personnel authorised by the machine operator.
- In case of malfunction of the unit please contact the manufacturer. If the unit is tampered with and/or modified, any liability and warranty is excluded.
- The unit complies with the standard EN 61000-6-4. The unit may cause radio interference in domestic areas. If interference occurs, the user must take appropriate remedial actions.

According to cULus

Caution - Use of controls or adjustments or procedures other than those specified herein may result in hazardous radiation exposure.



Visible laser light; CLASS 1 LASER PRODUCT.

IEC 60825-1:2007

Complies with 21 CFR 1040.10 except for deviations according to Laser Notice No. 50, dated June 2007

Position of the product label

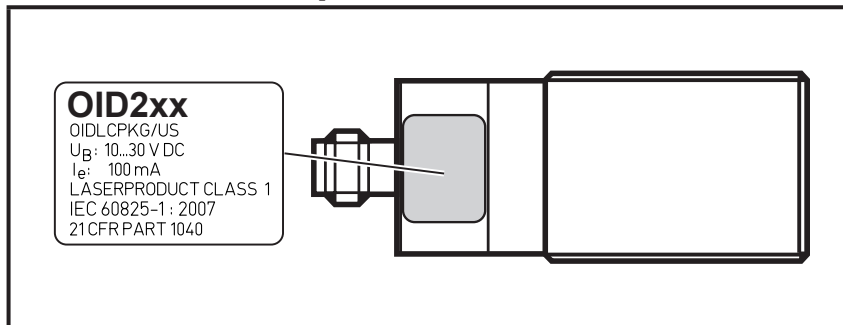

Warning sign

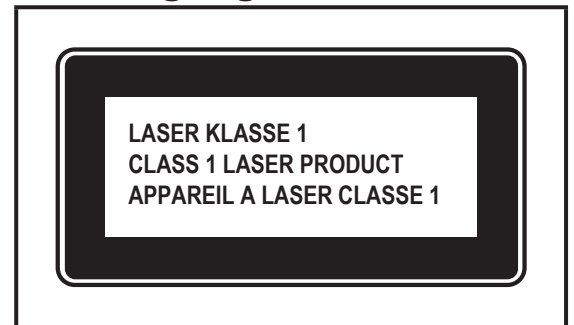

3 Functions and features

The unit is used as an optical distance sensor.

3.1 Applications

- The optical distance sensor measures distances between 0.03 and 2 m.
- It has a background suppression of up to 20 m.
- The switching outputs are complementary.



The distance between the sensor and the background must be limited to max. 20 m by the customer. Otherwise measured values can be ambiguous → 4.1 Installation conditions.

4 Installation

4.1 Installation conditions

- ▶ Install the unit so that the object to be detected is within a measuring range of 0.03...2 m.

Any object between the set switch point and a distance of 20 m from the sensor is suppressed.

-  Reflecting surfaces in the direct beam path of the sensor – also in the range > 20 m – are to be avoided by the customer. Otherwise the measured values can be ambiguous.

UK

5 Electrical connection

-  The unit must be connected by a qualified electrician.
- ▶ The national and international regulations for the installation of electrical equipment must be adhered to.
- ▶ Ensure voltage supply to EN 50178, SELV, PELV.
- ▶ Disconnect power.
- ▶ Connect the unit as follows:

DC PNP

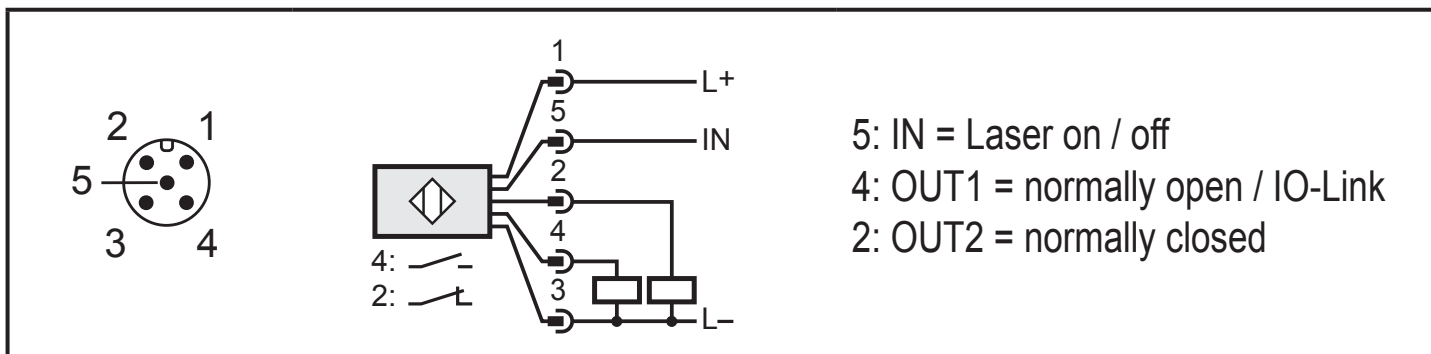

Core colours of ifm sockets:

1 = BN (brown), 2 = WH (white), 3 = BU (blue), 4 = BK (black), 5 = GR (grey)

6 Operating and display elements

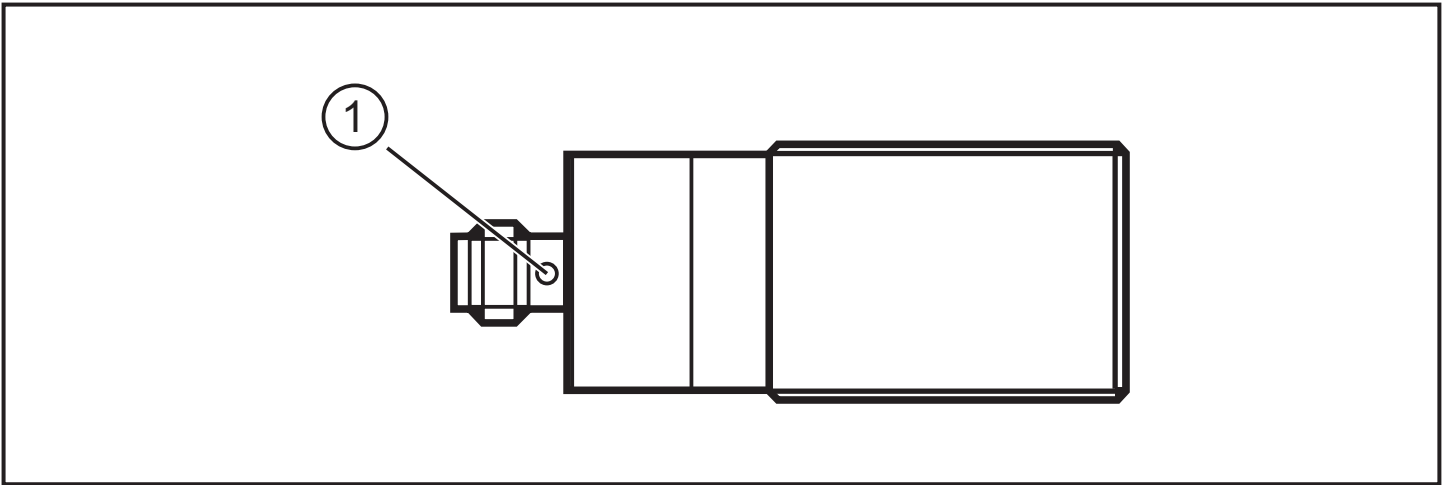

1: LED yellow: Set value reached, output OUT1 = High (if OUT1 is configured as NO)

7 Settings / operation

The unit is set via the IO-Link interface. (→ 8 IO-Link)

On delivery the unit can also be used without IO-Link. Preset switch point: 2 m

- After installation, electrical connection and programming, check whether the unit operates correctly.



Lifetime of a laser diode: 50,000 hours

7.1 Switch off the laser

For safety and maintenance purposes the laser of the unit can be temporarily switched off via the input on pin 5.

Input signal at pin 5	Laser
Low / not connected	On
High	Off

8 IO-Link

8.1 General information

This unit has an IO-Link communication interface which requires an IO-Link-capable module (IO-Link master) for operation.

The IO-Link interface enables direct access to the sensor values and parameters and provides the possibility to set the parameters of the unit during operation.

In addition communication is possible via a point-to-point connection with a USB adapter cable.

You will find more detailed information about IO-Link at www.ifm.com/uk/io-link.

UK

8.2 Device-specific information

You will find the IODDs necessary for the configuration of the IO-Link device and detailed information about sensor values, diagnostic information and parameters in the overview table at www.ifm.com/uk/io-link.

8.3 Parameter setting tools

You will find all necessary information about the required IO-Link hardware and software (e.g. ifm LINERECORDER SENSOR ZGS210) at www.ifm.com/uk/io-link.

9 Maintenance, repair, disposal

Faulty sensors must only be repaired by the manufacturer.

- ▶ Keep the front lens of the sensor clean.
- ▶ After use dispose of the unit in an environmentally friendly way in accordance with the applicable national regulations.
- ▶ Do not open the module housing. There are no user-serviceable components inside.

Technical data and further information at www.ifm.com