

ifm electronic



Operating instructions
Diffuse reflection sensor with
background suppression

efector200[®]

OGH7xx

UK

704076 / 03 06 / 2011



1 Preliminary note

1.1 Symbols used

- ▶ Instruction
- > Reaction, result
- [...] Designation of pushbuttons, buttons or indications
- Cross-reference



Important note

Non-compliance can result in malfunctions or interference.

2 Safety instructions

According to the cULus approval

Caution - Use of controls or adjustments or procedures other than those specified herein may result in hazardous radiation exposure.



Visible laser light; CLASS 1 LASER PRODUCT.

IEC 60825-1 : 2007

Complies with 21 CFR 1040.10 except for deviations pursuant to Laser Notice No. 50, dated June 2007.

Position of the product label

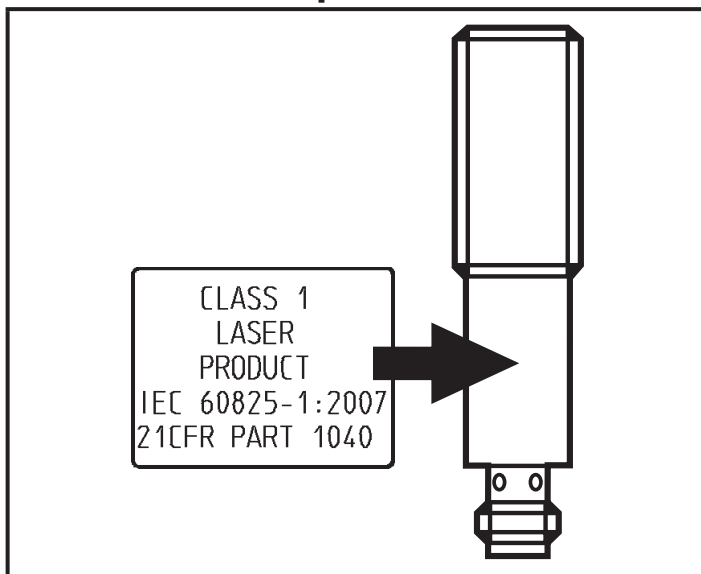

Additional label

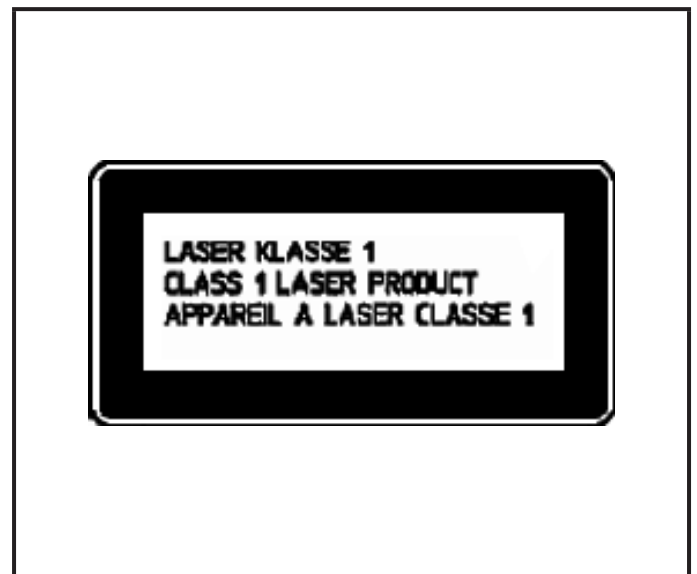

3 Functions and features

The diffuse reflection sensor detects objects and materials without contact and indicates their presence by a switching signal.

Range 20 ... 200 mm (on white paper 200 x 200 mm, 90 % remission)

4 Installation

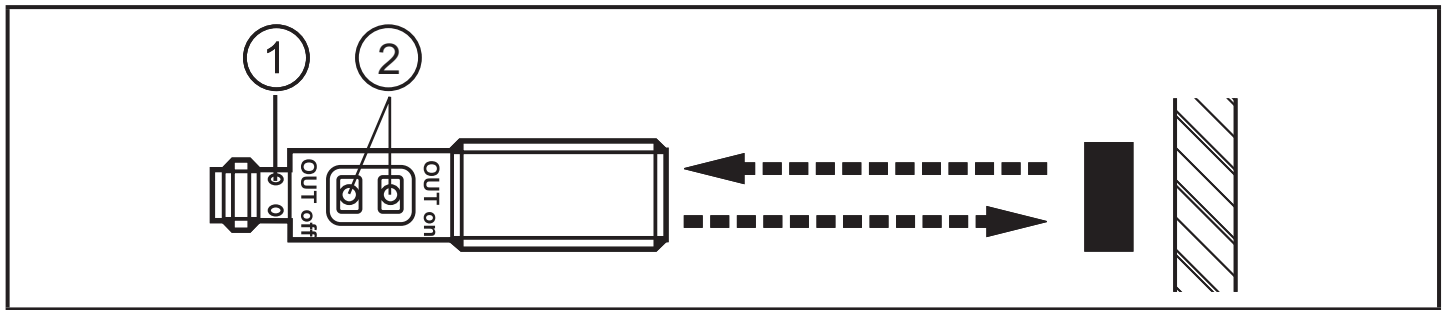

- 1: LED
- 2: programming buttons

- ▶ Align the diffuse reflection sensor to the object to be detected.
- ▶ Secure it to a bracket.

UK

Note:

The objects to be detected are to move transversally to the lens of the sensor.

- ▶ In case of other directions of movement it should be tested before whether safe switching is guaranteed.

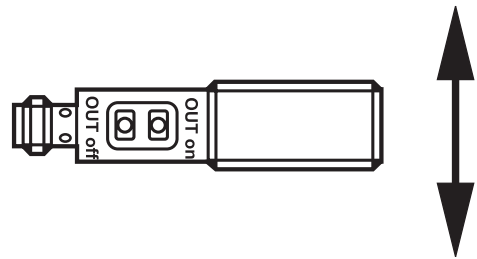

5 Electrical connection



The unit must be connected by a qualified electrician.

- ▶ The national and international regulations for the installation of electrical equipment must be adhered to.
 - ▶ Voltage supply according to EN 50178.
- ▶ Disconnect power.
- ▶ Connect the unit as follows:

DC PNP

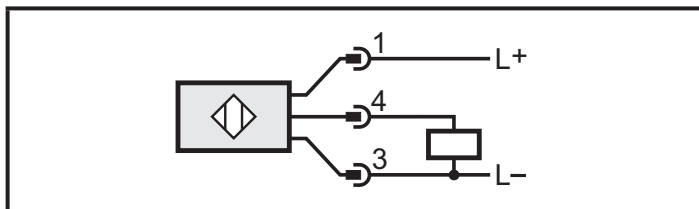

- pin 1 = L+ (10...36 V DC)
- pin 3 = L-
- pin 4 = load (200 mA)
- (pin 2 = not connected)

DC NPN

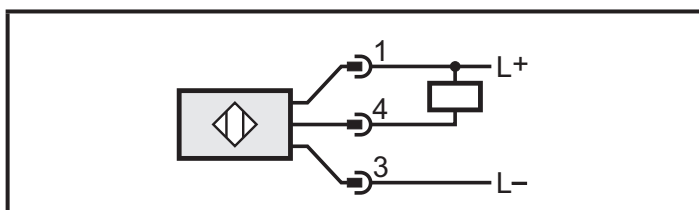

- pin 1 = L+ (10...36 V DC)
- pin 3 = L-
- pin 4 = load (200 mA)
- (pin 2 = not connected)

6 Settings

6.1 The sensor is to switch when the object is detected

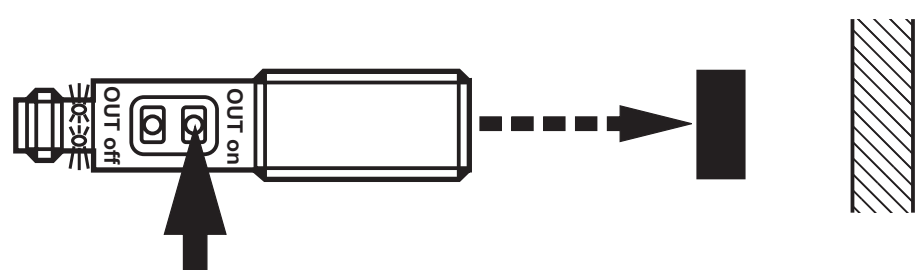
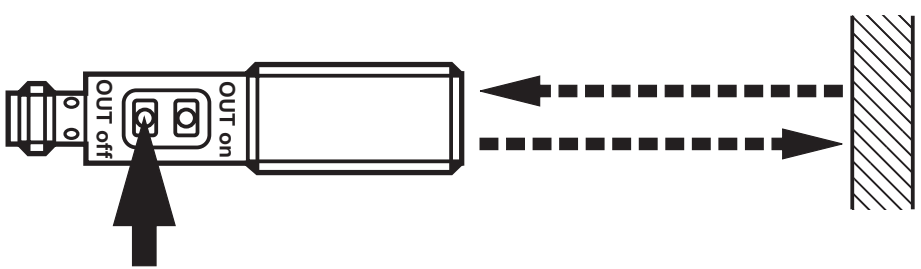
1	<p>▶ Position the object</p> 
	<p>▶ Press [OUT on] for 2 s.</p> <ul style="list-style-type: none">> The sensitivity is set to the object.> The LED flashes.
2	<p>▶ Remove the object</p> 
	<p>▶ Press [OUT off].</p> <ul style="list-style-type: none">> The sensitivity is set without object.> The LED goes out. The programming is finished.

6.2 The sensor is not to switch when the object is detected

- ▶ Position the object (see figure 1) and press [OUT off] for 2 s.
- ▶ Remove the object (see figure 2) and press [OUT on].

The setting can also be carried out first without object and then with object.

6.3 Setting of the maximum sensitivity

- ▶ Align the sensor so that no light is reflected.

The sensor is to switch when the object is detected

- ▶ First press [OUT on], then [OUT off].

The sensor is to switch when the object is not detected

- ▶ First press [OUT off], then [OUT on].

6.4 Programming unsuccessful

- > The LED flashes quickly, 8 Hz.

- Measured value difference too small
- Max. programming time (15 min.) exceeded.

6.5 Electronic lock

Lock or unlock the buttons

- ▶ Press [OUT on] and [OUT off] simultaneously for 10 s.
- > Acknowledgement is indicated by a change of the LED status.

7 Operation

- ▶ Check whether the unit operates correctly.
- > The LED lights when the switching output is switched.

8 Maintenance, repair and disposal

- ▶ Keep the front pane of the sensor free from soiling.
- ▶ For cleaning do not use any solvents or cleaning agents which could damage the plastic material.
- ▶ Do not try to open the module enclosure. There are no user - serviceable components inside.

Technical data and further information at
www.ifm.com → Select your country → Data sheet direct: