

**ODSL 96**

**Optical laser distance sensors**

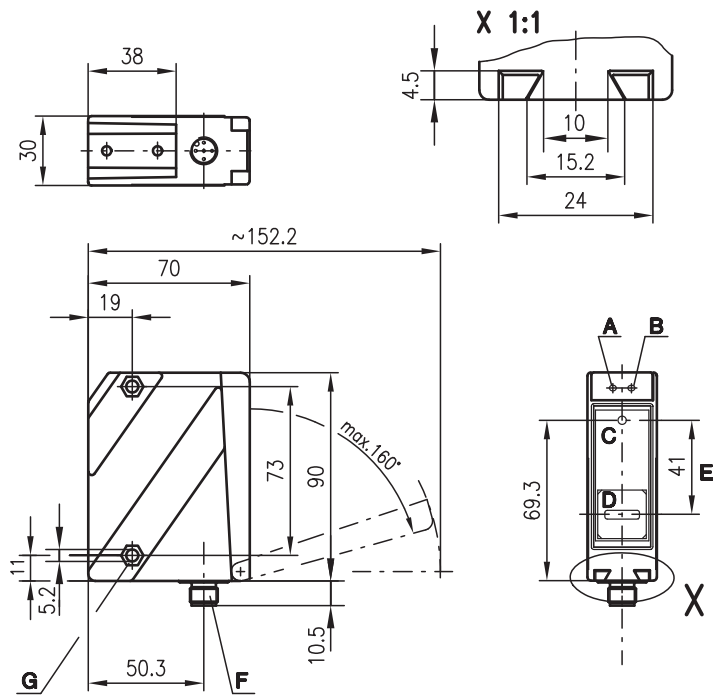

**Dimensioned drawing**



- A Green indicator diode
- B Indicator diode yellow
- C Transmitter
- D Receiver
- E Optical axis
- F Device plug M12x1
- G Countersinking for SK nut M5, 4.2mm deep
- H Teach button

**Electrical connection**

ODSL 96K/V66-2300-S12

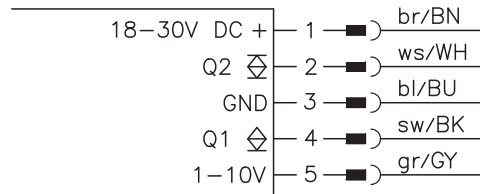

en 08-2014/07 50103924-02

We reserve the right to make changes • DS\_ODSL96K/V66-2300\_en\_50103924\_02.fm

**150 ... 2300mm**  
**18 - 30 V DC**  
**T<sub>I</sub>**

- Reflection-independent distance information
- Analog voltage output 1 ... 10V (can be inverted, teachable)
- 2 teachable switching outputs (push-pull)
- Easy alignment through visible red light

**Accessories:**

(available separately)

- Mounting systems
- Cable with M12 connector (K-D ...)

## Specifications

### Optical data

Measurement range <sup>1)</sup>	150 ... 2300mm
Resolution <sup>2)</sup>	1 ... 5mm
Light source	laser
Wavelength	650nm (visible red light)
Max. output power	<1.2 mW
Pulse duration	4ms
Light spot	divergent, 3x8mm <sup>2</sup> at 2300mm

### Error limits (relative to measurement distance)

Absolute measurement accuracy <sup>1)</sup>	± 3%
Repeatability <sup>3)</sup>	± 2%
B/W detection thresh. (6 ... 90% rem.)	≤ 1%
Temperature drift	≤ 0.1%/°C

### Timing

Measurement time	2 ... 7ms
Response time	≤ 20ms
Delay before start-up	≤ 300ms

### Electrical data

Operating voltage $U_B$	18 ... 30VDC (incl. residual ripple)
Residual ripple	≤ 15% of $U_B$
Open-circuit current	≤ 150mA
Switching output/function <sup>4)</sup>	2 push-pull switching outputs pin 2: Q2, PNP light switching, NPN dark switching pin 4: Q1, PNP light switching, NPN dark switching
Signal voltage high/low	≥ ( $U_B - 2V$ ) / ≤ 2V
Analog output	voltage 1 ... 10V, $R_L$ ≥ 2kΩ

### Indicators

Green LED	continuous light flashing (no teach) off	ready fault, teach values were not applied no voltage
Yellow LED	continuous light flashing (no teach) off	object within teach-in measurement distance (output Q1 <sup>5)</sup> ) teach values were not applied object outside teach-in measurement distance (output Q1 <sup>4)</sup> )

### Mechanical data

Housing	plastic
Optics cover	plastic
Weight	140g
Connection type	M12 connector

### Environmental data

Ambient temp. (operation/storage)	-20°C ... +40°C / -30°C ... +70°C
Protective circuit <sup>6)</sup>	1, 2, 3
VDE safety class <sup>7)</sup>	II, all-insulated
Protection class	IP 67
Laser class	2 (acc. to EN 60825-1)
Standards applied	IEC 60947-5-2

- 1) Luminosity coefficient 6% ... 90%, at 20°C, measurement object ≥ 50x50mm<sup>2</sup>
- 2) Minimum and maximum value depend on measurement distance and configuration of the analog output
- 3) Same object, identical environmental conditions, measurement object ≥ 50x50mm<sup>2</sup>
- 4) The push-pull switching outputs must not be connected in parallel
- 5) No display for output Q2
- 6) 1=transient protection, 2=polarity reversal protection, 3=short circuit protection for all outputs
- 7) Rating voltage 250VAC

Characteristic curve of analog output:

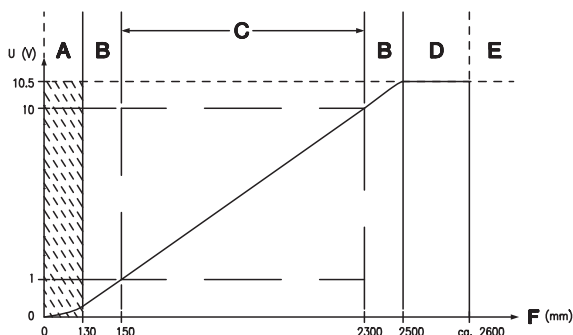

- A Area not defined
- B Linearity not defined
- C Measurement range
- D Object present
- E No object detected
- F Measurement distance

## Order guide

	Designation	Part no.
With M12 connector and analog output	ODSL 96K/V 66-2300-S12	50101881

## Tables

## Diagrams

Characteristic curve of switching outputs:

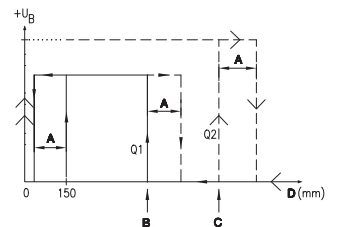

- A Hysteresis
- B Switching point Q1 (teach point)
- C Switching point Q2 (teach point)
- D Measurement distance

## Remarks

### Intended use:

The ODSL 96 distance sensors are optoelectronic sensors for the optical, contactless measurement of distance to objects.

### Operate in accordance with intended use!

- ☞ This product is not a safety sensor and is not intended as personnel protection.
- ☞ The product may only be put into operation by competent persons.
- ☞ Only use the product in accordance with the intended use.

- Measurement time depends on the reflectivity of the measurement object and on the measurement mode.

**Laser safety notices**

**ATTENTION, LASER RADIATION – LASER CLASS 2**

**Never look directly into the beam!**

The device fulfills the EN 60825-1:2008-05 (IEC 60825-1:2007) safety regulations for a product in **laser class 2** as well as the U.S. 21 CFR 1040.10 regulations with deviations corresponding to "Laser Notice No. 50" from June 24th, 2007.

- ↳ Never look directly into the laser beam or in the direction of reflecting laser beams!  
If you look into the beam path over a longer time period, there is a risk of injury to the retina.
- ↳ Do not point the laser beam of the device at persons!
- ↳ Intercept the laser beam with an opaque, non-reflective object if the laser beam is accidentally directed towards a person.
- ↳ When mounting and aligning the device, avoid reflections of the laser beam off reflective surfaces!
- ↳ **CAUTION!** Use of controls or adjustments or performance of procedures other than specified herein may result in hazardous light exposure.  
The use of optical instruments or devices (e.g., magnifying glasses, binoculars) with the product will increase eye hazard.
- ↳ Adhere to the applicable legal and local regulations regarding protection from laser beams acc. to EN 60825 (IEC 60825) in its latest version.
- ↳ The device must not be tampered with and must not be changed in any way.  
There are no user-serviceable parts inside the device.  
Repairs must only be performed by Leuze electronic GmbH + Co. KG.

**NOTICE**

**Affix laser information and warning signs!**

Laser information and warning signs are affixed to the device (see ①). In addition, self-adhesive laser information and warning signs (stick-on labels) are supplied in several languages (see ②).

- ↳ Affix the laser information sheet with the language appropriate for the place of use to the device.  
When using the device in the US, use the stick-on label with the "Complies with 21 CFR 1040.10" notice.
- ↳ Affix the laser information and warning signs near the device if no signs are attached to the device (e.g. because the device is too small) or if the attached laser information and warning signs are concealed due to the installation position.  
Affix the laser information and warning signs so that they are legible without exposing the reader to the laser radiation of the device or other optical radiation.

①



**A** Laser exit opening  
**B** Laser warning sign

②

**50101928-02**

**LASERSTRAHLUNG  
NICHT IN DEN STRAHL BLICKEN**

Max. Leistung (peak): 1,2 mW  
Impulsdauer: 4 ms  
Wellenlänge: 650 nm

**LASER KLASSE 2  
DIN EN 60825-1:2008-05**

**RADIAZIONE LASER  
NON FISSARE IL FASCIO**

Potenza max. (peak): 1,2 mW  
Durata dell'impulso: 4 ms  
Lunghezza d'onda: 650 nm

**APPARECCHIO LASER DI CLASSE 2  
EN 60825-1:2007**

**LASER RADIATION  
DO NOT STARE INTO BEAM**

Maximum Output (peak): 1,2 mW  
Pulse duration: 4 ms  
Wavelength: 650 nm

**CLASS 2 LASER PRODUCT  
EN 60825-1:2007**

**RAYONNEMENT LASER  
NE PAS REGARDER DANS LE FASCIEAU**

Puissance max. (crête): 1,2 mW  
Durée d'impulsion: 4 ms  
Longueur d'onde: 650 nm

**APPAREIL A LASER DE CLASSE 2  
EN 60825-1:2007**

**AVOID EXPOSURE – LASER RADIATION  
IS EMITTED FROM THIS APERTURE**

**EXPOSITION DANGEREUSE – UN RAYONNEMENT  
LASER EST EMIS PAR CETTE OUVERTURE**

**RADIACION LASER  
NO MIRAR FIJAMENTE AL HAZ**

Potencia máx. (peak): 1,2 mW  
Duración del impulso: 4 ms  
Longitud de onda: 650 nm

**PRODUCTO LASER DE CLASE 2  
EN 60825-1:2007**

**RADIAÇÃO LASER  
NÃO OLHAR FIXAMENTE O FEIXE**

Potência máx. (peak): 1,2 mW  
Período de pulso: 4 ms  
Comprimento de onda: 650 nm

**EQUIPAMENTO LASER CLASSE 2  
EN 60825-1:2007**

**LASER RADIATION  
DO NOT STARE INTO BEAM**



Maximum Output (peak): 1,2 mW  
Pulse duration: 4 ms  
Wavelength: 650 nm

**CLASS 2 LASER PRODUCT  
EN 60825-1:2007  
Complies with 21 CFR 1040.10**

**激光辐射  
勿直视光束**

最大输出 (峰值): 1,2 mW  
脉冲持续时间: 4 ms  
波长: 650 nm

**2 类激光产品  
GB7247.1-2012**





## T<sub>1</sub> teach-in with teach button

1. Position measurement object at the desired measurement distance (①).

2. The respective teach function is activated by operating the teach button (②) for different amounts of time. The activated teach function is signaled by a flashing of the LEDs.

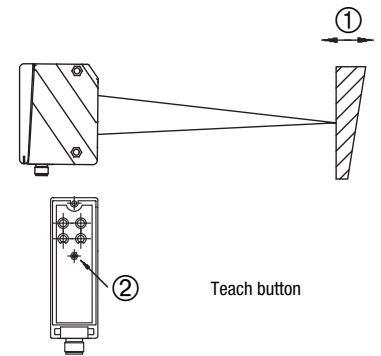
Teach function	Duration of teach button operation	Green LED	Yellow LED
Switching output Q1	2 ... 4s	Flash synchronously	
Switching output Q2	4 ... 6s	Flash alternatingly	
1V analog output	6 ... 8s	On	Flashes
10V analog output	8 ... 10s	Flashes	On



3. Release teach button (②) and wait for optical confirmation by end of flashing signal (green LED on).

## Reset of the analog output to factory settings

### Reset 1V analog output at 150mm:

1. Position measurement object just below start of measurement range (150mm).
2. Press teach button for 6 ... 8s (green LED on, yellow LED flashes).
3. Release teach button and wait for optical confirmation by end of flashing signal (green LED on).

### Reset 10V analog output at 2300mm:

1. Position measurement object just beyond end of measurement range (2300mm).
2. Press teach button for 8 ... 10s (green LED flashes, yellow LED on).
3. Release teach button and wait for optical confirmation by end of flashing signal (green LED on).

## Error messages

Continuously flashing LEDs signal an unsuccessful teach event (sensor not ready):

Green LED	Yellow LED	Error
Flash synchronously		Teach switching output Q1 unsuccessful
Flash alternatingly		Teach switching output Q1 unsuccessful
On	Flashes	Teach 1V analog output unsuccessful
Flashes	On	Teach 10V analog output unsuccessful

Remedy:

- Repeat teach event or
- Press teach button for more than 10s or
- Disconnect sensor from voltage to restore the old values.

**Typical areas of application of optical distance sensors**

Continuous distance measurement

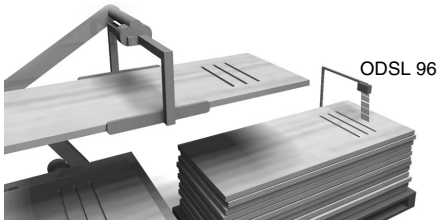

Positioning tasks

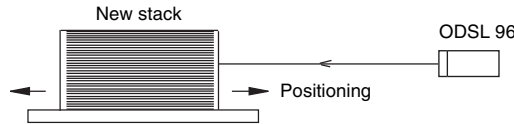

Filling level control

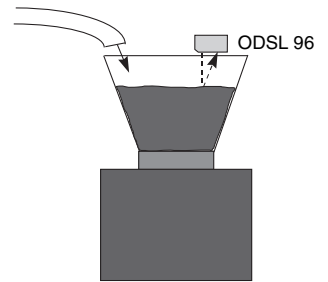

**Installation instructions**

Mounting systems are available which have to be ordered separately at Leuze electronic. Apart from this, the drilled-through holes and threaded holes are suitable for the individual mounting of the ODSL 96, depending on the area in which it is used. When mounting, avoid application of excessive force on the housing.

Preferred movement of the objects

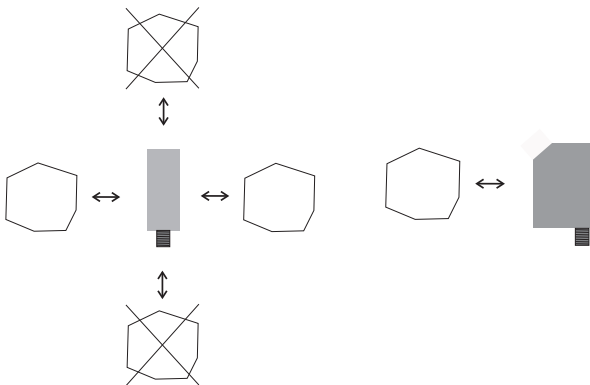

Preferred mounting in connection to objects with structured surface

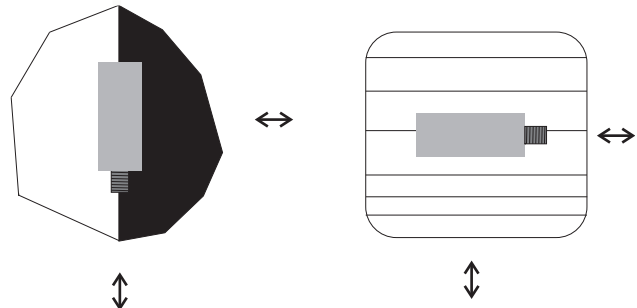

**View through a chase**

If the ODSL 96 has to be installed behind a cover, the chase has to have at least the size of the optical glass cover. Otherwise, a correct measurement is not possible or can not be guaranteed.

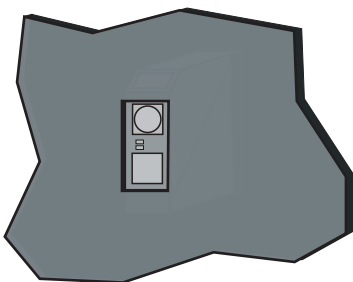

**Alignment to measurement objects with reflecting surfaces**

If the measurement object to be detected has a reflecting surface, a measurement may not be possible depending on the angle in which the light is reflected by the measurement object's surface. Adjust the angle between the sensor and the measurement object such that the sensor can reliably detect the measurement object.

