



ODS 10 Laser distance sensor



© 2015

Leuze electronic GmbH + Co. KG

In der Braike 1

D-73277 Owen / Germany

Phone: +49 7021 573-0

Fax: +49 7021 573-199

<http://www.leuze.com>

info@leuze.de

1	About this document	5
1.1	Used symbols and signal words	5
1.2	Important terms	6
2	Safety	7
2.1	Intended use	7
2.2	Foreseeable misuse	7
2.3	Competent persons	7
2.4	Exemption of liability	8
2.5	Laser safety notices	8
3	Device description	9
3.1	Device overview	9
3.1.1	General information	9
3.1.2	Operating principle	9
3.1.3	Performance characteristics	10
3.1.4	Accessories	10
3.2	Connection technology	10
3.3	Indicators and operational controls	11
3.3.1	LED indicators	11
3.3.2	Control buttons	11
3.3.3	Display	12
3.3.4	Meaning of the display icons	12
3.4	Configuration / menu structure	13
3.4.1	Input menu	13
3.4.2	Menu Output Q1	14
3.4.3	Menu Output Q2	14
3.4.4	Analog Output menu	15
3.4.5	Application menu	16
3.4.6	Settings menu	17
3.5	Configuration example	17
4	Function and applications	20
4.1	Push-through protection	20
4.2	Collision protection	21
4.3	Stack height measurement	22
4.4	Loop measurement	23
5	Mounting	24
5.1	Mounting with mounting system	24
5.2	BPS mounting with M4 fastening screws	24
6	Electrical connection	25
6.1	Overview	25
6.2	Pin assignment	25
7	Commissioning – sensors with analog interface	28
7.1	Setting the analog output	28
7.1.1	Configuring the analog output	28
7.1.2	Teaching the analog output	29
7.2	Setting the switching outputs	30
7.2.1	Configuring switching outputs	30
7.2.2	Teaching the switching outputs	30

7.3	Setting measure mode	32
7.4	Reset to factory settings	32
8	Commissioning – sensors with IO-Link interface	33
8.1	Overview	33
8.2	IO-Link process data	33
9	Connecting to a PC – <i>Sensor Studio</i>	34
9.1	System requirements	34
9.2	Installing <i>Sensor Studio</i> configuration software and IO-Link USB master	35
9.2.1	Downloading configuration software	35
9.2.2	Installing the <i>Sensor Studio</i> FDT frame	35
9.2.3	Installing drivers for IO-Link USB master	36
9.2.4	Connecting IO-Link USB master to the PC	36
9.2.5	Connecting IO-Link USB master to the sensor	36
9.2.6	Installing the DTM and IODD	37
9.3	Starting the <i>Sensor Studio</i>	37
9.4	Short description of the <i>Sensor Studio</i> configuration software	39
9.4.1	FDT frame menu	40
9.4.2	<i>IDENTIFICATION</i> function	40
9.4.3	<i>CONFIGURATION</i> function	41
9.4.4	<i>PROCESS</i> function	42
9.4.5	<i>DIAGNOSIS</i> function	44
9.4.6	Exiting <i>Sensor Studio</i>	44
10	Troubleshooting	45
10.1	What to do in case of failure?	45
10.2	LED indicators	45
10.3	Indicators in the display	45
11	Care, maintenance and disposal	47
11.1	Cleaning	47
11.2	Servicing	47
11.3	Disposing	47
12	Service and support	48
12.1	What should I do if service is required?	48
13	Technical data	49
13.1	General specifications	49
13.2	Dimensioned drawings	51
13.3	Dimensioned drawings: Accessories	52
14	Ordering information and accessories	53
14.1	Type overview ODS 10	53
14.2	Accessories – cables and connectors	54
14.3	Other accessories	54
14.3.1	Accessories – PC connection	55
15	EC Declaration of Conformity	56

1 About this document

1.1 Used symbols and signal words

Table 1.1: Warning symbols and signal words



	Symbol indicating dangers to persons
	Symbol indicating dangers from harmful laser radiation
NOTICE	Signal word for property damage Indicates dangers that may result in property damage if the measures for danger avoidance are not followed.
CAUTION	Signal word for minor injury Indicates dangers that may result in minor injury if the measures for danger avoidance are not followed.

Table 1.2: Other symbols



	Symbol for tips Text passages with this symbol provide you with further information.
	Symbols for action steps Text passages with this symbol instruct you to perform actions.

Table 1.3: Terms and abbreviations

DTM	Device Type Manager Software device manager of the sensor
FDT	Field Device Tool Software frame for management of device managers (DTM)
FE	Functional earth
NEC	National Electric Code
IODD	IO Device Description File with information on process data and device parameters
ODS	Optical Distance Sensor
OLED	Organic Light Emitting Diode Organic LED
PELV	Protective Extra Low Voltage Protective extra low voltage with reliable disconnection
TOF	Time-of-Flight Distance measurement procedure using the propagation time of the signal
UL	Underwriters Laboratories

1.2 Important terms

Table 1.4: Important terms

Accuracy	The possible divergence of the measurement value from the anticipated value through changes in the environmental conditions during the measuring process. Accuracy is increased under constant environmental conditions.
Resolution	The smallest possible distance change of the measurement object, which causes a definite change in the output signal.
Warmup time	Time the sensor needs in order to reach the operating temperature. An optimal measurement is only possible after the end of the warmup time. The warmup time is approximately 20 minutes.
Output resolution	The output resolution describes how the measurement values are presented on the display and digital interfaces. The output resolution of the ODS 10 is 1 mm and cannot be changed.
Delay before start-up	The delay before start-up indicates the point in time when the first valid measurement can be obtained after switching on.
Light switching Dark switching	The behavior of the switching output if an object is within the taught/ configured switching distance. <ul style="list-style-type: none"> • Light switching: switching output active (high) • Dark switching: switching output not active (low)
Measurement time	The measurement time indicates the time difference between two consecutive measurements.
Diffuse reflection	Return and/or degree of reflection of the radiated light. In the case of sensors with the time-of-flight measurement principle, the measurement range depends on the reflectance. Observe the specifications regarding diffuse reflection; see chapter 13 "Technical data". <ul style="list-style-type: none"> • 90 % is white • 6 % is black
Time-of-Flight	Distance measurement procedures that determines the distance of an object via the propagation time of a light pulse emitted by the sensor's transmitter that is reflected by the object and received by the sensor's receiver.
Reproducibility	Deviation of the measurement value if the measurement is repeated under the same initial conditions.

2 Safety

This sensor was developed, manufactured and tested in line with the applicable safety standards. It corresponds to the state of the art.

2.1 Intended use

The device is designed as an optoelectronic sensor for the optical, contactless measurement of the distance to objects.

Areas of application

The laser distance sensor is designed for the following areas of application:

- High-bay storage device: push-through protection
- Crane: collision protection
- Stack height measurement
- Loop measurement

 **CAUTION**

Observe intended use!

↳ Only operate the device in accordance with its intended use.

The protection of personnel and the device cannot be guaranteed if the device is operated in a manner not complying with its intended use.

Leuze electronic GmbH + Co. KG is not liable for damages caused by improper use.

↳ Read these original operating instructions before commissioning the device.

Knowledge of the original operating instructions is an element of proper use.

NOTICE

Comply with conditions and regulations!

↳ Observe the locally applicable legal regulations and the rules of the employer's liability insurance association.

2.2 Foreseeable misuse

Any use other than that defined under "Intended use" or which goes beyond that use is considered improper use.

In particular, use of the device is not permitted in the following cases:

- In rooms with explosive atmospheres
- In circuits which are relevant to safety
- Operation for medical purposes

NOTICE

Do not modify or otherwise interfere with the device!

↳ Do not carry out modifications or otherwise interfere with the device.

The device must not be tampered with and must not be changed in any way.

The device must not be opened. There are no user-serviceable parts inside.

Repairs must only be performed by Leuze electronic GmbH + Co. KG.

2.3 Competent persons

Connection, mounting, commissioning and adjustment of the device must only be carried out by competent persons.

Prerequisites for competent persons:

- They have a suitable technical education.
- They are familiar with the rules and regulations for occupational safety and safety at work.
- They are familiar with the original operating instructions of the device.
- They have been instructed by the responsible person on the mounting and operation of the device.

Certified electricians

Electrical work must be carried out by a certified electrician.

Due to their technical training, knowledge and experience as well as their familiarity with relevant standards and regulations, certified electricians are able to perform work on electrical systems and independently detect possible dangers.

In Germany, certified electricians must fulfill the requirements of accident-prevention regulations BGV A3 (e.g. electrician foreman). In other countries, there are respective regulations that must be observed.

2.4 Exemption of liability

Leuze electronic GmbH + Co. KG is not liable in the following cases:

- The device is not being used properly.
- Reasonably foreseeable misuse is not taken into account.
- Mounting and electrical connection are not properly performed.
- Changes (e.g., constructional) are made to the device.

2.5 Laser safety notices

 **ATTENTION, LASER RADIATION – LASER CLASS 1**

The device fulfills the IEC 60825-1:2007 (EN 60825-1:2007) requirements for a product in **laser class 1** as well as the U.S. 21 CFR 1040.10 regulations with deviations corresponding to “Laser Notice No. 50” from June 24th, 2007.

- ↳ Observe the applicable statutory and local laser protection regulations.
- ↳ The device must not be tampered with and must not be changed in any way.

There are no user-serviceable parts inside the device.

Repairs must only be performed by Leuze electronic GmbH + Co. KG.

3 Device description

3.1 Device overview

3.1.1 General information

The laser distance sensor is an optical distance sensor that operates according to the time-of-flight measurement procedure.

The sensor consists of the following components:

- Transmitter: laser spot
- Receiver
- White OLED display
- Control panel with membrane keyboard
- Status LEDs
- Connection for connecting to the control: M12 connector or cable outlet with open cable end or M12 connector

The sensor can be configured using display and control buttons.

With the *Sensor Studio* configuration software, the sensors can be configured via the IO-Link interface with a PC and the measurement values visualized. Stored parameter sets can be duplicated in other sensors. The connection is made via the IO-Link USB master, which is available as an accessory.

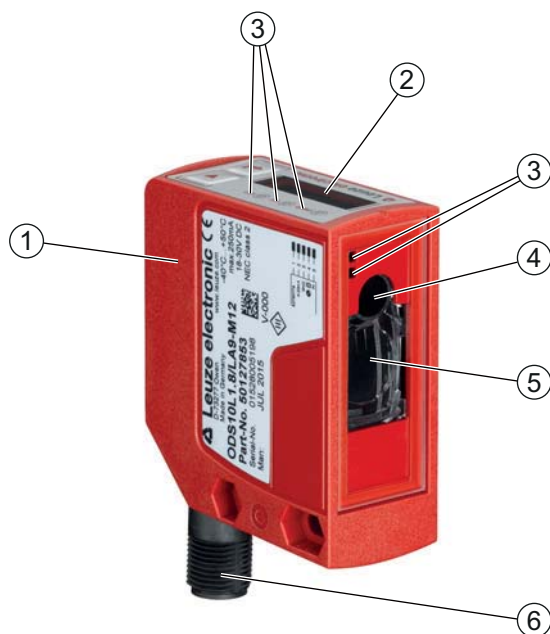

- 1 Device housing
- 2 Display and control panel
- 3 Status LEDs
- 4 Transmitter
- 5 Receiver
- 6 Connection

Figure 3.1: Device construction

3.1.2 Operating principle

Time-of-flight measurement procedure

The laser distance sensor determines the distance of an object via the propagation time of a light pulse emitted by the sensor's transmitter that is reflected by the object and received by the sensor's receiver. The measurement time is set via the display and control panel or by means of configuration software.

Advantages of the time-of-flight measurement principle:

- Large measurement range
- Low influence of gloss and structures on the measurement value

3.1.3 Performance characteristics

The most important performance characteristic of the ODS 10 laser distance sensor:

- Large measurement range
 - 50 mm ... 8000 mm against objects (90% diffuse reflection)
 - 100 mm ... 25000 mm using reflective tape
- Analog current and voltage output (configurable)
Factory setting: current output
- OLED display and membrane keyboard for configuration
- Configurable measurement range and measure mode
- Measurement value display in mm on OLED display
- IO-Link version 1.1
- Optional: multifunction input for deactivating the laser or for teaching the digital switching points (teach-in)
Factory setting: input for deactivating the laser
- Optional: second switching output

For measurement against objects:

- Measurement range: 50 ... 8000 mm
- Measurement against diffusely reflective objects
- Reflection-independent distance information
- Applications:
 - High-bay storage device: push-through protection
 - Crane: collision protection
 - Stack height measurement
 - Loop measurement

For measurement against reflective tape (ODS 10L1-25M*):

- Measurement range: 100 ... 25000 mm
- Applications:
Positioning of, e.g., side-tracking skates and cranes

3.1.4 Accessories

Special accessories are available for the laser distance sensor; see chapter 14:

- Mounting systems for mounting on rods
- Connection cables
- Reflective tape
- IO-Link USB master set for connecting to a PC

3.2 Connection technology

For the electrical connection of the laser distance sensor, the following connection variants are available:

- M12 connector, 5-pin
- Connection cable, 2000 mm, 5-wire
- Connection cable, 200 mm, with M12 connector, 5-pin

3.3 Indicators and operational controls

The device housing is provided with the following indicators and operational controls:

- OLED display
- Two control buttons
- Green/red LED on the control panel
- Two yellow LEDs:
 - On the control panel
 - On the lens cover



Sensors with a second switching output (designation: ODS10L1.8/LA6) are provided with a second yellow LED on both the control panel and on the lens cover as switching state display for switching output Q2.

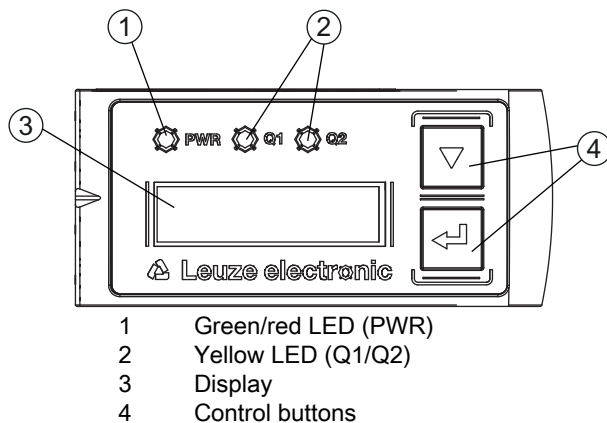

Figure 3.2: Indicators and operational controls

3.3.1 LED indicators

Table 3.1: Meaning of the LED indicators on the device housing

LED	Color, state	Description
Green/red LED PWR	Green	Sensor ready
	Orange	Warning, weak signal
	Red	No signal
	Off	No supply voltage
Yellow LED Switching output Q1/Q2	On	Object detected in the switching range
	Off	No object detected in the switching range

3.3.2 Control buttons

The sensor is configured via the display and control buttons. The display is controlled via the control buttons. You can make adjustments in the application via the control buttons.

- ▼ – Scroll through the functions
- ↵ – Enter button: select function, confirm/enter value

The ▼ and ↵ buttons have different functions depending on the operating situation. These functions are displayed via icons at the right edge of the display; see chapter 3.3.4 "Meaning of the display icons".

Navigating within the menus

Use the navigation button ▼ to move through the menu.
 Activate the desired selection with the enter button ↵.

The number of bars at the left edge of the display indicates the current menu level.

Selecting options

Set the desired option with the navigation button ▼ and the enter button ↵.

Reset to factory settings

↵ While switching on the supply voltage, press the enter button ↵ to reset the sensor configuration to the factory settings.

↵ Press the enter button ↵ again to reset all parameters to factory settings. All parameter settings made previously are permanently lost.

Press the navigation button ▼ to return to process mode without resetting the parameters.



You can also use the menu (see chapter 3.4 "Configuration / menu structure") or the *Sensor Studio* configuration software to reset to factory settings (see chapter 9 "Connecting to a PC – Sensor Studio").

3.3.3 Display

The display changes depending on the current operating mode. The following display modes exist:

- Menu display

Press one of the two control buttons to access the menu display.

For information on operating via the menu, see chapter 3.4 "Configuration / menu structure" and see chapter 3.5 "Configuration example".

- Process mode

After switching on the supply voltage and error-free initialization of the device, the green LED lights up continuously. The laser distance sensor is in process mode.

In process mode, the current measurement value is displayed in the display, e.g. "255mm".



In the menu display, the selectable or editable values are shown with inverted text colors (black on white background).

If no button is pressed in the configuration menu within 120 s, the brightness is then reduced. If no button is pressed in the following 60 s, the sensor automatically returns to process mode.

The sensor can be protected against unauthorized configuration change by activating the password query (see chapter 3.4.6 "Settings menu"). The password is permanently set to **165**.









Status displays in process mode

The display shows the following status displays:

- Object distance in mm
- ⚠: weak reception signal
- "No Signal": no object detected or reception signal too weak
- "Signal Error", wrench icon: signal failure or sensor defective
- Box symbol/crossed out with X: laser deactivated
- Arrow pointing downward: the current measurement value is lower than the lower limit of the analog output.
- Arrow pointing upward: the current measurement value is larger than the upper limit of the analog output.

3.3.4 Meaning of the display icons



The ▼ and ↵ buttons have different functions depending on the operating situation. These functions are displayed via icons at the right edge of the display.

Icon	Position	Function
	First line	By pressing the navigation button ▼ you select the next parameter within a menu level.
	First line	Symbolizes that you have reached the lowest menu level.
	Second line	Symbolizes the respective, next menu level that you have not yet selected.
	Second line	Press the enter button ↵ to exit the menu level or the menu.
	Second line	Symbolizes the input mode. The selected (highlighted) option field can be a fixed selection parameter or a multi-digit input field. With a multi-digit input field, you can increase the active digit by one with the navigation button ▼ and use the enter button ↵ to switch from one digit to the next.
	Second line	Confirmation of the selection. This icon appears when you complete an option field with the enter button ↵.
	Second line	Reject the selection. This icon is accessed from the previous icon (check mark) by pressing the navigation button ▼. Press the enter button ↵ to reject the current value or option parameter.
	Second line	Return to selection. This icon is accessed from the previous icon (cross) by pressing the navigation button ▼. Press the enter button ↵ to reset the current value or option parameter and enter a new value or select a new option parameter.

3.4 Configuration / menu structure

The following chapters show the structure of all menu items. For each sensor model, only the actually available menu items are present for entering values or for selecting settings.

-  Use the navigation button ▼ to move through the menu.
-  Activate the desired selection with the enter button ↵.

-  The number of bars at the left edge of the display indicates the current menu level.
-  For information on the meaning of the display icons, see chapter 3.3.4.

3.4.1 Input menu

The function of the switching input on pin 5 is set in the **Input** menu.

-  The **Input** menu is only available for sensors with switching input.

Level 1	Level 2	Level 3	Description	Default
Input	Input Mode		Function of the switching input on pin 5 if the supply voltage is applied.	
		Teach	Teach analog output and switching output	
		Deactivation	Switch off laser transmitter with +24 V on the switching input	X
		Activation	Switch on laser transmitter with +24 V on the switching input	

3.4.2 Menu Output Q1

The switching behavior of switching output Q1 on pin 4 is set in the **Output Q1** menu.

Level 1	Level 2	Level 3	Description	Default
Output Q1	Q1 Upper Sw. Pt.		Upper switching point	ODS10L1.8...: 4000 mm ODS10L1-25.8...: 12500 mm
	Q1 Lower Sw. Pt.		Lower switching point	50 mm
	Notice: For the limit values of the measurement range for your sensor, see chapter 13 "Technical data".			
	Q1 Hysteresis		Hysteresis	30 mm
	Q1 Light/Dark		Behavior of the switching output if an object is within the taught/ configured switching distance. <ul style="list-style-type: none"> • Light switching; switching output active (high) • Dark switching; switching output not active (low) 	Light

3.4.3 Menu Output Q2

The switching behavior of switching output Q2 on pin 5 is set in the **Output Q2** menu.



The **Output Q2** menu is only available for sensors with a second switching output Q2.

Level 1	Level 2	Level 3	Description	Default
Output Q2	Q2 Upper Sw. Pt.		Upper switching point	ODS10L1.8...: 4000 mm ODS10L1-25.8...: 12500 mm
	Q2 Lower Sw. Pt.		Lower switching point	50 mm
	Notice: For the limit values of the measurement range for your sensor, see chapter 13 "Technical data".			
	Q2 Hysteresis		Hysteresis	30 mm
	Q2 Light/Dark		Behavior of the switching output if an object is within the taught/ configured switching distance. <ul style="list-style-type: none"> • Light switching; switching output active (high) • Dark switching; switching output not active (low) 	Light

3.4.4 Analog Output menu

The characteristic output curve of the analog switching output on pin 2 is set in the **Analog Output** menu.



The **Analog Output** menu is only available for sensors with analog switching output.

Level 1	Level 2	Level 3	Description	Default
Analog Output	Position Max. Val.		Distance measurement value for maximum voltage / maximum current	Upper limit of the measurement range
	Position Min. Val.		Distance measurement value for minimum voltage / minimum current	50 mm
	Notice: For the limit values of the measurement range for your sensor, see chapter 13 "Technical data".			
	Analog Range	4 - 20 mA 1 - 10 V 0 - 10 V	Current/voltage range of the analog switching output	X

Spreading the characteristic output curve

You can spread the characteristic output curve of the analog switching output according to your requirements.

- ↪ Select the current or voltage range of the analog switching output.
- ↪ Set the distance measurement value that corresponds to the lower limit of the measurement range (4 mA, 1 V, 0 V).
- ↪ Set the distance measurement value that corresponds to the upper limit of the measurement range (20 mA, 10 V).

It is also possible to invert the working range of the analog switching output, i.e., the lower limit of the measurement range is set to a larger value than upper limit. This creates a descending characteristic output curve.

3.4.5 Application menu

The measurement function of the sensor is set in the **Application** menu.

Level 1	Level 2	Level 3	Description	Default
Application	Measure Mode		Measure mode of the sensor	
		Standard	Standard setting	
		Precision	Twice as accurate as the standard setting; two to three times slower	X
		Speed	One third as accurate as the standard setting, approx. six times faster	

In the table, you will find an overview of how the choice of measure mode affects the individual parameters of the measurement function.

Table 3.2: Measure mode and measurement function parameter

Measure mode	Accuracy	Measurement time	Measurement value update
Standard	+	20 ms	+
Precision	++	50 ms	--
Speed	-	3.5 ms	++

3.4.6 Settings menu



You can set the display language and call up information about the sensor in the **Settings** menu.

Level 1	Level 2	Level 3	Description	Default
Settings	Language		Setting of the display language	
		English	Display language English	X
		German	Display language German	
	Display		Display settings	
		On	The display (measurement value display) is always at full brightness.	
		Auto	After pressing a control button, the display is set to full brightness for approx. one minute and then dims.	X
		Auto off	The display (measurement value display) is automatically switched off after 30 minutes.	
		Off	No measurement value display – the display is only active in the menu after pressing a control button.	
	Factory settings		Reset to factory settings	
		Inactive	The sensor is not reset to factory settings.	
		Execute	The sensor is reset to factory settings.	
	Password Check		Locks access to the menu with the fixed password "165"	
		Inactive	Not active	X
		Activated	Active	
	Info		Information on the sensor	
		Part Number	Leuze part number of the sensor	
		Serial No	Serial number of the sensor	
	Firmware Revision	Firmware version		

3.5 Configuration example



To illustrate menu operation, the setting of the lower switching point of switching output Q1 to 100 mm is explained as an example.

↪ In process mode, press a control button to activate the menu display.



Input	
Output Q1	

↪ Press the navigation button ▼.

The display shows "Output Q1" in the upper menu line.



Output Q1	
Output	

↵ Press the enter button  to select Output Q1.

Q1 Upper Sw. Pt.	
08000 mm	



↵ Press the navigation button  once.

The display shows “Q1 Lower Sw. Pt.” in the upper menu line.



Q1 Lower Sw. Pt.	
11016 mm	

↵ Press the enter button  to set the lower switching point.

The first digit of the switching point value is displayed with inverted colors.

Q1 Lower Sw. Pt.	
11016 mm	



↵ Press the navigation button  as many times as necessary to set the desired value “0”.

Q1 Lower Sw. Pt.	
01016 mm	



↵ Press the enter button  to accept the set value.

↵ Repeat the setting for the other digits until the complete value “00100” is set.

Use the enter button  to switch from one digit to the next.

Q1 Lower Sw. Pt.	
00100 mm	



After pressing the enter button ↵ for the fourth time, the  icon appears in the lower right part of the display.

- The  icon indicates that the next time the enter ↵ button is pressed, the set value will be accepted.
- You can change the function of the enter button ↵ by pressing the navigation button ▼ several times. The following icons are displayed in succession:
 -  : re-edit value
 -  : reject value



↵ Press the enter button ↵ to accept the set value “00100”.

“Q1 Lower Sw. Pt.” is displayed inverted in the display.



The newly set value “00100 mm”, which is stored in non-volatile memory, appears in the display.

Q1 Lower Sw. Pt.	
00100 mm	



↵ Press the navigation button ▼ repeatedly until the ← icon appears in the upper menu line.

←	
Q1 Upper Sw. Pt.	

↵ Press the enter button ↵ to access the next-higher menu level.

Output Q2	
Analog Output	

↵ Press the navigation button ▼ repeatedly until ← “Menu Exit” appears in the upper menu line.

← Menu Exit	
Input	

↵ Press the enter button ↵ to exit the menu display and access process mode.

225 mm

4 Function and applications

The laser distance sensor is a distance sensor with an extensive range of applications for intralogistic, industrial and packaging applications.

The laser distance sensor can be used for the following areas of application:

- High-bay storage device: push-through protection; see chapter 4.1
- Crane: collision protection; see chapter 4.2
- Stack height measurement; see chapter 4.3
- Loop measurement; see chapter 4.4

4.1 Push-through protection

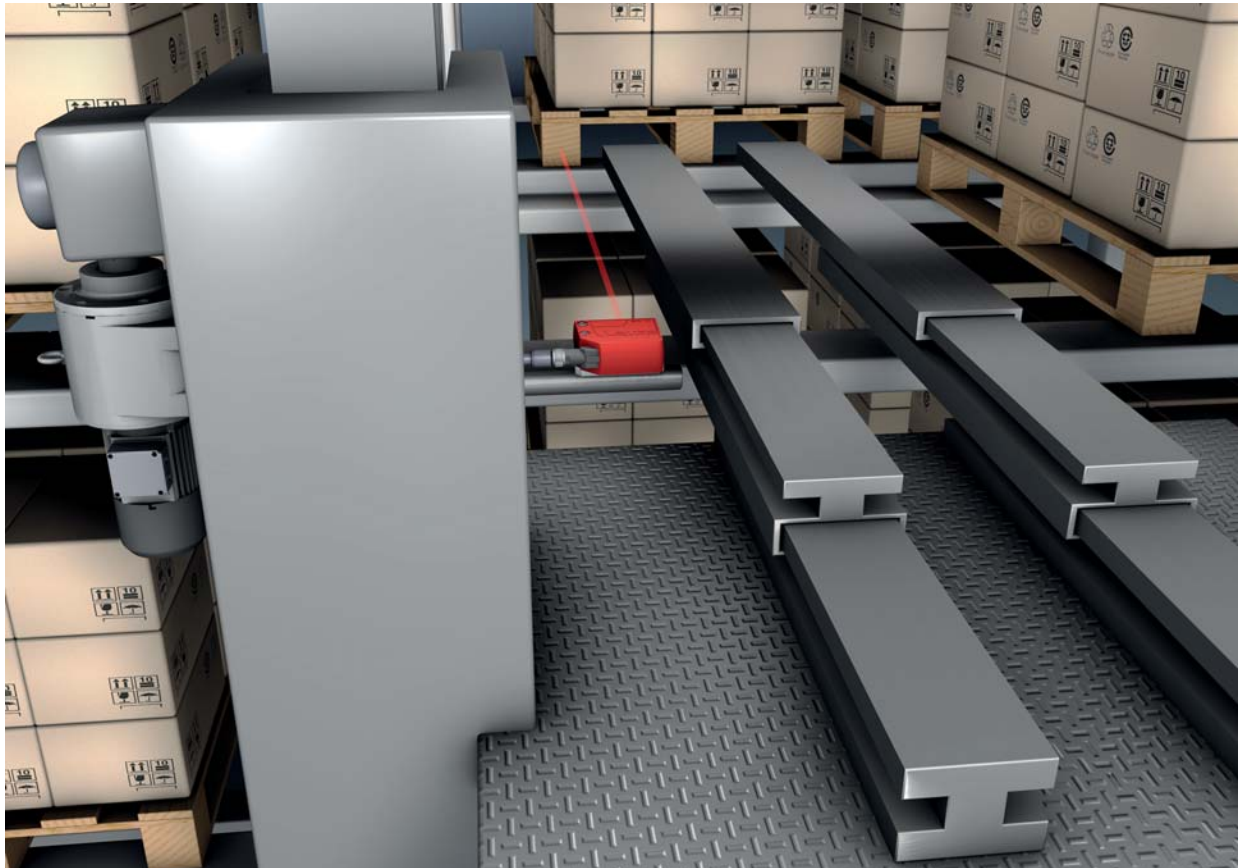

Figure 4.1: High-bay storage device: push-through protection

4.2 Collision protection

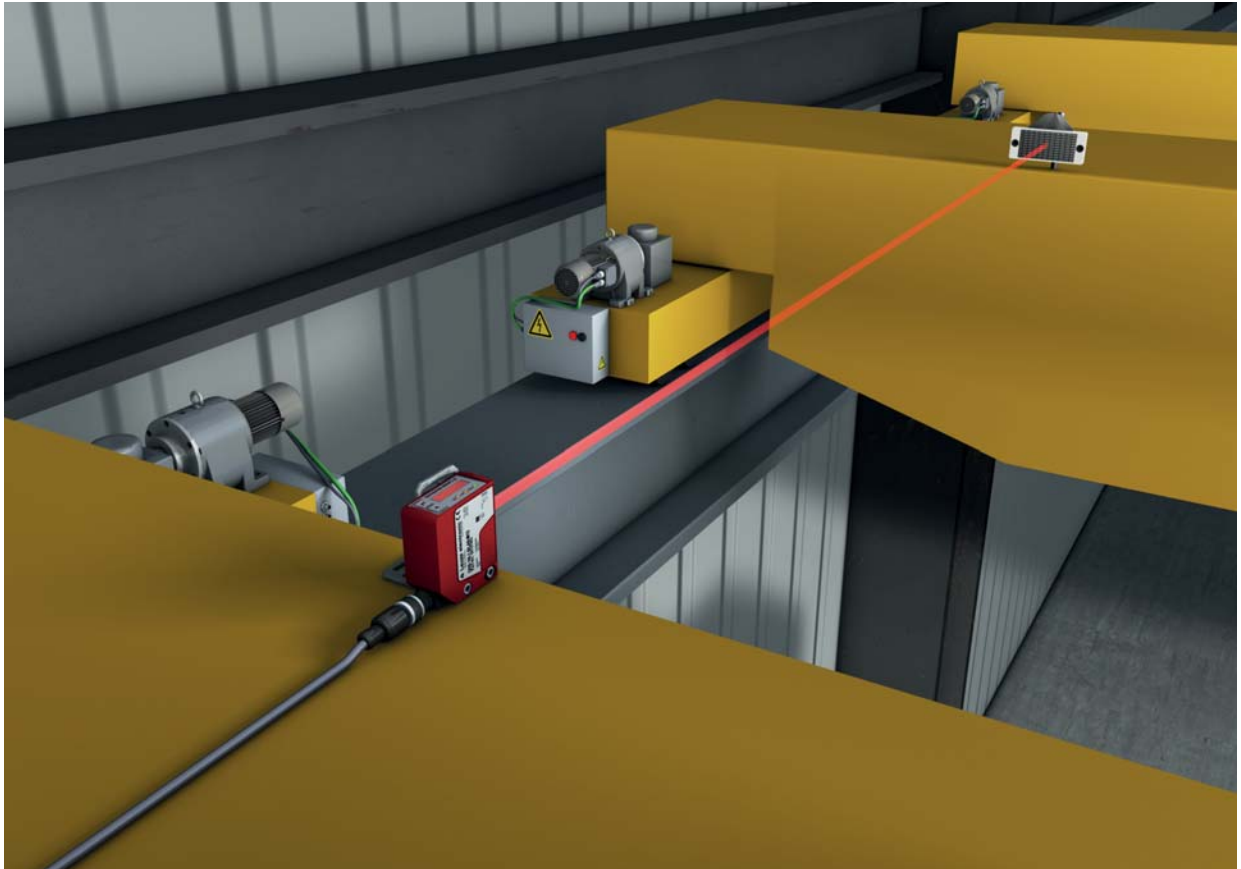

Figure 4.2: Crane: collision protection

- Measurement against reflective tape (ODS 10L1-25M*), 100 mm ... 25000 mm

4.3 Stack height measurement



Figure 4.3: Stack height measurement

4.4 Loop measurement



Figure 4.4: Loop measurement

5 Mounting

The sensor can be mounted in the following ways:

- Mount using a mounting system
 - BTU 300M-D10: mounting on rod \varnothing 10 mm
 - BTU 300M-D12: mounting on rod \varnothing 12 mm
 - BTU 300M-D14: mounting on rod \varnothing 14 mm
- Mount using inlay nuts in the housing for custom mounting depending on the area of application.

NOTICE

Observe during mounting!

- ↪ Make certain that the required environmental conditions (humidity, temperature) are maintained.
- ↪ Make certain that the optics cover of the sensor is not soiled, e.g., by leaking fluids, abrasion from boxes or residues from packaging material.
- ↪ When mounting behind a cover:
Make certain that the cutout in the cover is at least as large as the lens cover of the sensor. Correct measurement cannot otherwise be ensured.

5.1 Mounting with mounting system

Mounting with a mounting system is intended for rod mounting. For ordering information, see chapter 14.3.

- ↪ Mount the mounting system on the rod (system-side).
- ↪ Mount the sensor on the mounting system with M4 fastening screws (not included in delivery contents).
Max. tightening torque of the fastening screws: 1.4 Nm

5.2 BPS mounting with M4 fastening screws

- ↪ Mount the sensor on the machine with M4 fastening screws (not included in delivery contents).
Max. tightening torque of the fastening screws: 1.4 Nm



For space-saving installation of the sensor, both sides of the housing are provided with recesses for M4 inlay nuts. Depth of the recesses: 4.2 mm.

6 Electrical connection

6.1 Overview

The assignment of the electrical connections is dependent on the type of sensor that is used. The type designation of the sensor is specified on the name plate.

 CAUTION
Safety Notices! <ul style="list-style-type: none"> ↳ Before connecting the device, be sure that the supply voltage agrees with the value printed on the name plate. ↳ Only allow competent persons to perform the electrical connection. ↳ Ensure that the functional earth (FE) is connected correctly. Fault-free operation is only guaranteed if the functional earth is connected properly. ↳ If faults cannot be rectified, take the sensor out of operation. Protect the sensor from accidentally being started.

NOTICE
Protective Extra Low Voltage (PELV) <ul style="list-style-type: none"> ↳ The sensor is designed in accordance with safety class III for supply with PELV (protective extra-low voltage).

 For all connections (connection cable, interconnection cable, etc.), use only the cables listed in the accessories (see chapter 14.2 "Accessories – cables and connectors").

6.2 Pin assignment

Pin assignment for ODS10L1.8/LAK-M12, ODS10L1.8/LAK,200-M12, ODS10L1-25M.8/LAK-M12

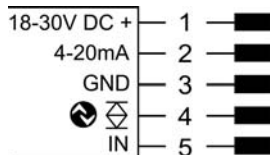



Figure 6.1: Pin assignment

Pin	Designation	Assignment
1	18-30 V DC +	Supply voltage
2	4-20 mA	Configurable analog output <ul style="list-style-type: none"> • Current: 4 mA ... 20 mA • Voltage: 1 V ... 10 V, 0 V ... 10 V Factory setting: Current
3	GND	Functional earth
4		IO-Link / switching output 1, push-pull
5	IN	Function of the switching input

Pin assignment ODS10L1.8/L6X-M12

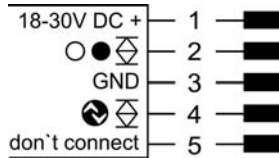

Figure 6.2: Pin assignment

Pin	Designation	Assignment
1	18-30 V DC +	Supply voltage
2	○●◊	Switching output 2, push-pull
3	GND	Functional earth
4	⊗◊	IO-Link / switching output 1, push-pull
5	don't connect	don't connect

Pin assignment ODS10L1.8/LAK, ODS10L1-25M.8/LAK

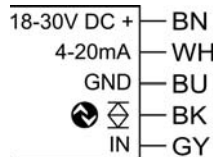

Figure 6.3: Pin assignment

Pin	Designation	Assignment	Core color
1	18-30 V DC +	Supply voltage	BN, brown
2	4-20 mA	Configurable analog output <ul style="list-style-type: none"> • Current: 4 mA ... 20 mA • Voltage: 1 V ... 10 V, 0 V ... 10 V Factory setting: Current	WH, white
3	GND	Functional earth	BU, blue
4	⊗◊	IO-Link / switching output 1, push-pull	BK, black
5	IN	Function of the switching input	GY, gray

Pin assignment ODS10L1.8/LA6-M12, ODS10L1.8/LA6,200-M12

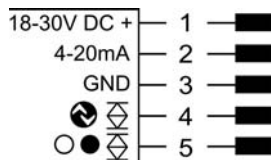



Figure 6.4: Pin assignment

Pin	Designation	Assignment
1	18-30 V DC +	Supply voltage
2	4-20 mA	Configurable analog output <ul style="list-style-type: none"> • Current: 4 mA ... 20 mA • Voltage: 1 V ... 10 V, 0 V ... 10 V Factory setting: Current

Pin	Designation	Assignment
3	GND	Functional earth
4		IO-Link / switching output 1, push-pull
5		Switching output 2, push-pull

7 Commissioning – sensors with analog interface

7.1 Setting the analog output

7.1.1 Configuring the analog output

The sensors are equipped with an analog output with linear response within the respective measurement range. Above and below the measurement range linearity is not obtained. If a signal is present, the output values can be used to determine whether the measurement range is exceeded or not met.

The analog output is configured using the OLED display and the keyboard (see chapter 3.4) or using the *Sensor Studio* configuration software (see chapter 9).

In order to achieve the highest resolution possible, set the range of the analog output as small as the application allows.

The characteristic output curve can be configured as rising or falling. For this purpose, both distance values *Position Min. Val.* and *Position Max. Val.* for the minimum and maximum analog output value are set accordingly.

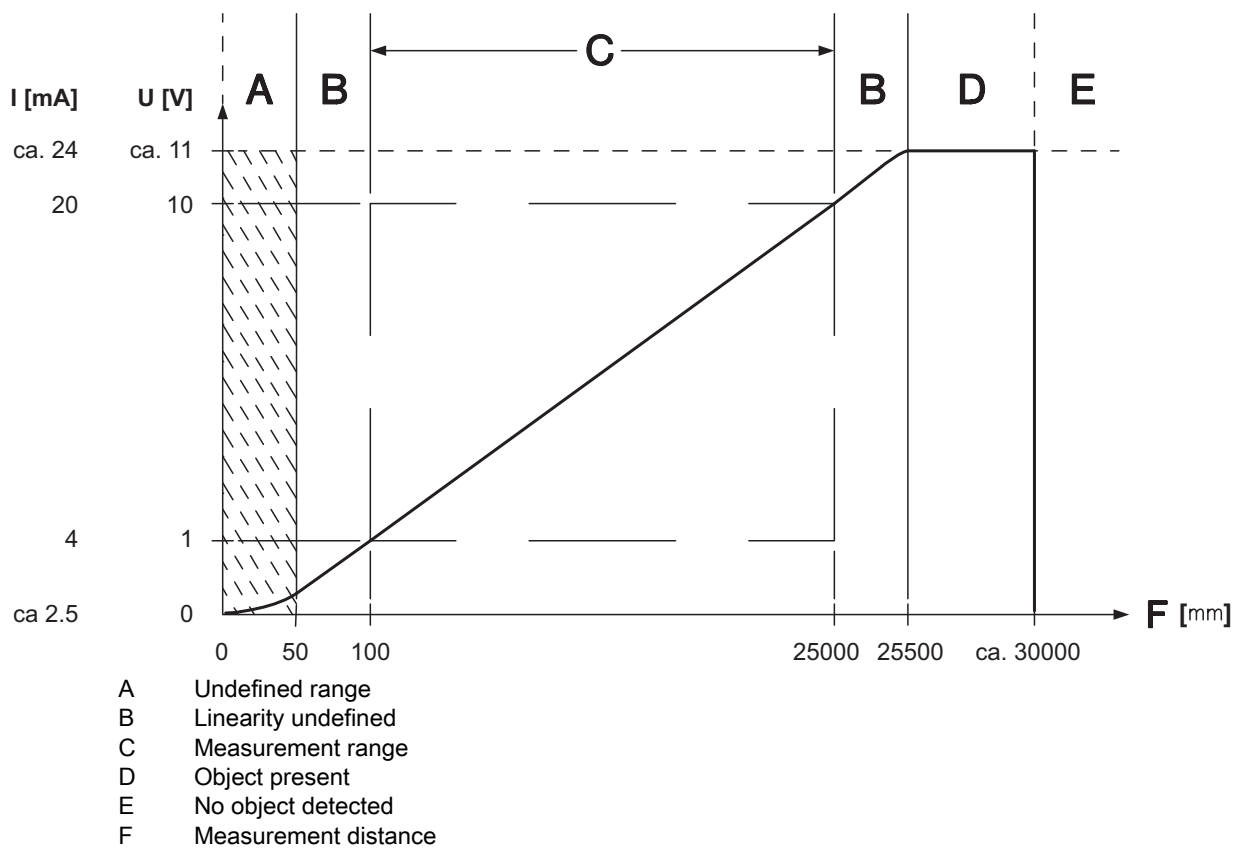

Figure 7.1: Behavior of analog output ODS10L1-25M.8/L (factory setting)

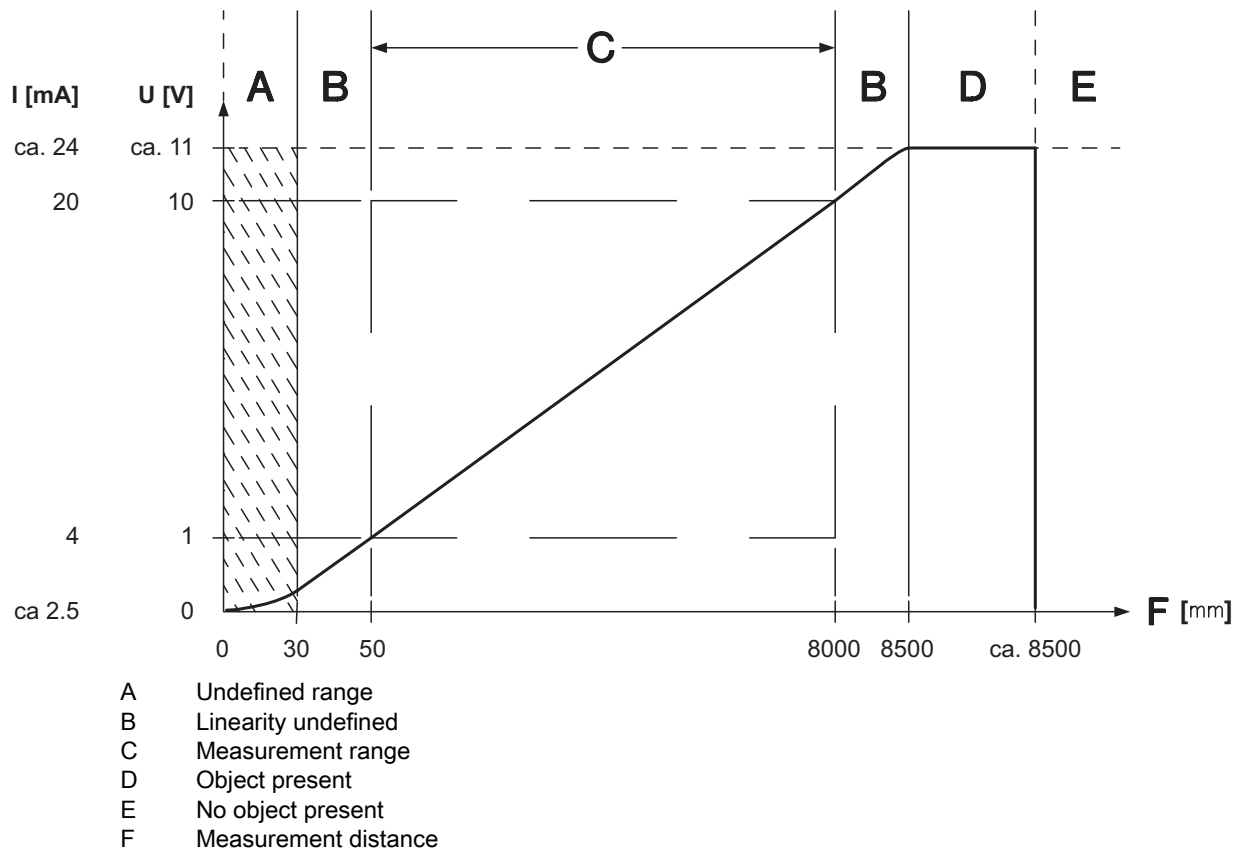

Figure 7.2: Behavior of analog output ODS10L1.8/L (factory setting)

7.1.2 Teaching the analog output

You can set the characteristic output curve for the analog output via the configuration menu. Alternatively, the analog output can be taught via pin 5.



Teaching is only possible for sensors with a switching input.

↪ Activate teaching in the configuration menu via the OLED display and keyboard:

Input > Input Mode > Teach



Move through the configuration menu with the navigation button ▼.

Activate the desired selection with the enter button ↵.

↪ Position the measurement object at the desired distance.

↪ Activate the teach input (pin 5) by applying the supply voltage.

The duration of activation of the teach input determines the teach-in function.

Table 7.1: Teach-in function depending on the duration of the teach signal

Teach-in function	Duration of the teach signal (T)
Distance value for the start of the measurement range Corresponds to 1 V or 4 mA on the analog output (pin 5)	120 ms ... 180 ms
Distance value for the end of the measurement range Corresponds to 10 V or 20 mA on the analog output (pin 5)	220 ms ... 280 ms

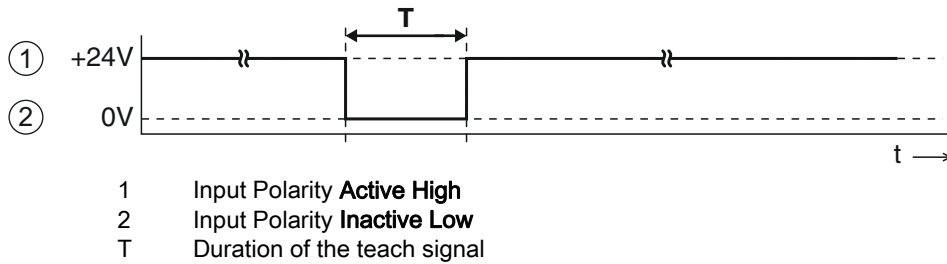



Figure 7.3: Plot of the teach signal

⚡ Ensure that the teach values are taken over correctly by checking the corresponding entries in the configuration menu.

7.2 Setting the switching outputs

 All sensors are provided with a switching output Q1. Sensor models with “66” in the part number code are also provided with a second switching output Q2.

7.2.1 Configuring switching outputs

For each switching output you can configure the following parameters:

- Upper and lower switching point
- Hysteresis
- Switching behavior
Light switching or dark switching

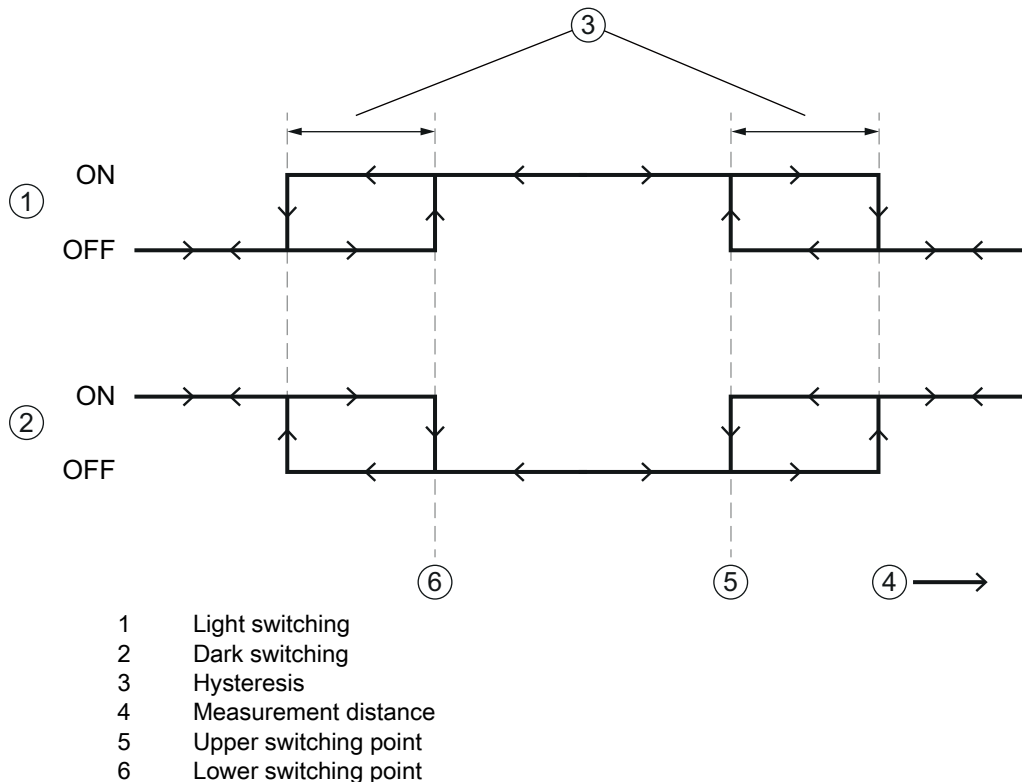

Figure 7.4: Switching output configuration

Configuration of the switching output(s) is performed using the OLED display and the keyboard (see chapter 3.4) or using the *Sensor Studio* configuration software (see chapter 9).

7.2.2 Teaching the switching outputs

You can set switching points, hysteresis and switching behavior for the switching outputs via the configuration menu.

Alternatively, the switching output can be taught via pin 5.



Teaching is only possible for sensors with a switching input.

↵ Activate teaching in the configuration menu via the OLED display and keyboard:

Input > Input Mode > Teach



Move through the configuration menu with the navigation button ▼.

Activate the desired selection with the enter button ↵.

↵ Statically position the measurement object at the desired distance.

↵ Activate the teach input (pin 5) by applying the supply voltage.

The duration of activation of the teach input determines the teach-in function.

Table 7.2: Teach-in function depending on the duration of the teach signal

Teach function	Duration of the teach signal (T)
Auto-teach Q1	20 ms ... 80 ms
Window teach Q1	320 ms ... 380 ms

The following possibilities exist for teaching the switching range:

The examples describe teaching switching output Q1 for a sensor with a measurement range of 50 mm ... 4000 mm.

- Teach the upper switching point
 If the lower switching point is set to the lower limit of the measurement range using the menu or configuration software, the upper switching point is taught.
 Switching point *Q1 Lower Sw. Pt.* = 50 mm and switching point *Q1 Upper Sw. Pt.* < 4000 mm, e.g.:
 - Switching point *Q1 Lower Sw. Pt.* = 50 mm
 - Switching point *Q1 Upper Sw. Pt.* = 1200 mm
 The teach point defines the upper switching point. If a measurement distance of e.g. 1000 mm is now taught, Q1 switches on at 50 mm and back off at 1000 mm.
- Teach the lower switching point
 If the upper switching point is set to the upper limit of the measurement range using the menu or configuration software, the lower switching point is taught.
 Switching point *Q1 Upper Sw. Pt.* = 4000 mm and switching point *Q1 Lower Sw. Pt.* > 50 mm, e.g.:
 - Switching point *Q1 Upper Sw. Pt.* = 4000 mm
 - Switching point *Q1 Lower Sw. Pt.* = 800 mm
 The teach point defines the lower switching point. If a measurement distance of e.g. 1000 mm is now taught, Q1 switches on at 800 mm and back off at 4000 mm.
- Teach window
 If both switching points are set to values ≠ the lower or upper limit of the measurement range, the difference between the two values defines a switching range.
 Switching point *Q1 Lower Sw. Pt.* > 50 mm and switching point *Q1 Upper Sw. Pt.* < 4000 mm, e.g.:
 - Switching point *Q1 Lower Sw. Pt.* = 1100 mm
 - Switching point *Q1 Upper Sw. Pt.* = 1200 mm
 - Switching range: 100 mm
 The teach point lies in the middle of the switching range. If a measurement distance of e.g. 1000 mm is now taught, the switching output Q1 switches on at 950 mm and back off at 1050 mm.

7.3 Setting measure mode

↪ Set the measure mode using the OLED display and the keyboard (**Application** menu item; see chapter 3.4.5 "Application menu") or using the *Sensor Studio* configuration software (see chapter 9).

- Standard
Standard setting
- Precision (factory setting)
Twice as accurate as the standard setting
- Speed
One third as accurate as the standard setting, approx. six times faster

In the table, you will find an overview of how the choice of measure mode affects the individual parameters of the measurement function.

Table 7.3: Measure mode and measurement function parameter

Measure mode	Accuracy	Measurement time	Measurement value update
Standard	+	20 ms	+
Precision	+ +	50 ms	- -
Speed	-	3.5 ms	+ +

7.4 Reset to factory settings

Configuration is performed using the OLED display and the keyboard (see chapter 3.4) or using the *Sensor Studio* configuration software (see chapter 9).

8 Commissioning – sensors with IO-Link interface

8.1 Overview

The sensors are equipped with an IO-Link 1.1 interface for measurement data output.

- The sensor transfers data packets in the TYPE_2_V process data format.
- Eight status bits and 16 measurement value bits are transferred. On the control-side, you can only use the measurement value bits.
- The sensor cyclically transfers (minCycleTime = 3.5 ms) data packets at a baud rate of 38.4 kBaud (COM2).
- The process data and parameters are described in the IO Device Description (IODD) file. You can download the IODD file on the Internet from www.leuze.com.
- You can configure the sensor using the *Sensor Studio* configuration software; see chapter 9 "Connecting to a PC – Sensor Studio".

8.2 IO-Link process data

Process data format: M-sequence TYPE_2_V

- PDOOut (Master -> Sensor): none
- PDIn (Sensor -> Master): 24-bit (16 measurement value bits, 8 status bits)

Measurement values

16-bit measurement value: distance to the object – between lower and upper limit of the measurement range – in mm.

15	14	13	12	11	10	9	8	7	6	5	4	3	2	1	0
----	----	----	----	----	----	---	---	---	---	---	---	---	---	---	---

Special values:

- Signal=0 (no reception signal): 65535
- Measurement range exceeded: upper limit of the measurement range
- Measurement range below minimum value: lower limit of the measurement range
- Measurement=0 (while teaching or during activation): last measurement value
- Measurement=0 (during start-up): 65535

Status bits

Table 8.1: Status bits

Bit	23	22	21	20	19	18	17	16
Value	0	0	W	S	M	Q3	Q2	Q1
0	Unassigned bits (bit 22 and bit 23) are 0; initialization state is also 0							
M	1: running measurement (measurement running) 0: during start-up, teaching, deactivation							
S	1: signal OK, reception signal is sufficient for measurement value output							
W	1: warning; e.g., weak reception signal							
Q1 ... Q3	Switching states Q1, Q2, Q3 1: active							

9 Connecting to a PC – *Sensor Studio*

The *Sensor Studio* configuration software – in combination with an IO-Link USB master – provides a graphical user interface for the operation, configuration and diagnosis of sensors with IO-Link configuration interface (IO-Link devices), independent of the selected process interface.

Each IO-Link device is described by a corresponding IO Device Description (IODD file). After importing the IODD file into the configuration software, the IO-Link device connected to the IO-Link USB master can be operated, configured and checked – conveniently and in multiple languages. An IO-Link device that is not connected to the PC can be configured offline.

Configurations can be saved and reopened as projects for transferring back to the IO-Link device at a later time.



Only use the *Sensor Studio* configuration software for products manufactured by **Leuze electronic**.

The *Sensor Studio* configuration software is offered in the following languages: German, English, French, Italian and Spanish.

The FDT frame application of the *Sensor Studio* supports all languages; all languages may not be supported in the IO-Link device DTM (Device Type Manager).

The *Sensor Studio* configuration software is designed according to the FDT/DTM concept:

- You make the individual configuration settings for the sensor in the Device Type Manager (DTM).
- The individual DTM configurations of a project can be called up via the frame application of the Field Device Tool (FDT).
- Communication DTM: IO-Link USB master
- Device DTM: I/O-Link Device/IODD for ODS 10

NOTICE

Configuration changes only via the control!

↻ **Always** perform the configuration for process mode via the control and, if applicable, the interface.

In process mode, only the configuration conveyed via the control is active. The configuration changes made via *Sensor Studio* are only active in process mode if they were previously transmitted 1:1 to the control.

Procedure for the installation of the software and hardware:

- ↻ Install the *Sensor Studio* configuration software on the PC.
- ↻ Install the driver for the IO-Link USB master on the PC.
- ↻ Connect the IO-Link USB master to the PC.
- ↻ Connect the OSD 10 (IO-Link device) to the IO-Link USB master.
- ↻ Install IO-Link device DTM with IODD file for ODS 10 in the *Sensor Studio* FDT frame.

9.1 System requirements

To use the *Sensor Studio* configuration software, you need a PC or laptop with the following specifications:

Table 9.1: System requirements for *Sensor Studio* installation

Operating system	Windows 7 Windows 8
Computer	<ul style="list-style-type: none"> • Processor type: 1 GHz or higher • USB interface • CD-ROM drive • Main memory <ul style="list-style-type: none"> • 1 GB RAM (32-bit operating system) • 2 GB RAM (64-bit operating system) • Keyboard and mouse or touchpad
Graphics card	DirectX 9 graphic device with WDDM 1.0 or higher driver
Additionally required capacity for <i>Sensor Studio</i> and IO-Link device DTM	350 MB hard drive memory 64 MB main memory



Administrator privileges on the PC are necessary for installing *Sensor Studio*.

9.2 Installing *Sensor Studio* configuration software and IO-Link USB master



The installation files of the *Sensor Studio* configuration software must be downloaded from the Internet at www.leuze.com.

For subsequent updates, you can find the most recent version of the *Sensor Studio* installation software on the Internet at www.leuze.com.

9.2.1 Downloading configuration software

- ↪ Call up the Leuze home page: www.leuze.com
- ↪ Enter the type designation or part number of the device as the search term.
- ↪ The configuration software can be found on the product page for the device under the *Downloads* tab.



On delivery, the device is configured for HID operation (Human Interface Device). The device can thereby be operated directly via the Windows application.

If you would like to make other settings via the USB interface, you must download the USB driver from the Leuze home page (file name *SW_CR5x_Virtual_COM_Port_Drivers...*).

9.2.2 Installing the *Sensor Studio* FDT frame

NOTICE
<p>First install the software!</p> <ul style="list-style-type: none"> ↪ Do not yet connect the IO-Link USB master to the PC. <p>First install the software.</p>



If FDT frame software is already installed on your PC, you do not need the *Sensor Studio* installation.

You can install the communication DTM (IO-Link USB master) and the device DTM (IO-Link device ODS 10) in the existing FDT frame.

- ↪ Start your PC with administrator privileges and log on.
 - ↪ Download the *Sensor Studio* configuration software from the Internet:
www.leuze.com > Products > Measuring Sensors > Distance Sensors > Optical Distance Sensors > ODS 10 > Downloads tab > Software/Drivers
 - ↪ Copy the file into a suitable folder on your hard drive and unpack the zip file.
 - ↪ Start the *SensorStudioSetup.exe* file and follow the instructions on the screen.
- The Installation Wizard installs the software and places a shortcut on the desktop ().

9.2.3 Installing drivers for IO-Link USB master

- ↪ Select the **IO-Link USB Master** installation option and follow the instruction on the screen.
- The Installation Wizard installs the software and places a shortcut on the desktop ().

9.2.4 Connecting IO-Link USB master to the PC

The sensor is connected to the PC via the IO-Link USB master (see table 14.3.1).

- ↪ Connect the IO-Link USB master to the plug-in power supply unit or the mains supply.



Included in the delivery contents of the IO-Link USB master is a USB interconnection cable for connecting the PC to the IO-Link USB master as well as a plug-in power supply unit and a short description.

The mains supply of the IO-Link USB master via the plug-in power supply unit is only activated if IO-Link USB master and PC are connected via the USB interconnection cable.

- ↪ Connect the PC to the IO-Link USB master.

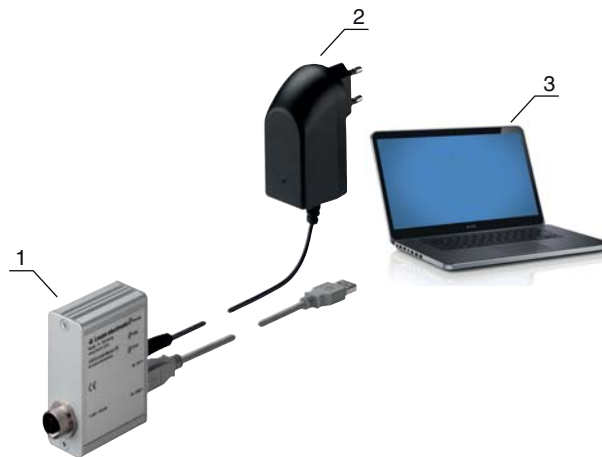

- 1 IO-Link USB master
- 2 Plug-in power supply unit
- 3 PC

Figure 9.1: PC connection via the IO-Link USB master

- ↪ The **wizard for searching for new hardware** starts and installs the driver for the IO-Link USB master on the PC.

9.2.5 Connecting IO-Link USB master to the sensor

Prerequisites:

- IO-Link USB master and PC are connected via the USB interconnection cable.
- IO-Link USB master is connected to the mains supply with the plug-in power supply unit.

NOTICE**Connect the plug-in power supply unit for IO-Link USB master!**

↪ To connect the sensor, the plug-in power supply unit must be connected to the IO-Link USB master and the mains supply.

The voltage supply via the USB interface of the PC is permissible only for IO-devices with a current consumption of up to 40 mA at 24 V.



Included in the delivery contents of the IO-Link USB master is a USB interconnection cable for connecting the PC to the IO-Link USB master as well as a plug-in power supply unit and a short description.

The voltage supply of the IO-Link USB master and the sensor via the plug-in power supply unit is only activated if IO-Link USB master and PC are connected via the USB interconnection cable.

↪ Connect the IO-Link USB master to the M12 connection of the sensor via an interconnection cable.

The interconnection cable is not included in the delivery contents and must be ordered separately if needed (see chapter 14.3.1).

9.2.6 Installing the DTM and IODD

Prerequisites:

- The sensor is connected to the PC via the IO-Link USB master.
- FDT frame and driver for IO-Link USB master are installed on the PC.

↪ Select the **IO-Link device DTM (User Interface)** installation option and follow the instructions on the screen.

The Installation Wizard installs the DTM and the IO Device Description (IODD) for the sensor.



DTM and IODD for all IO-Link devices currently available from Leuze electronic are installed.

9.3 Starting the *Sensor Studio*

configuration software

Prerequisites:

- The sensor has been mounted (see chapter 5) and connected (see chapter 6) correctly.
- The *Sensor Studio* configuration software is installed on the PC (see chapter 9.2 "Installing Sensor Studio configuration software and IO-Link USB master").
- The sensor is connected to the PC via the IO-Link USB master (see chapter 9.2 "Installing Sensor Studio configuration software and IO-Link USB master").

↪ Start the *Sensor Studio* configuration software by double-clicking the *Sensor Studio* icon ().

The **mode selection** of the **Project Wizard** is displayed

↪ Select the **Device selection without communication connection (offline)** configuration mode and click on [Next].

The **Project Wizard** displays the **device selection** list of the configurable devices.

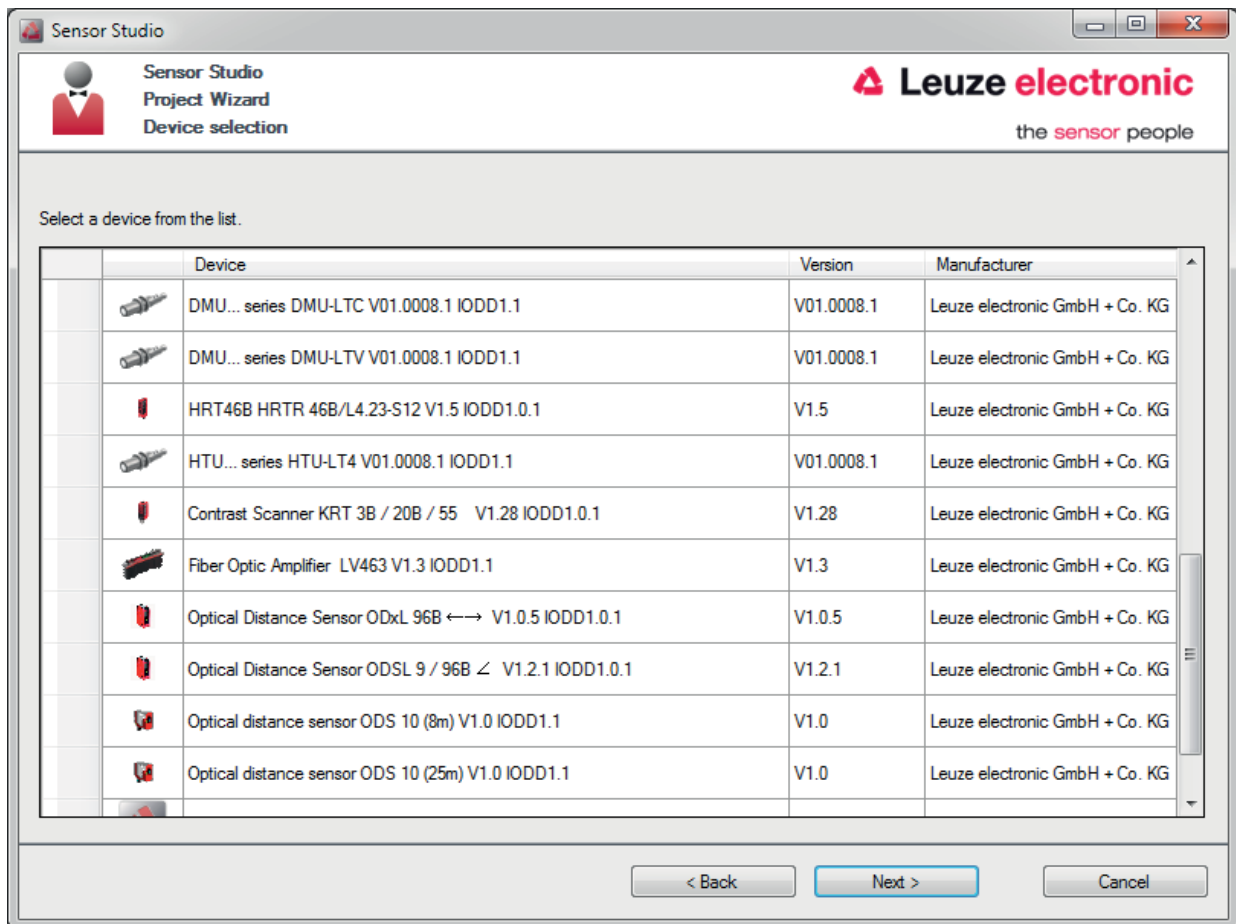



Figure 9.2: Device selection

☞ Select the connected sensor according to the configuration in the **device selection** and click on [Next]. The device manager (DTM) of the connected sensor starts with the offline view for the *Sensor Studio* configuration project.

☞ Establish the online connection to the connected sensor.

In the *Sensor Studio* FDT frame, click on the [Establish connection with device] button ().

In the *Sensor Studio* FDT frame, click on the [Online parameters] button ().

The IO-Link USB master synchronizes with the connected sensor and the current configuration data and measurement data are displayed in the device manager (DTM).

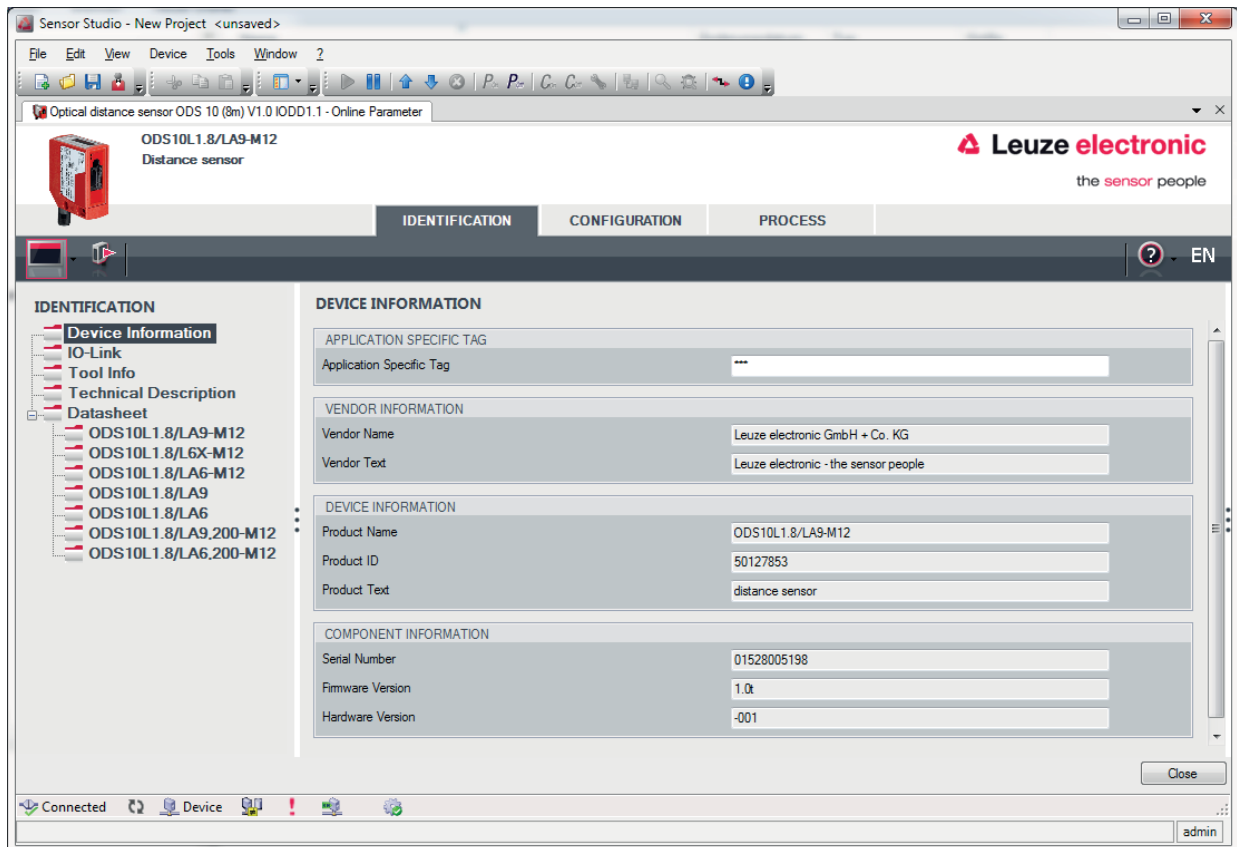

Figure 9.3: Configuration project: *Sensor Studio* device manager (DTM) for ODS 10

The menus of the *Sensor Studio* device manager (DTM) can be used to change or read out the configuration or process data of the connected sensor.

The user interface of the *Sensor Studio* device manager (DTM) is largely self-explanatory.

The online help system provides information on the menu items and adjustment parameters. Select the **Help** menu item in the menu [?].

9.4 Short description of the *Sensor Studio* configuration software

This chapter contains information and explanations on the individual menu items and adjustment parameters of the *Sensor Studio* configuration software and the device manager (DTM) for the ODS 10 distance sensor.



This chapter does not include a complete description of the *Sensor Studio* configuration software.

Complete information on the FDT frame menu and on the functions in the device manager (DTM) can be found in the online help system.

The device manager (DTM) of the *Sensor Studio* configuration software has the following main menus and functions:

- *IDENTIFICATION* (see chapter 9.4.2)
- *CONFIGURATION* (see chapter 9.4.3)
- *PROCESS* (see chapter 9.4.4)
- *DIAGNOSIS* (see chapter 9.4.5)



The online help system displays information on the menu items and adjustment parameters for each function. Select the **Help** menu item in the menu [?]

9.4.1 FDT frame menu



You can find complete information on the FDT frame menu in the online help system. Select the **Help** menu item in the menu [?].

9.4.2 IDENTIFICATION function

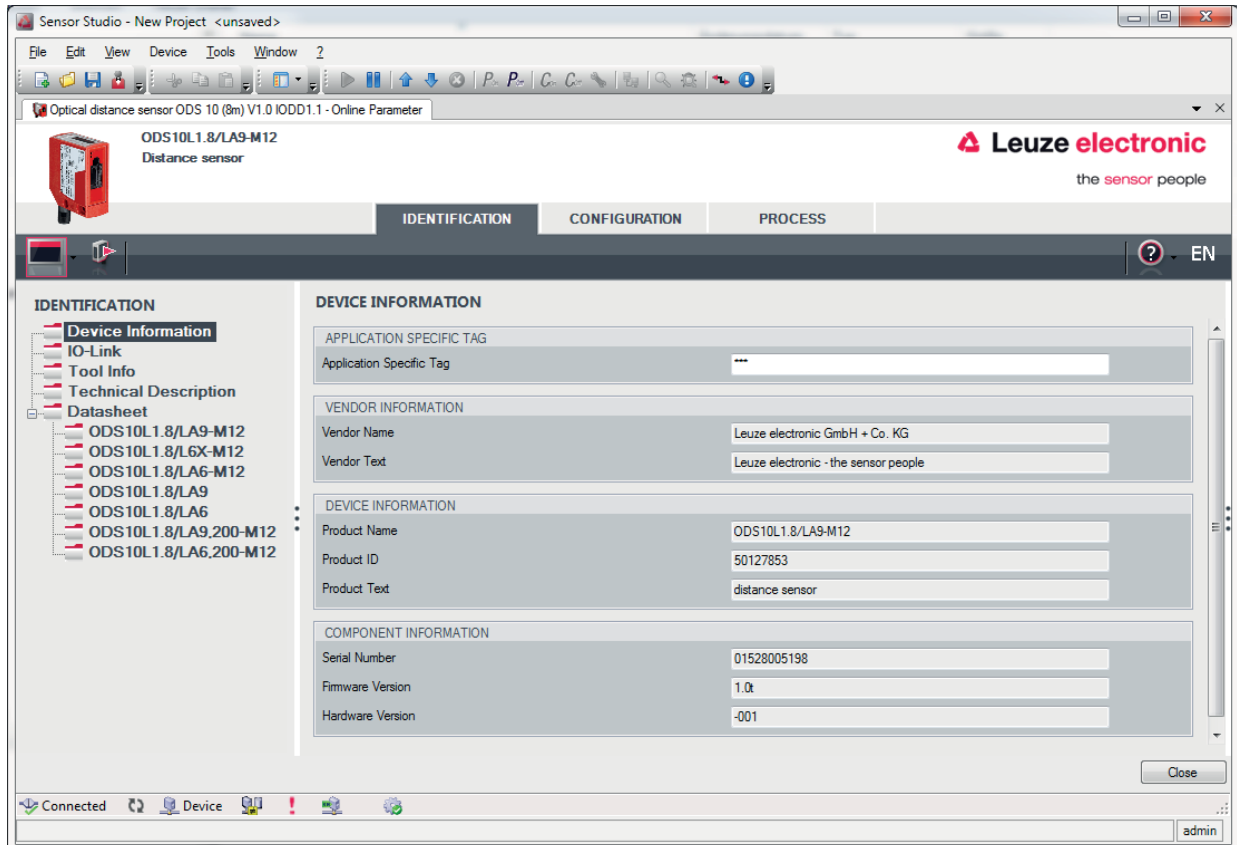

Figure 9.4: IDENTIFICATION function

- Device information, e.g., designation, order no., serial number, etc.
- Information on the IO-Link parameters of the connected sensor, e.g., Device ID, cycle time, etc.
- Technical description of the connected sensor
- Data sheet of the connected sensor

9.4.3 CONFIGURATION function

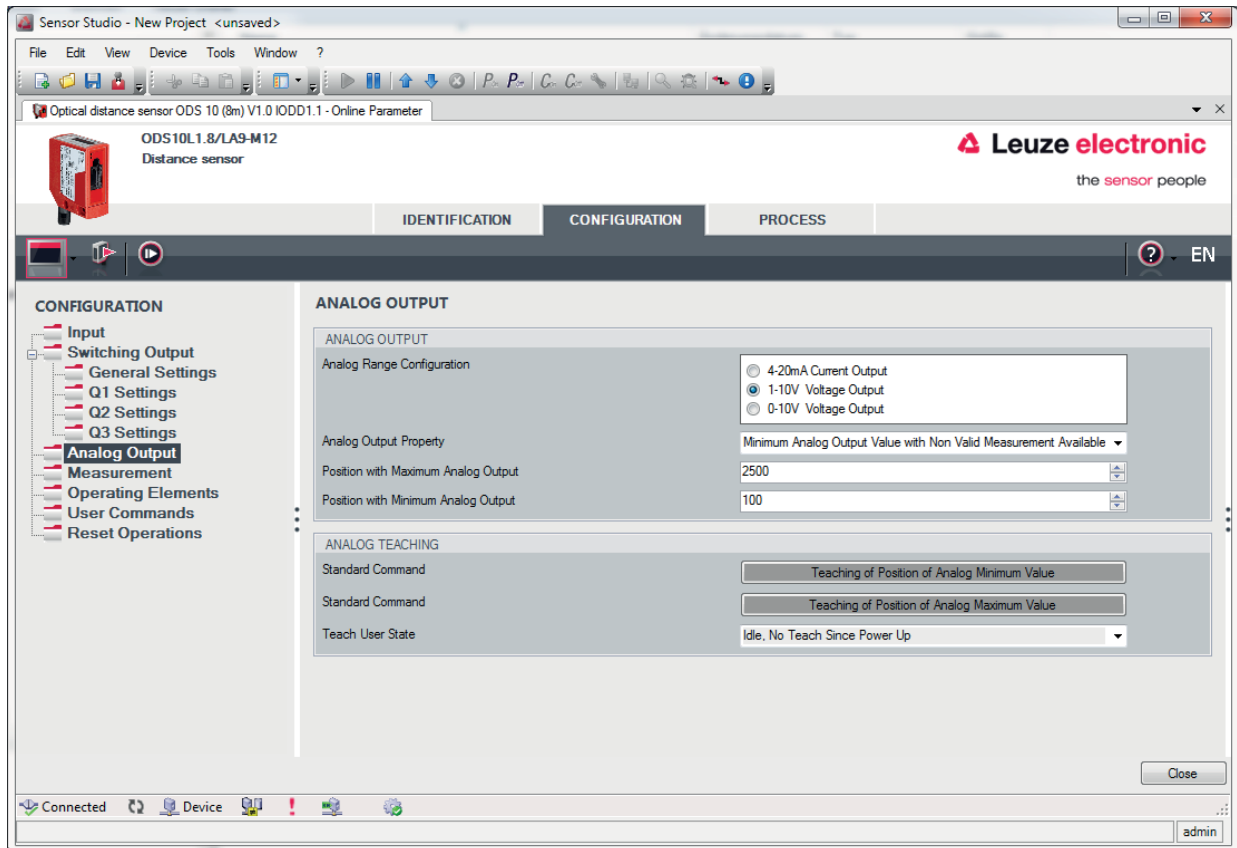

Figure 9.5: CONFIGURATION function

- Set the measure mode:
 - Precision
 - Standard
 - Speed
- Set the analog output functions
- Configuration of the digital switching inputs/outputs

9.4.4 PROCESS function

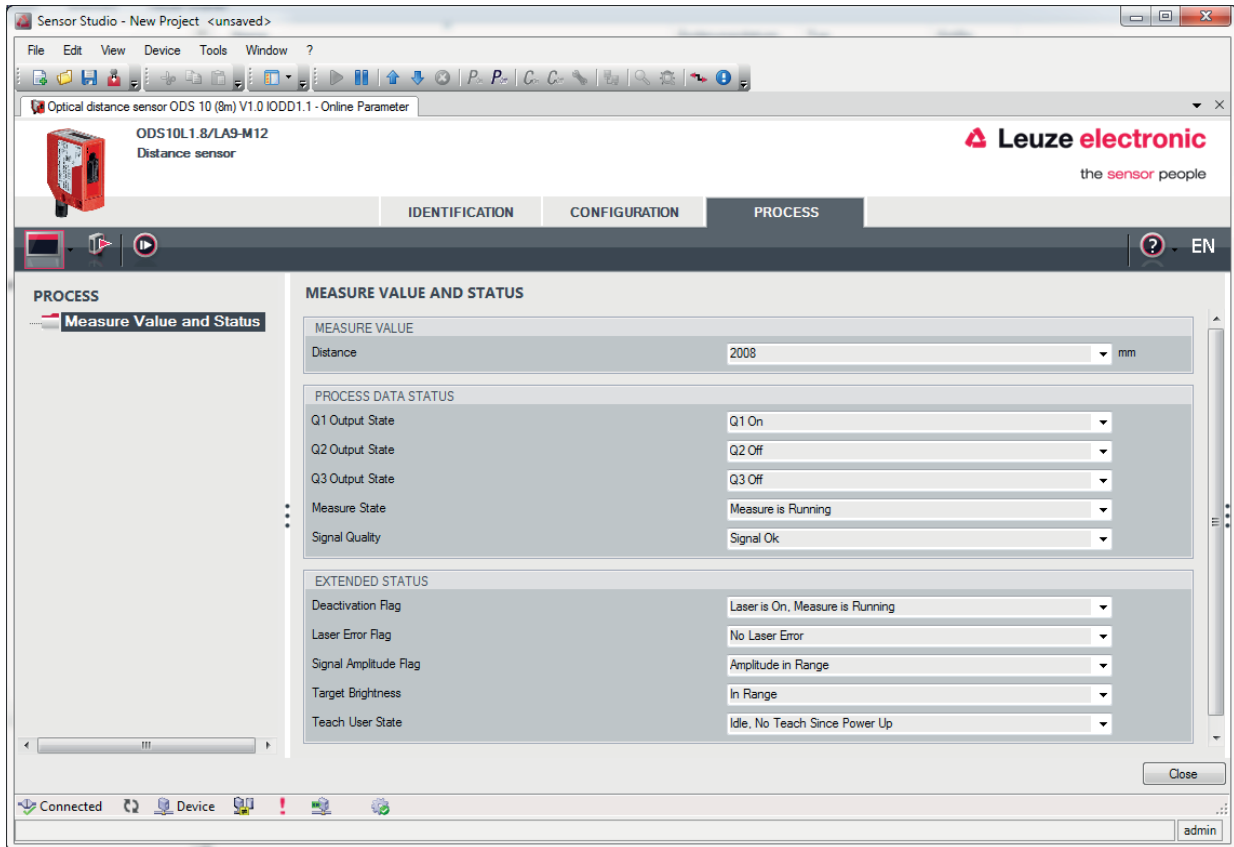

Figure 9.6: PROCESS function

- Visualization of the distance value and the states of the digital output signals. Text-based display of the current values:

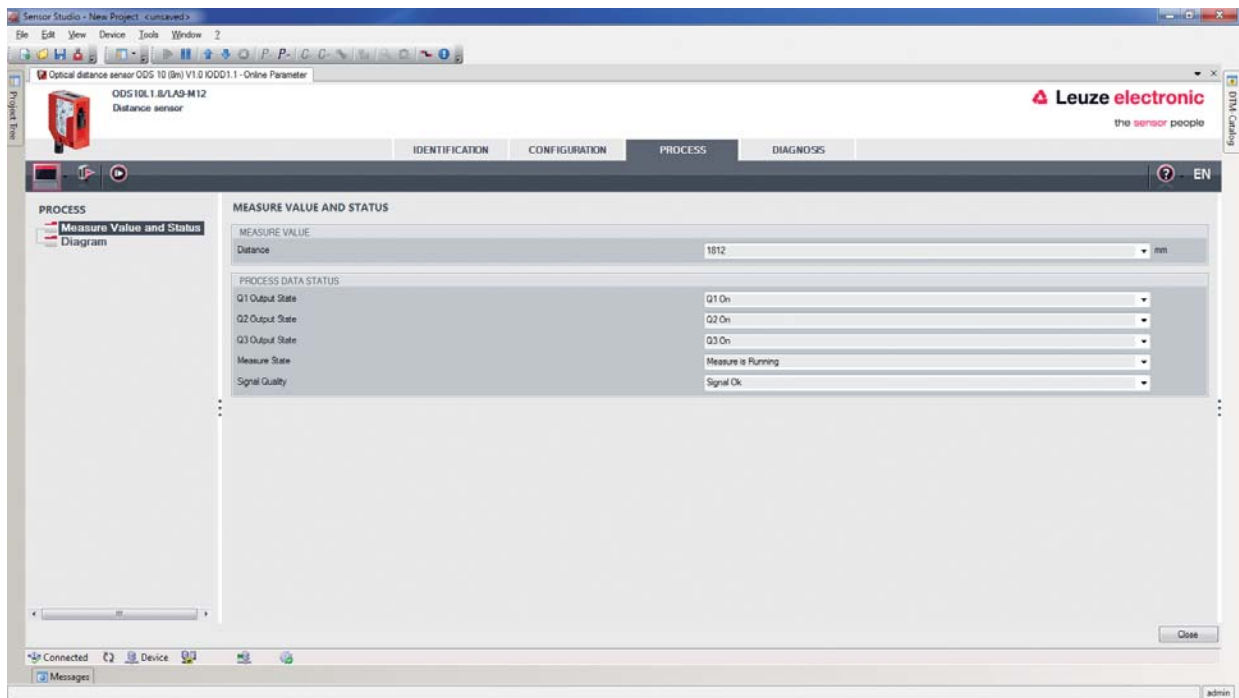

Figure 9.7: PROCESS function – distance value and status

- Graphical display of the recorded measurement values, including the history:

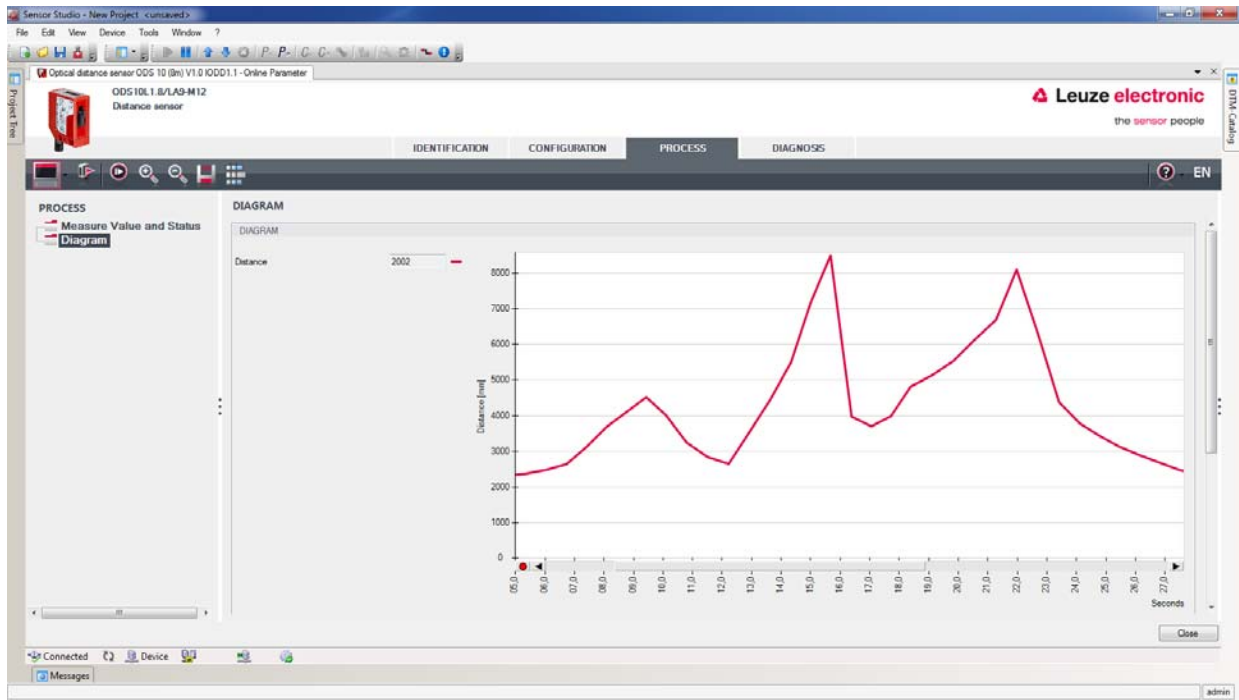

Figure 9.8: PROCESS function – display of the measurement values



Figure 9.9: PROCESS function – display of the measurement values

9.4.5 DIAGNOSIS function

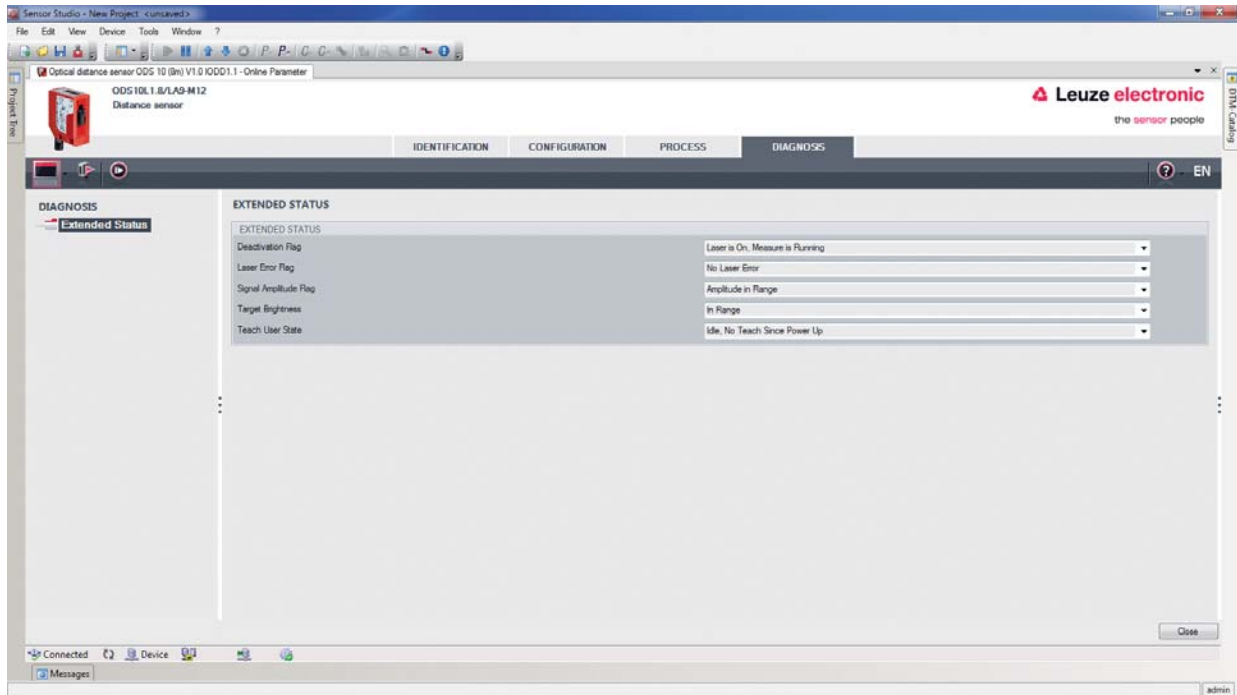

Figure 9.10: *DIAGNOSIS* function

- Information on the current device status
- Reset the device to factory settings

9.4.6 Exiting *Sensor Studio*

After completing the configuration settings, close the *Sensor Studio* configuration software

↳ Exit the program via **File > Exit**.

↳ Save the configuration settings as a configuration project on the PC.

You can open the configuration project again at later time via **File > Open** or via the *Sensor Studio Project Wizard* ().

10 Troubleshooting

10.1 What to do in case of failure?

After switching on the sensor, display elements (see chapter 3.3) assist in checking the proper function and troubleshooting.

In case of error, you can determine the error from the LEDs and the indicators on the display. With the error message you can determine the cause of the error and initiate measures to rectify it.

↪ Switch off the system and leave it switched off.

↪ Analyze the cause of the error using the operation indicators, the error messages and with the help of the *Sensor Studio* configuration software, **DIAGNOSTICS** menu, and rectify the error.

NOTICE
Contact Leuze electronic subsidiary/customer service.
↪ If you are unable to rectify a fault, contact the Leuze electronic branch responsible for you or call the Leuze electronic customer service (see chapter 12 "Service and support").

10.2 LED indicators

You can use the LED indicators to ascertain general causes of errors; see chapter 3.3.1 "LED indicators".

Table 10.1: Green/red LED – causes and measures

Error display	Possible cause	Measures
Orange	Warning message, e.g., weak reception signal	Optimize object alignment
Red	No object detected or reception signal too weak	Position object in the measurement range
Off	<ul style="list-style-type: none"> No supply voltage connected to the sensor Hardware error 	<ul style="list-style-type: none"> Check supply voltage Contact Leuze electronic customer service(see chapter 12 "Service and support")

Table 10.2: Yellow LED – causes and measures

Error display	Possible cause	Measures
Off	No object detected in the switching range	Position object in the configured switching range

10.3 Indicators in the display

You can use the status indicators in the display to ascertain general error causes; see chapter 3.3.3 "Display".

Table 10.3: Display indicators – causes and measures

Display	Possible cause	Measures
	Warning message, e.g., weak reception signal	Optimize object alignment
No Signal	No object detected or reception signal too weak	Position object in the measurement range

Display	Possible cause	Measures
Signal Error Wrench icon	Signal failure Sensor defective	If the icon is displayed continuously: contact Leuze electronic customer service (see chapter 12 "Service and support")
Down arrow	The current measurement value is less than the lower limit of the analog output	Change the setting for the lower limit of the measurement range (see chapter 3.4.4 "Analog Output menu")
Up arrow	The current measurement value is greater than the upper limit of the analog output	Change the setting for the upper limit of the measurement range (see chapter 3.4.4 "Analog Output menu")

11 Care, maintenance and disposal

11.1 Cleaning

If there is dust on the device:

- ↳ Clean the device with a soft cloth; use a cleaning agent (commercially available glass cleaner) if necessary.

NOTICE
<p>Do not use aggressive cleaning agents!</p> <ul style="list-style-type: none"> ↳ Do not use aggressive cleaning agents such as thinner or acetone for cleaning the device. Use of improper cleaning agents can damage the lens cover.

11.2 Servicing

The device does not normally require any maintenance by the operator.

Repairs to the device must only be carried out by the manufacturer.

- ↳ For repairs, contact your responsible Leuze electronic subsidiary or Leuze electronic customer service (see chapter 12 "Service and support").

11.3 Disposing

- ↳ For disposal observe the applicable national regulations regarding electronic components.

12 Service and support

Number to call for 24-hour on-call service:

+49 (0) 7021 573 - 0

Service hotline:

+49 (0) 7021 573 - 123

Monday to Friday 8.00 a.m. to 5.00 p.m. (UTC+1)

E-mail:

service.identify@leuze.de

Repair service and returns:

Procedure and Internet form can be found at

www.leuze.com/repair

Return address for repairs:

Service Center

Leuze electronic GmbH + Co. KG

In der Braike 1

D-73277 Owen / Germany

12.1 What should I do if service is required?

NOTICE
Please use this chapter as a master copy if service is required!
↪ Enter the contact information and fax the form together with your service order to the fax number given below.

Customer data (please complete)

Device type:	
Serial number:	
Firmware:	
Display messages:	
Status of LEDs:	
Error description:	
Company:	
Contact person/department:	
Phone (direct dial):	
Fax:	
Street/No:	
ZIP code/City:	
Country:	

Leuze Service fax number:

+49 7021 573 - 199

13 Technical data

13.1 General specifications

Table 13.1: Optics

Measurement range	100 mm ... 25000 mm (measurement against reflective tape) 50 mm ... 8000 mm (90% diffuse reflection; measurement against diffusely reflective objects) 50 mm ... 3500 mm (6% ... 90% diffuse reflection; measurement against diffusely reflective objects)
Resolution	3 mm
Light source	Laser diode Laser class 1 acc. to IEC 60825-1:2007
Wavelength	658 nm (red, visible)
Pulse duration	6 ns
Max. output power (peak)	391 mW
Light spot	Approx. 7 mm x 7 mm at a distance of 4 m

Table 13.2: Error limits

Accuracy	±30 mm <ul style="list-style-type: none"> • Measurement range 50 mm ... 3500 mm • Luminosity coefficient 6% ... 90% • "Precision" operating mode • At 20 °C after warmup time of 20 minutes • Average range of the supply voltage U_B • Measurement object $\geq 50 \times 50 \text{ mm}^2$
Reproducibility	4 mm <ul style="list-style-type: none"> • Same measurement object • Identical environmental conditions • "Precision" operating mode • After warmup time of 20 minutes • Measurement object $\geq 50 \times 50 \text{ mm}^2$
B/w detection thresholds Luminosity coefficient 6% ... 90%	±10 mm
Temperature drift	±2 mm/K

Table 13.3: Timing

Measurement time	Operating mode <ul style="list-style-type: none"> • "Fast": 3.5 ms • "Standard": 20 ms • "Precision": 50 ms Factory setting
Delay before start-up	≤ 300 ms

Table 13.4: Electrical equipment

Operating voltage U_B Supply voltage	18 V ... 30 V DC incl. residual ripple
Residual ripple	$\leq 15\%$ of U_B
Open-circuit current	≤ 150 mA
Switching output	Push-pull switching output Notice! The push-pull switching outputs must not be connected in parallel.
Signal voltage high/low	$\geq (U_B - 2 \text{ V}) / \leq 2 \text{ V}$
Analog output ODS10L1.8/LA...	<ul style="list-style-type: none"> • Voltage 1 V ... 10 V / 0 V ... 10 V $R_L \geq 2 \text{ k}\Omega$ • Current (factory setting) 4 V ... 20 mA, $R_L \leq 500 \Omega$
IO-Link	COM2 (38.4 baud), Vers. 1.1 min. cycle time: 2.3 ms SIO is supported

Table 13.5: Operating and display elements

Display	OLED display
Keyboard	Two buttons
LEDs	Status LED on the control panel, two-colored (red/green) LED for object detection on the lens cover (yellow)

Table 13.6: Mechanical data

Housing	Plastic
Optics cover	Glass
Weight	Connection type <ul style="list-style-type: none"> • M12 connector: 70 g • Connection cable, 2000 mm: 133 g • Connection cable, 200 mm, with M12 connector: 90 g
Connection type	M12 connector, turnable 90° Connection cable, 2000 mm, wire cross section 5 x 0.14 mm ² (5 x 26 AWG) Connection cable, 200 mm, with M12 connector

Table 13.7: Environmental data

Ambient temperature (operation)	-40 °C ... +50 °C
Ambient temperature (storage)	-40 °C ... +70 °C
Protective circuit	Transient protection Polarity reversal protection Short circuit protection for all outputs

VDE safety class	III
Degree of protection	IP 67
Standards applied	IEC 60947-5-2

13.2 Dimensioned drawings

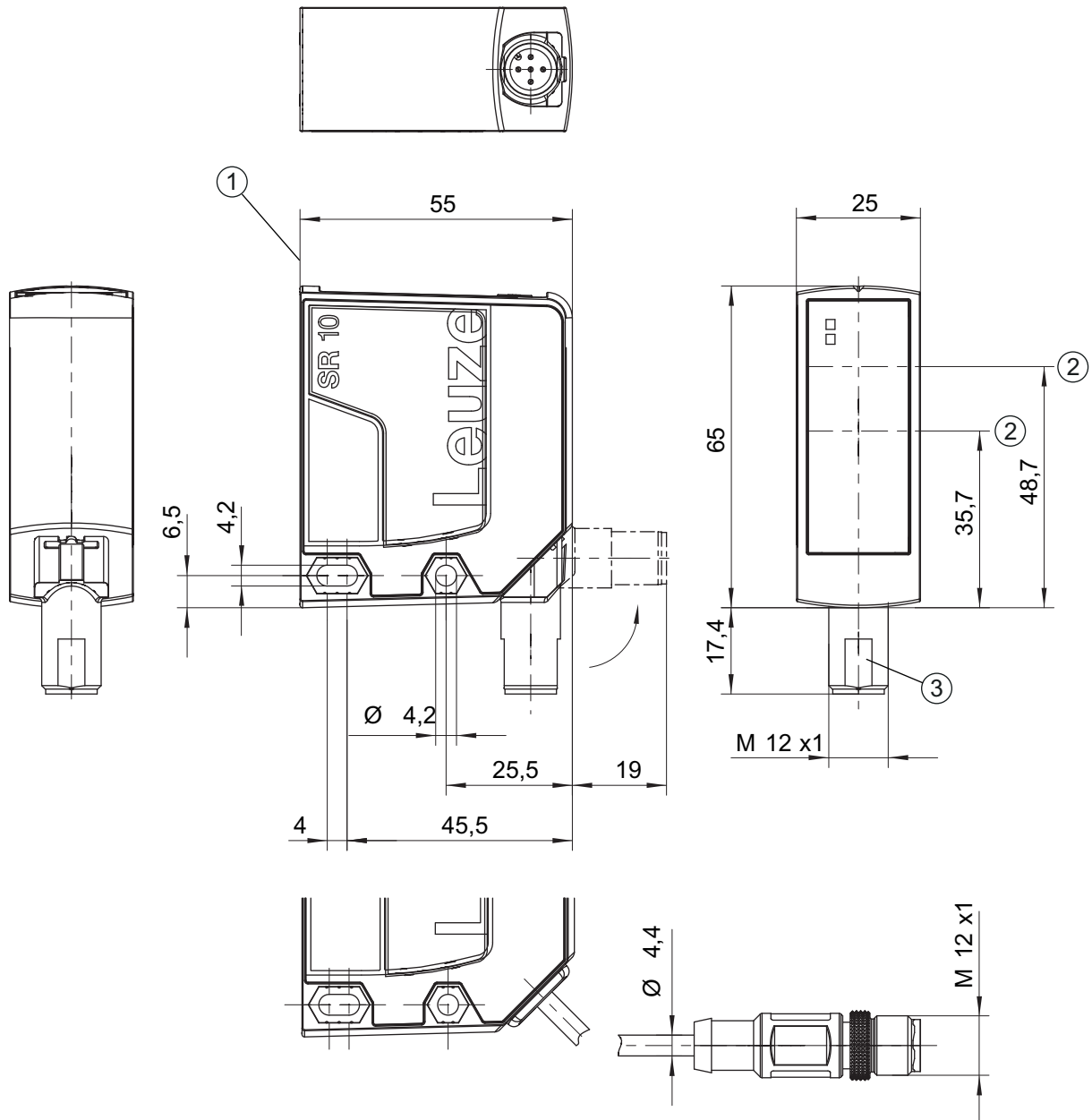

- all dimensions in mm
- 1 Reference edge for the measurement
- 2 Optical axis
- 3 M12 connector, turnable 90°

Figure 13.1: Dimensioned drawing ODS 10 with M12 connector

13.3 Dimensioned drawings: Accessories

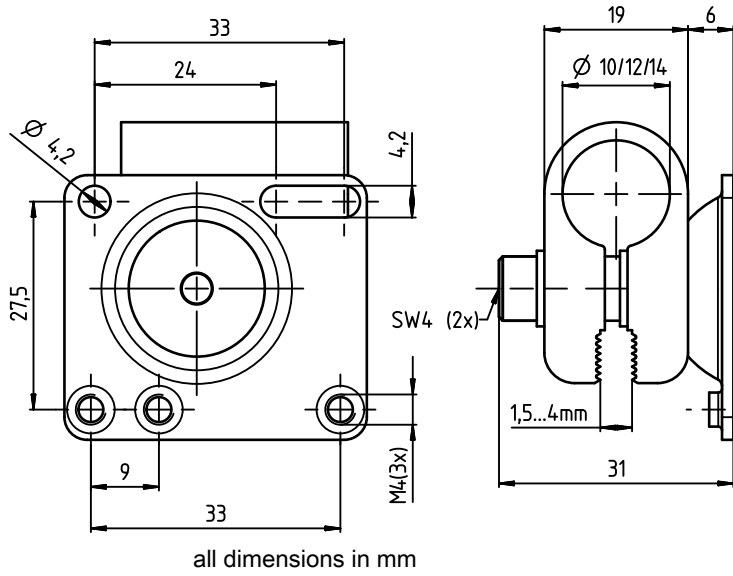

Figure 13.2: Dimensioned drawing mounting system BTU 300M-D10/D12/D14

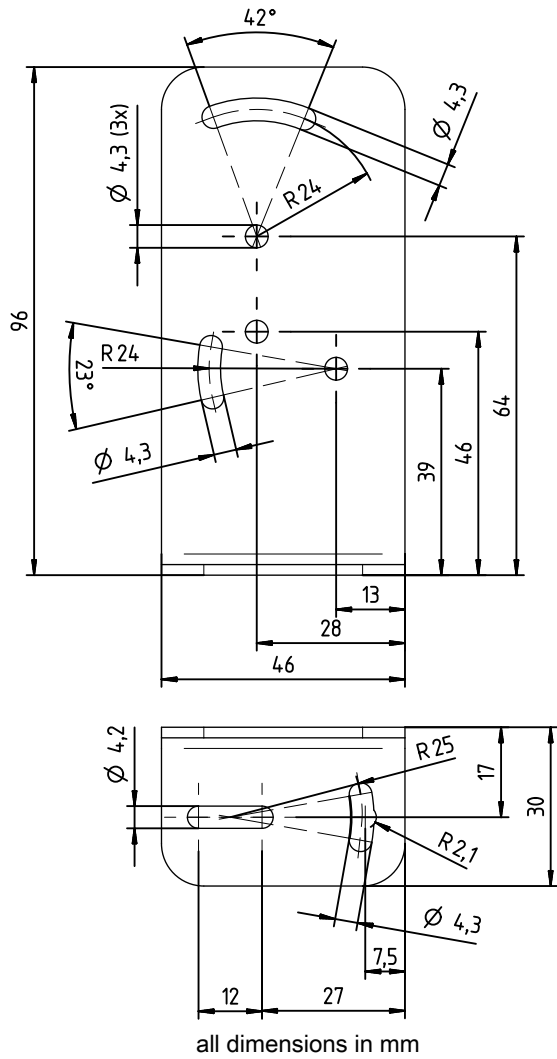

Figure 13.3: Dimensioned drawing mounting bracket BT 300M.5

14 Ordering information and accessories

14.1 Type overview ODS 10

Optical distance sensors, measurement against object

- Maximum measurement range: 8000 mm
- Connection: M12 connector, 5-pin

Part no.	Part designation	Description
50127853	ODS10L1.8/LAK-M12	IO-Link 1.1, analog output, multifunction input, 1 push-pull switching output
50129528	ODS10L1.8/L6X-M12	IO-Link 1.1, 2 push-pull switching outputs
50129529	ODS10L1.8/LA6-M12	IO-Link 1.1, analog output, 2 push-pull switching outputs

Optical distance sensors, measurement against object

- Maximum measurement range: 8000 mm
- Connection: cable, length 2000mm, with wire-end sleeves, 5-wire

Part no.	Part designation	Description
50129531	ODS10L1.8/LAK	IO-Link 1.1, analog output, multifunction input, 1 push-pull switching output
50129532	ODS10L1.8/LA6	IO-Link 1.1, analog output, 2 push-pull switching outputs

Optical distance sensors, measurement against object

- Maximum measurement range: 8000 mm
- Connection: cable, length 200mm, with M12 connector, 5-pin

Part no.	Part designation	Description
50129534	ODS10L1.8/LAK, 200-M12	IO-Link 1.1, analog output, multifunction input, 1 push-pull switching output
50129535	ODS10L1.8/LA6, 200-M12	IO-Link 1.1, analog output, 2 push-pull switching outputs

Optical distance sensor, measurement against reflector

- Maximum measurement range: 25000 mm
- Connection: M12 connector, 5-pin

Part no.	Part designation	Description
50129530	ODS10L1-25M.8/LAK-M12	IO-Link 1.1, analog output, multifunction input, 1 push-pull switching output

Optical distance sensor, measurement against reflector

- Maximum measurement range: 25000 mm
- Connection: cable, length 2000mm, with wire-end sleeves, 5-wire

Part no.	Part designation	Description
50129533	ODS10L1-25M.8/LAK	IO-Link 1.1, analog output, multifunction input, 1 push-pull switching output

Optical distance sensor, measurement against reflector

- Maximum measurement range: 25000 mm
- Connection: cable, length 200mm, with M12 connector, 5-pin

Part no.	Part designation	Description
50129536	ODS10L1-25M.8/LAK 200-M12	IO-Link 1.1, analog output, multifunction input, 1 push-pull switching output

14.2 Accessories – cables and connectors

Table 14.1: Cables and connectors

Part no.	Part designation	Description
50020501	KD 095-5A	M12 connector (cable socket), user-configurable, 5-pin, axial
50020502	KD 095-5	M12 connector (cable socket), user-configurable, 5-pin, angled
50104555	K-D M12A-5P-2m-PVC	Connection cable with M12 connector on one end, 5-pin, M12, axial, length 2 m, PVC sheathing
50104556	K-D M12W-5P-2m-PVC	Connection cable with M12 connector, angled, 5-pin, length 2 m, PVC sheathing
50104557	K-D M12A-5P-5m-PVC	Connection cable with M12 connector on one end, 5-pin, M12, axial, length 5 m, PVC sheathing
50104558	K-D M12W-5P-5m-PVC	Connection cable with M12 connector, angled, 5-pin, length 5 m, PVC sheathing
50104559	K-D M12A-5P-10m-PVC	Connection cable with M12 connector on one end, 5-pin, M12, axial, length 10 m, PVC sheathing
50104560	K-D M12W-5P-10m-PVC	Connection cable with M12 connector, angled, 5-pin, length 10 m, PVC sheathing
50104562	K-D M12W-5P-5m-PUR	PUR connection cable with M12 connector on one end, 5-pin, M12, angled, length 5 m
50104567	K-D M12A-5P-2m-PUR	PUR connection cable with M12 connector on one end, 5-pin, M12, axial, length 2 m
50104568	K-D M12W-5P-2m-PUR	PUR connection cable with M12 connector on one end, 5-pin, M12, angled, length 2 m
50104569	K-D M12A-5P-5m-PUR	PUR connection cable with M12 connector on one end, 5-pin, M12, axial, length 5 m

14.3 Other accessories

Table 14.2: Other accessories

Part no.	Part designation	Description
50111527	REF 7-A-100x100	Reflective tape, self-adhesive, 100 mm x 100 mm
50117251	BTU 300M-D14	Mounting system for mounting on rods Ø 14 mm

Part no.	Part designation	Description
50117252	BTU 300M-D12	Mounting system for mounting on rods Ø 12mm
50117253	BTU 300M-D10	Mounting system for mounting on rods Ø 10mm
50118543	BT 300M.5	Mounting bracket

14.3.1 Accessories – PC connection

Table 14.3: Accessories - PC connection configuration

Part no.	Part designation	Description
IO-Link USB master V2.0		
50121098	SET MD12-US2-IL1.1 + accessories	IO-Link USB master V2.0 Plug-in power supply unit (24 V/24 W) with international adapters High-speed USB 2.0 connection cable; USB A to Mini-USB Data carrier with software, drivers and documentation
50110126	K-DS M12A-M12A-4P-2m-PVC	Interconnection cable with M12 connector on both ends, 4-pin, M12, axial, length 2 m, PVC sheathing

15 EC Declaration of Conformity

The optical distance sensor systems of the ODS 10 series were developed and manufactured in accordance with the applicable European standards and directives.

The manufacturer of the product, **Leuze electronic GmbH + Co. KG** in D-73277 Owen, possesses a certified quality assurance system in accordance with ISO 9001.

