

**O2I103**

O2IIOS-G/D/RS232/E1/E2

Identification systems

**Please note the wiring of the sensor and the sockets (see data sheet) as for 8-pole sockets the core colours are not standardised.**

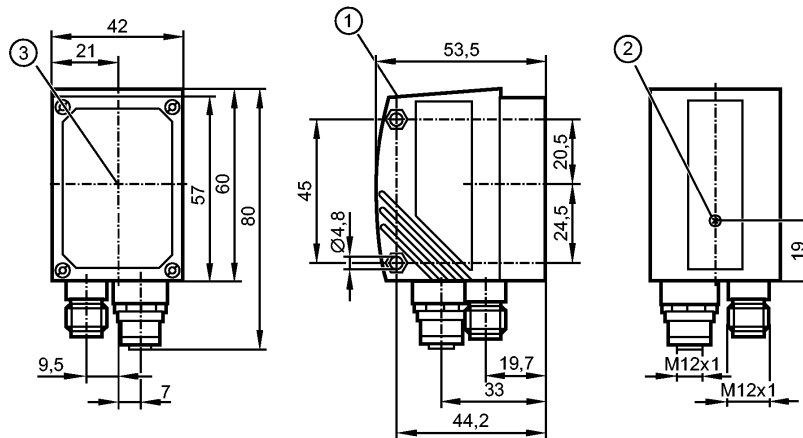

- 1: display
- 2: Focus adjustment screw
- 3: Centre of the lens axes



**Product characteristics**

Multicode Reader	
Max. field of view size: 132 x 94 mm	
integrated, configurable code evaluation	
Process interfaces Ethernet TCP/IP, EtherNet/IP, RS-232	
Parameter setting interfaces Ethernet TCP/IP; UDP/IP	
Integrated lighting: infrared (850 nm)	

**Application**

Readable codes	ECC200, PDF-417, QR Interleaved 2-of-5, Industrial 2-of-5, Code 39, Code 93, Code 128, Pharmacode, Codabar EAN8, EAN8 Add-On 2, EAN8 Add-On 5 EAN13, EAN13 Add-On 2, EAN13 Add-On 5 UPC-A, UPC-A Add-On 2, UPC-A Add-On 5 UPC-E, UPC-E Add-On 2, UPC-E Add-On 5 RSS-14, RSS-14 Truncated, RSS-14 Stacked, RSS-14 Stack Omnidirection, RSS Limited, RSS Expanded, RSS Expanded Stacked
----------------	---

**Electrical data**

Operating voltage	[V]	24 DC ± 10 %
Current consumption	[mA]	300
Protection class		III
Reverse polarity protection		ja *)
Connection external illumination	[V]	24 DC PNP
Type of sensor		CMOS image sensor B/W, VGA resolution 640 x 480

**Inputs**

Trigger	internal external; 24 V PNP to IEC 61131-2 type 1 via RS-232, TCP/IP or EtherNet/IP
---------	---

**Outputs**

Output	max. 2 (configurable) / 24 V PNP
Max. current load per output	[mA] 100

## O2I103

O2IIOS-G/D/RS232/E1/E2

Identification systems

Voltage drop	[V]	< 2
Short-circuit protection		yes
Overload protection		yes

Range				
Operating distance	[mm]	50	100	200
Field of view size	[mm]	33 x 24	66 x 47	132 x 94
Omnidirectional reading		yes		
inclination to the image plane		≤ 45°		
readings	[Hz]	≤ 20		
Motion speed	[m/s]	≤ 7		

Software / programming	
Parameter setting options	via 2 pushbuttons and 10-segment display or via PC / notebook with operating software

Interfaces	
parameter setting interface	Ethernet TCP/UDP/IP; 10Base-T / 100Base-TX
Process interface	Ethernet TCP/IP, EtherNet/IP, RS-232
IP address	192.168.0.79
subnet mask	255.255.255.0 (Class C)
gateway IP address	192.168.0.201
MAC address	see type label

Environment	
Ambient temperature	[°C] -10...50
Storage temperature	[°C] -40...85
Protection	IP 67

Tests / approvals		
EMC	radiation of interference noise immunity	to EN 61326 to EN 61326
MTTF	[Years]	93
Shock resistance		IEC 60028-2-27:
Vibration resistance		IEC 60028-2-6:

Mechanical data	
Housing materials	housing: diecast zinc powder-coated; window: glass; LED window: polycarbonate
Weight	[kg] 0.347

Displays / operating elements	
Display	Function display 3 x LED green 4 x LED yellow Display unit / status 4-digit 10-segment display

Electrical connection	
Connection	M12 plug, 8 poles M12 socket, 4 poles

### Wiring

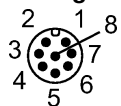

RS-232: Process connection

- 1: U+
- 2: trigger input
- 3: 0 V
- 4: Switching output 1 (code evaluation) / Trigger output (with external illumination)
- 5: RxD RS-232
- 6: TxD RS-232

## O2I103

O2IIOS-G/D/RS232/E1/E2

Identification systems

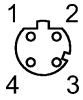

- 7: Switching output 2 (ready signal)
- 8: GND RS-232 (electrically separated up to 50 V)

Ethernet: parameter setting/process connection

- 1: TXD+
- 2: RXD+
- 3: TXD-
- 4: RXD-

### Other technical data

Integrated lighting	infrared (850 nm) segmented in 4 areas (can be activated individually via the PC operating program)
Laser marking	red, laser protection class 2 to DIN EN 60825-1

### Accessories

Accessories (optional)	Operating software; Mounting accessories
------------------------	---

### Remarks

Remarks	cULus - Class 2 source required *) The voltage on pins 2, 4, 5, 6, 7 and 8 must not exceed the supply voltage on pin 1 (U+) (see operating instructions).
---------	--

Pack quantity	[piece]	1
---------------	---------	---

ifm electronic gmbh • Friedrichstraße 1 • 45128 Essen — We reserve the right to make technical alterations without prior notice. — GB — O2I103 — 11.05.2010

**Please note the wiring of the sensor and the sockets (see data sheet) as for 8-pole sockets the core colours are not standardised.**