

# L-GAGE® LTF Time of Flight Laser Distance Sensor

## Instruction Manual

Original Instructions  
194135 Rev. C  
18 November 2016  
© Banner Engineering Corp. All rights reserved



# Contents

1	Product Description	3
1.1	Models	3
1.2	Overview	3
1.2.1	Features and Indicators	4
1.2.2	Display	4
1.2.3	Buttons	4
1.3	Laser Description and Safety Information	5
2	Sensor Installation	7
2.1	Mount the Sensor	7
2.2	Wiring Diagrams	7
3	Sensor Programming	8
3.1	Quick Menu	8
3.2	Sensor Menu (MENU)	9
3.3	Remote Input	9
3.4	Locking and Unlocking the Sensor	11
3.5	Analog Output Menu (A_OUT)	11
3.5.1	TEACH 4 mA (0 V) and TEACH 20 mA (10 V)	12
3.5.2	Midpoint TEACH	13
3.5.3	Adjust 4 mA (0 V)	15
3.5.4	Adjust 20 mA (10 V)	16
3.5.5	Slope	16
3.5.6	Loss of Signal	17
3.6	Discrete Output Menu (D_OUT)	18
3.6.1	Two-Point TEACH	18
3.6.2	Midpoint TEACH	20
3.6.3	Adjust Switch Point One	22
3.6.4	Adjust Switch Point Two	22
3.6.5	TEACH Switch Point	22
3.6.6	Adjust Switch Point	23
3.6.7	Mode	23
3.6.8	Switch Point Reference (SPtRef)	25
3.6.9	Switch Point TEACH Offset	25
3.6.10	Timer	26
3.6.11	Polarity	26
3.7	Input Menu (INPUT)	26
3.7.1	Input Type	27
3.7.2	Input Active	27
3.8	Measure Menu (MEASURE)	27
3.8.1	Speed	28
3.8.2	Trigger	28
3.9	Display Menu (DISPLAY)	30
3.9.1	Units	30
3.9.2	Zero and Shift	30
3.9.3	View	31
3.9.4	Sleep	32
3.10	Information Menu (INFO)	32
3.11	Reset Menu (RESET)	33
3.11.1	Factory Default Settings	33
4	Sync Master/Slave	34
5	Additional Remote TEACH Procedures	35
5.1	TEACH Analog Output and Discrete Output Switch Points Together	35
5.2	TEACH Analog Output and Discrete Output Midpoints Together	35
6	Specifications	37
6.1	Repeatability Performance	38
6.2	Dimensions	40
7	Troubleshooting	41
8	Sensor Menu Full Map	42
9	Accessories	43
9.1	Cordsets	43
9.2	Brackets	43
10	Banner Engineering Corp. Limited Warranty	44

# 1 Product Description

Laser distance sensor with both analog and discrete (switched) outputs

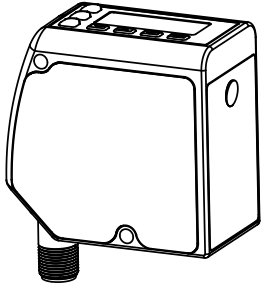

- High performance time of flight measurement
- Extended 12 m range
- Reliably detects challenging targets
- Fast set up with intuitive interface



**WARNING: Not To Be Used for Personnel Protection**

Never use this device as a sensing device for personnel protection. Doing so could lead to serious injury or death. This device does not include the self-checking redundant circuitry necessary to allow its use in personnel safety applications. A sensor failure or malfunction can cause either an energized or de-energized sensor output condition.

## 1.1 Models

Family	Range (m)	Output	Laser Class	Sensing Mode	Connector
<b>LTF</b>	<b>12</b>	<b>I</b>	<b>C2</b>	<b>LD</b>	<b>Q</b>
	12	I = 4 to 20 mA analog and (1) NPN/PNP discrete  U = 0 to 10 V analog and (1) NPN/PNP discrete	C2 = Class 2	LD = Laser diffuse	Blank = 2 m Integral Cable Q = Rotatable M12/Euro QD QP = PVC M12/Euro Pigtail QD W/30 = 9 m Integral Cable <i>QD models require mating cordset</i>

## 1.2 Overview

The LTF Time of Flight Laser Distance Sensor is designed for precise, long-distance measurements. A 2-line LCD shows the real-time distance measurement, in either millimeters or inches, and the analog output measurement, in milliamps or volts, when the sensor is in Run mode.

See *Factory Defaults* for a list of sensor default settings.

Models with current or voltage analog outputs are available. This manual provides the display information and the navigation paths for the current models with the voltage model text in parentheses if it is different.

## 1.2.1 Features and Indicators

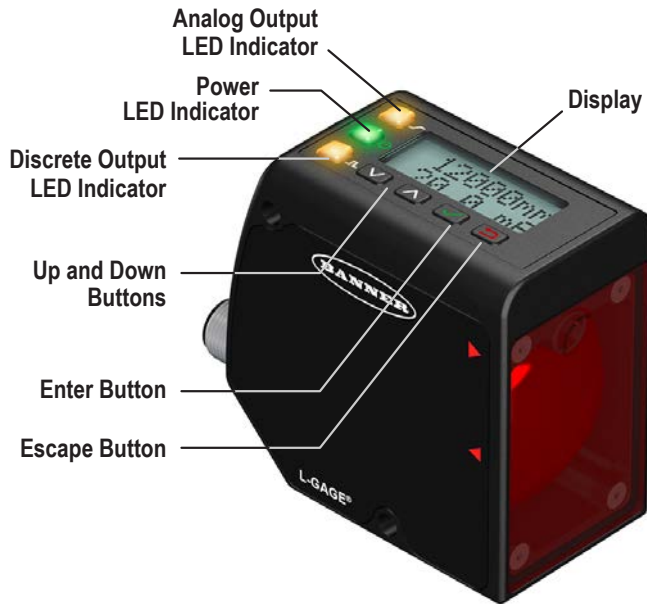

Figure 1. Features

Three LED indicators provide ongoing indication of the sensing status.

### Analog Output LED Indicator

Solid Amber = Displayed distance is within the taught analog output window  
Off = Displayed distance is outside the taught analog output window

### Power LED Indicator

Solid Green = Normal operation, power On and laser On  
Flashing Green (1 Hz) = Power On and laser Off (laser enable mode)

### Discrete Output LED Indicator

Solid Amber = Discrete Output is On  
Off = Discrete Output is Off

## 1.2.2 Display



Figure 2. Display shown in Run Mode

The display is a 2-line, 8-character LCD. The main screen is the Run mode screen, which shows the real-time distance measurement and the analog output measurement.

## 1.2.3 Buttons

Use the sensor buttons Down, Up, Enter, and Escape to program the sensor and to access sensor information.



### Down and Up Buttons

Press Down and Up to:

- Access the Quick Menu from Run mode
- Navigate the menu systems
- Change programming settings
- Change individual digit values in distance based settings

When navigating the menu systems, the menu items loop.



### Enter Button

Press Enter to:

- Access the Sensor Menu from Run mode
- Access the submenus
- Move right one digit in distance based settings
- Save changes

In the Sensor Menu, a check mark  in the lower right corner of the display indicates that pressing Enter accesses a submenu.

Press Enter to save changes. New values flash rapidly and the sensor returns to the parent menu.



### Escape Button

Press Escape to:

- Leave the current menu and return to the parent menu
- Return to Run mode from the Quick Menu



Important: Pressing Escape discards any unsaved programming changes.

In the Sensor Menu, a return arrow  in the upper left corner of the display indicates that pressing Escape returns to the parent menu.

Press and hold Escape for 2 seconds to return to Run mode from any menu or remote teach.

## 1.3 Laser Description and Safety Information



CAUTION: Use of controls or adjustments or performance of procedures other than those specified herein may result in hazardous radiation exposure. Do not attempt to disassemble this sensor for repair. A defective unit must be returned to the manufacturer.

### 1.3 Class 2 Laser Models



CAUTION: Never stare directly into the sensor lens. Laser light can damage your eyes. Avoid placing any mirror-like object in the beam. Never use a mirror as a retroreflective target.



#### For Safe Laser Use - Class 2 Lasers

- Do not stare at the laser.
- Do not point the laser at a person's eye.
- Mount open laser beam paths either above or below eye level, where practical.
- Terminate the beam directly by the laser product at the end of its useful path.

Reference IEC 60825-1:2007, Section 8.2.

#### Class 2 Lasers

Class 2 lasers are lasers that emit visible radiation in the wavelength range from 400 nm to 700 nm, where eye protection is normally afforded by aversion responses, including the blink reflex. This reaction may be expected to provide adequate protection under reasonably foreseeable conditions of operation, including the use of optical instruments for intrabeam viewing.



Figure 3. FDA (CDRH) warning label (Class 2)

### Class 2 Laser Safety Notes

Low-power lasers are, by definition, incapable of causing eye injury within the duration of a blink (aversion response) of 0.25 seconds. They also must emit only visible wavelengths (400 to 700 nm). Therefore, an ocular hazard may exist only if individuals overcome their natural aversion to bright light and stare directly into the laser beam.

## 2 Sensor Installation



NOTE: Handle the sensor with care during installation and operation. Sensor windows soiled by fingerprints, dust, water, oil, etc. may create stray light that may degrade the peak performance of the sensor. Blow the window clear using filtered, compressed air, then clean as necessary using 70% isopropyl alcohol and cotton swabs or water and a soft cloth.

### 2.1 Mount the Sensor

1. If a bracket is needed, mount the sensor onto the bracket.
2. Mount the sensor (or the sensor and the bracket) to the machine or equipment at the desired location. Do not tighten the mounting screws at this time.
3. Check the sensor alignment.
4. Tighten the mounting screws to secure the sensor (or the sensor and the bracket) in the aligned position.

### 2.2 Wiring Diagrams

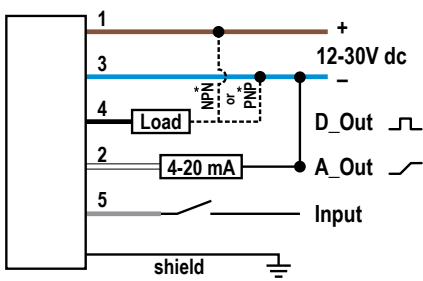

\* User-configurable PNP/NPN setting

Figure 4. Analog Current Model

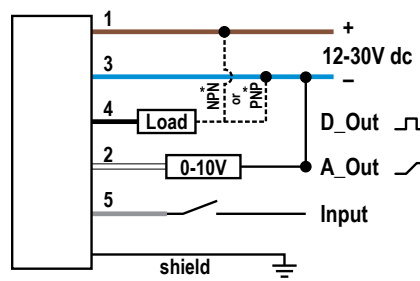

\* User-configurable PNP/NPN setting

Figure 5. Analog Voltage Model

Key

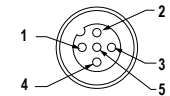

- 1 = Brown
- 2 = White
- 3 = Blue
- 4 = Black
- 5 = Gray

## 3 Sensor Programming

Program the sensor using the buttons on the sensor or the remote input (limited programming options).

From Run mode, use the buttons to access the Quick Menu and the Sensor Menu. See [Quick Menu](#) on page 8 and [Sensor Menu \(MENU\)](#) on page 9 for more information on the options available from each menu. For TEACH options, follow the TEACH instructions.

In addition to programming the sensor, use the remote input to disable the buttons for security, preventing unauthorized or accidental programming changes. See [Remote Input](#) on page 9 for more information.

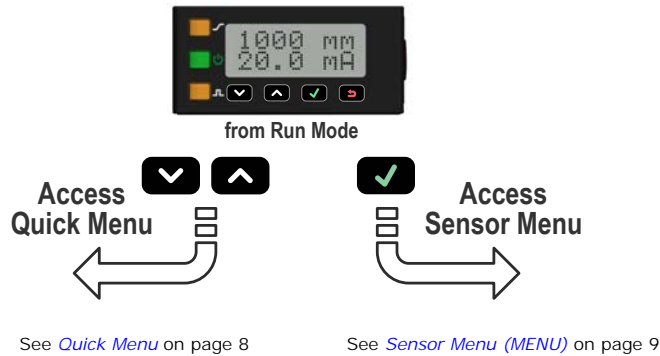

Figure 6. Accessing the Menus

### 3.1 Quick Menu

The sensor includes a Quick Menu with easy access to view and change the analog and discrete output switch points.

Access the Quick Menu by pressing Down (v) or Up (^) from Run mode. When in the Quick Menu, the current distance measurement displays on the first line and the menu name and the analog value alternate on the second line of the display. Press Enter (✓) to access the switch points. Press Down and Up to change each digit. Press Enter to move right one digit. After reviewing each digit, press Enter again to save the new value and return to the Quick Menu. Press Cancel to ignore any changes made if only some digits have been changed.

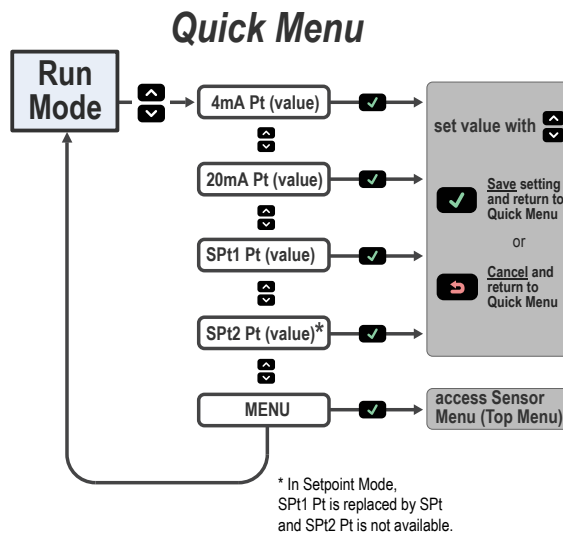



Figure 7. Quick Menu Map (Window Mode)



## 3.2 Sensor Menu (MENU)

Access the Sensor Menu by pressing Enter  from Run mode. The Sensor Menu is also accessible from the Quick Menu: navigate to MENU and press Enter . The Sensor Menu includes several submenus that provide access to view and change sensor settings and to view sensor information.

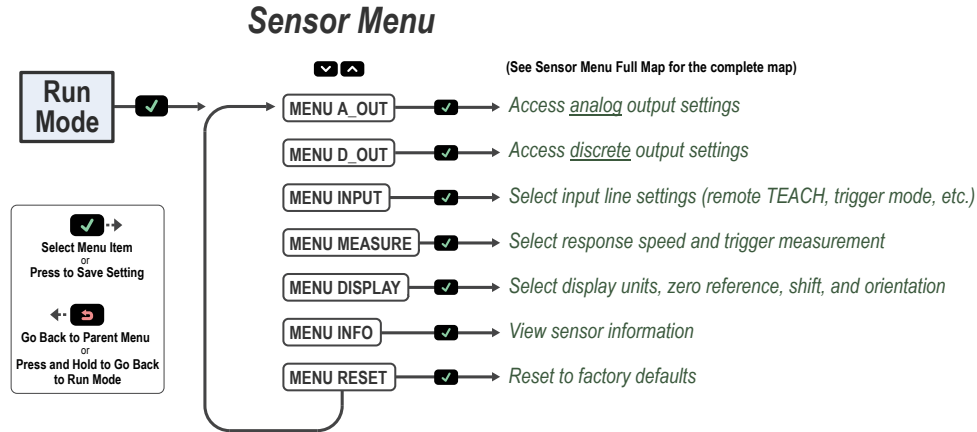

Figure 8. Sensor Menu Basic Map

See *Sensor Menu Full Map* and the Menu sections of this manual for more information.

## 3.3 Remote Input

Use the remote input to program the sensor remotely. The remote input is disabled by default. Activate remote input using the buttons to navigate to the Input Type menu option.

The remote input provides limited programming options and is Active Low by default. For Active Low, connect the gray input wire to ground (0 V dc), with a remote switch connected between the wire and ground. To use the Active High function, configure the sensor for Active High using the buttons on the sensor, then connect the gray input wire to V+ (12 to 30 V dc). Pulse the remote input according to the diagram and the instructions provided in this manual.

The length of the individual programming pulses is equal to the value T:  $0.04 \text{ seconds} \leq T \leq 0.8 \text{ seconds}$ .

Exit remote programming modes by holding the remote input low for > 2 seconds, or waiting for the automatic 60-second timeout, or by pressing and holding Escape  for 2 seconds. The sensor returns to Run mode without saving any new settings.

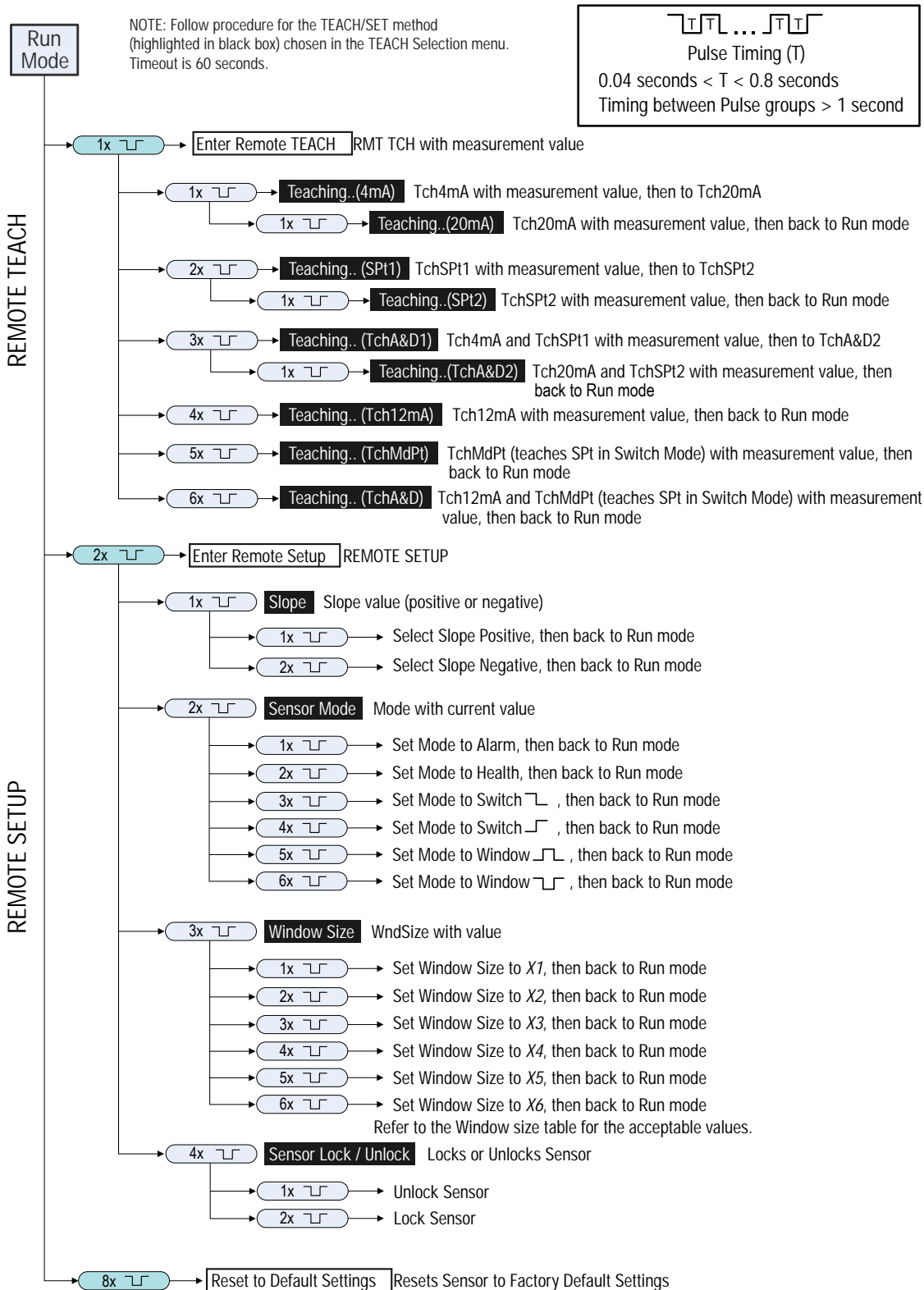



Figure 9. Remote Input Map



Table 1: Remote TEACH Window Sizes

Variable	Remote TEACH Window Size	Variable	Remote TEACH Window Size
X1	10 mm	X4	500 mm
X2	20 mm	X5	2000 mm
X3	100 mm	X6	11950 mm

### 3.4 Locking and Unlocking the Sensor

Use the lock and unlock feature to prevent unauthorized or accidental programming changes. A lock symbol  displays in the upper left corner of the display to indicate when the sensor is locked. When locked, the menus are available to view settings, but the values cannot be changed. The remote input is also disabled, except for the unlock function.

#### Button Instructions

To lock or unlock the sensor using the buttons, press and hold Down  and Escape  simultaneously for 3 seconds.

#### Remote Input Instructions

1. Access the setup mode.

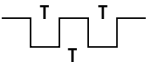
Action		Result
Double-pulse the remote input.		"REMOTE SETUP" displays.

2. Access the lock/unlock function.

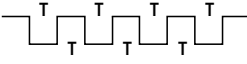
Action		Result
Four-pulse the remote input.		"LOCK" and the current status (unlocked or locked) display.

3. Lock or unlock the sensor.

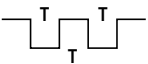
Action		Result
Unlock : Single-pulse the remote line.		"Unlocked" flashes and the sensor returns to Run mode. The sensor is unlocked.
Lock: Double-pulse the remote input.		"Locked" flashes and the sensor returns to Run mode. The sensor is locked and the lock symbol displays in the upper left corner.

### 3.5 Analog Output Menu (A\_OUT)

Use the Analog Output menu to view or change:

- 4 mA (0 V) setpoint
- 20 mA (10 V) setpoint
- 12 mA (5 V) window
- Slope
- Loss of signal behavior

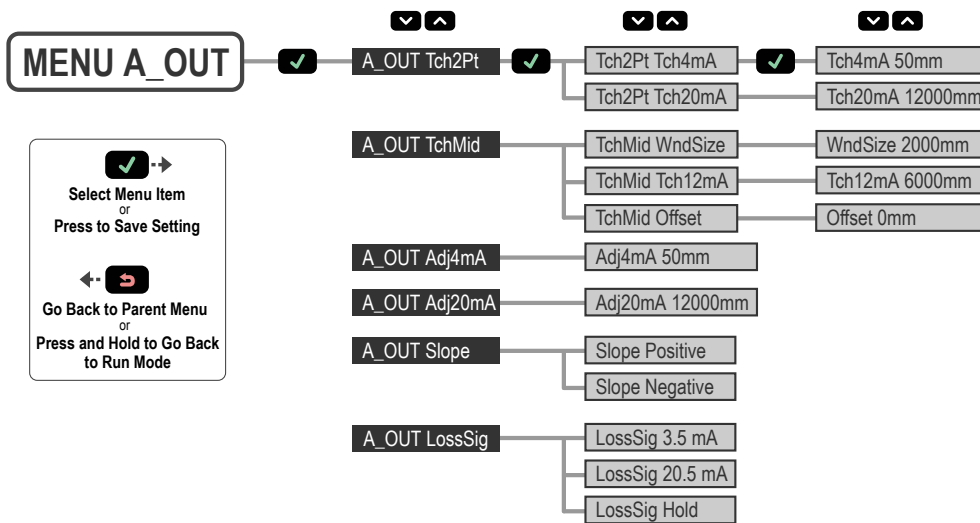

Figure 10. Analog Output Menu Map

### 3.5.1 TEACH 4 mA (0 V) and TEACH 20 mA (10 V)

The Tch4mA (Tch0V) and Tch20mA (Tch10V) options use targets to set the 4 mA (0 V) and 20 mA (10 V) to the desired setpoints. When using the buttons, only one value needs to be set if the second value is valid. When using the remote input, both values must be set.

Navigate: MENU > A\_OUT > Tch2Pt > Tch4mA (Tch0V) or navigate: MENU > A\_OUT > Tch2Pt > Tch20mA (Tch10V)

Remote input: Available

#### Button Instructions

1. Present the target.

Action	Result
Present the target. The target must be within the sensor's measurement range.	The target's analog output measurement and distance measurement values display.

2. Access the TEACH mode and TEACH the sensor.

Action	Result
Navigate: MENU > A_OUT > Tch2Pt > Tch4mA (Tch0V) OR Navigate: MENU > A_OUT > Tch2Pt > Tch20mA (Tch10V)	The selected TEACH mode and "Teaching" display while the sensor is being taught.  <u>TEACH Accepted</u>  The new value is shown on the second line of the display and flashes before it is saved and the sensor returns to the parent menu.  <u>TEACH Not Accepted</u>  "FAIL" and a warning message display, and the sensor returns to the parent menu.

3. Repeat steps 1 to 2 for the other setpoint, if desired.

#### Remote Input Instructions

Teaches both the 4 mA (0 V) and 20 mA (10 V) setpoints.

1. Access the TEACH mode.

Action	Result
Single-pulse the remote input.	"RMT TCH" and the current measurement value display.



2. Present the target.

Action	Result
Present the 4 mA (0 V) target.	"RMT TCH" and the target's measurement value display.

3. TEACH the sensor.

Action	Result
Single-pulse the remote input. 	"Tch4mA (Tch0V) Teaching" displays while the sensor is being taught. <u>TEACH Accepted</u> The new value displays on the second line of the display, flashes, and then "Tch20mA (Tch10V)" and the current measurement value display. <u>TEACH Not Accepted</u> "FAIL" flashes, the sensor returns to step 2, and "RMT TCH" displays.

4. Present the target.

Action	Result
Present the 20 mA (10 V) target.	"Tch20mA (Tch10V)" and the target's measurement value display.

5. TEACH the sensor.

Action	Result
Single-pulse the remote input. 	"Tch20mA (Tch10V) Teaching" displays while the sensor is being taught. <u>TEACH Accepted</u> The new value displays on the second line of the display, flashes, and the sensor returns to Run mode. <u>TEACH Not Accepted</u> "FAIL" flashes, the sensor returns to step 2, and "RMT TCH" displays.

### 3.5.2 Midpoint TEACH

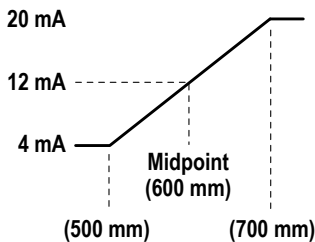

Figure 11. Window and Midpoint Example

The Midpoint TEACH uses both the window size and the 12 mA (5 V) setpoint to determine the actual measurement window. For example, a window of 200 mm with a 12 mA (5 V) setpoint of 600 mm places the measurement window from 500 mm to 700 mm.

To use the Midpoint TEACH:

1. Set the window size.
2. Set the measurement window using [TEACH 12 mA \(5 V\)](#) on page 14.

The Analog Output Midpoint TEACH and the Discrete Output Midpoint TEACH are independent settings (see [Midpoint TEACH](#) on page 20).

### Window Size

The `A_OUT > TchMid > WndSize` option sets the window size that the Midpoint TEACH uses to set the 4 mA (0 V) and 20 mA (10 V) setpoints.

The taught surface must be inside the defined sensing range, and at least one setpoint (with offset applied, if any) must be located within the sensing range.

The Analog Output window size is a different setting than the Discrete Output window size when defined using the push buttons.

Window Size Minimum	10 mm
Window Size Maximum	11950 mm
Range	50 mm to 12000 mm
Default Window Size	2000 mm

Navigate: MENU > A\_OUT > TchMid > WndSize

Remote Input: Available

1. Access the Window Size mode.

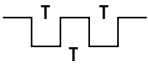
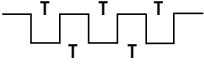
Method	Action	Result
Push Button	Navigate: MENU > A_OUT > TchMid > WndSize	"WndSize" and the current window size value display.
Remote Input	<p>a. Double-pulse the remote input to enter setup mode.</p>  <p>b. Three-pulse the remote input to enter window size mode.</p> 	<p>a. "REMOTE SETUP" displays.</p> <p>b. "WndSize" and the current window size value display.</p>

2. Set the window size.

Method	Action	Result														
Push Button	<p>a. Use the Up and Down buttons to set the desired window size—the value changes in increments of 2.</p> <p>b. Press Enter  to save the new value.</p>	<p>a. "WndSize" and the new value display.</p> <p>b. The new value flashes and the sensor returns to "TchMid WndSize".</p>														
Remote Input (Sets A_OUT and D_OUT window Size)	<p>Pulse the remote input 1 to 6 times to select the desired window size.</p> <table border="1" data-bbox="407 1276 1130 1562"> <thead> <tr> <th>Pulses</th> <th>Window Size</th> </tr> </thead> <tbody> <tr> <td>1</td> <td>10 mm</td> </tr> <tr> <td>2</td> <td>20 mm</td> </tr> <tr> <td>3</td> <td>100 mm</td> </tr> <tr> <td>4</td> <td>500 mm</td> </tr> <tr> <td>5</td> <td>2000 mm</td> </tr> <tr> <td>6</td> <td>11950 mm</td> </tr> </tbody> </table>	Pulses	Window Size	1	10 mm	2	20 mm	3	100 mm	4	500 mm	5	2000 mm	6	11950 mm	<p>The new value flashes and the sensor returns to Run mode.</p>
Pulses	Window Size															
1	10 mm															
2	20 mm															
3	100 mm															
4	500 mm															
5	2000 mm															
6	11950 mm															

## TEACH 12 mA (5 V)

The Tch12mA (Tch5V) option sets the midpoint that determines the actual measurement window.

Navigate: MENU > A\_OUT > TchMid > Tch12mA (Tch5V)

Remote Input: Available

Button Instructions

1. Present the target.

Action	Result
Present the target.	The target's analog output measurement and distance measurement values display.

2. Access the TEACH 12 mA (5 V) mode and TEACH the sensor.

Action	Result
Navigate: MENU > A_OUT > TchMid > Tch12mA (Tch5V) .	<p>"Tch12mA (Tch5V) Teaching" displays while the sensor is being taught.</p> <p><u>TEACH Accepted</u></p> <p>The new value is shown on the second line of the display and flashes before it is saved and the sensor returns to "TchMid Tch12mA (Tch5V)".</p> <p><u>TEACH Not Accepted</u></p> <p>"FAIL" and a warning message display and the sensor returns to "Tch Mid Tch12mA (Tch5V)".</p>

### Remote Input Instructions

1. Access the TEACH mode.

Action	Result
Single-pulse the remote input. 	"RMT TCH" and the current measurement value display.

2. Present the target.

Action	Result
Present the target.	"RMT TCH" and the target's measurement value display.

3. TEACH the sensor.

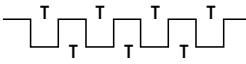
Action	Result
Four-pulse the remote input. 	<p>"Tch12mA (Tch5V) Teaching" displays while the sensor is being taught.</p> <p><u>TEACH Accepted</u></p> <p>The new value displays on the second line of the display, flashes, and the sensor returns to Run mode</p> <p><u>TEACH Not Accepted</u></p> <p>"FAIL" flashes, the sensor returns step 2, and "RMT TCH" displays.</p>

### Window TEACH Offset

Use the A\_OUT > TchMid > Offset menu to set an offset from the taught distance used during a 12 mA (5 V) TEACH. By default, the value is 0 mm because the window is centered around the taught distance. A positive offset value always shifts the window towards the sensor.

### 3.5.3 Adjust 4 mA (0 V)

The Adj4mA (Adj0V) option manually adjusts the distance at which the Analog Output is 4mA (0 V). The value is adjustable within the sensor's range. It is required to at least maintain the minimum window size.

Navigate: MENU > A\_OUT > Adj4mA (Adj0V)

Remote Input: Not available

Default: 50 mm

### 3.5.4 Adjust 20 mA (10 V)

The Adj20mA (Adj10V) option manually adjusts the distance at which the Analog Output is 20 mA (10 V). The value is adjustable between the sensor's range. It is required to at least maintain the minimum window size.

Navigate: MENU > A\_OUT > Adj20mA (Adj10V)

Remote Input: Not available

Default: 12000 mm

### 3.5.5 Slope

The Slope option sets the slope as positive or negative. This swaps the 4 mA and 20 mA (0 V and 10 V) values.

Navigate: MENU > A\_OUT > Slope

Remote Input: Available

Default: Positive

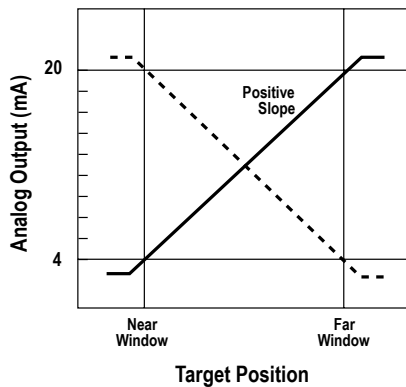

The analog current output tracks slightly beyond each window limit (from 3.8 mA to 20.2 mA)

Figure 12. Slope—Current-Sourcing Models

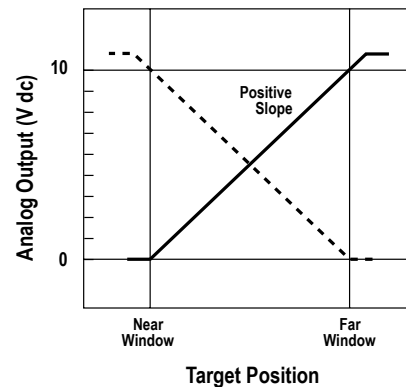

The analog voltage output tracks slightly beyond the upper window limit (up to 10.2 V)



Figure 13. Slope—Voltage-Sourcing Models

1. Access the slope setting.

Method	Action	Result
Push Button	Navigate: MENU > A_OUT > Slope	"Slope" and the current setting display.
Remote Input	a. Double-pulse the remote input to enter setup mode.	a. "REMOTE SETUP" displays.
	b. Single-pulse the remote input to access A_OUT Slope.	b. "Slope" and the current setting display.

2. Set the slope.

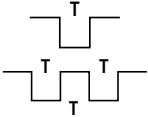

Method	Action	Result
Push Button	a. Use Down  and Up  to change the slope between Positive and Negative.  b. Press Enter  to save the selection.	a. The selection flashes rapidly on the display.  b. The selection is saved and the sensor returns to "A_OUT Slope".
Remote Input	Positive slope: Single-pulse the remote input Negative slope: Double-pulse the remote input 	The selection flashes rapidly on the display, and the sensor returns to Run mode.

### 3.5.6 Loss of Signal

The LossSig option sets the Analog Output value used by the sensor during a loss of signal. When a signal is restored, measurement resumes.

Navigate: Menu > A\_Out > LossSig

Remote Input: Not available

Default: 3.5 mA (0 V)

Option	Description
3.5 mA (0 V)	The Analog Output switches to this value 2 seconds after a loss of signal. When advanced measurements are enabled, the Analog Output is updated to this value immediately upon the release of the trigger input. For Voltage models, this is 0 V. (Default)
20.5 mA (10.5 V)	The Analog Output switches to this value 2 seconds after a loss of signal. When advanced measurements are enabled, the Analog Output is updated to this value immediately upon the release of the trigger input. For Voltage models, this is 10.5 V.
Hold	The Analog Output holds the last value indefinitely during a loss of signal. When advanced measurements are enabled, the last value is held across the triggered measurement periods.

The Range advanced measurement behavior is affected by the Loss of Signal option. For additional information on advanced measurements, see [Trigger](#) on page 28. The Range advanced measurement tracks a maximum and a minimum during the measurement period, and calculates the range as follows:

$$\text{Range} = \text{maximum distance} - \text{minimum distance}$$

If the maximum and/or minimum measurements are outside of the taught setpoints, the Loss of Signal option determines how the range is calculated.

Option	Sensor Behavior in Range Mode
3.5 mA (0 V)	If the maximum or minimum measurement is outside of the taught setpoints, the sensor outputs 3.5 mA (0 V) to indicate an out of range measurement.
20.5 mA (10.5 V)	If the maximum or minimum measurement is outside of the taught setpoints, the sensor outputs 20.5 mA (10.5 V) to indicate an out of range measurement.
Hold	The sensor limits the maximum and minimum measurements so that they cannot exceed the taught setpoints.

### 3.6 Discrete Output Menu (D\_OUT)

Use this menu to view or change

- Setpoints
- Midpoint
- Mode
- Timers
- Polarity

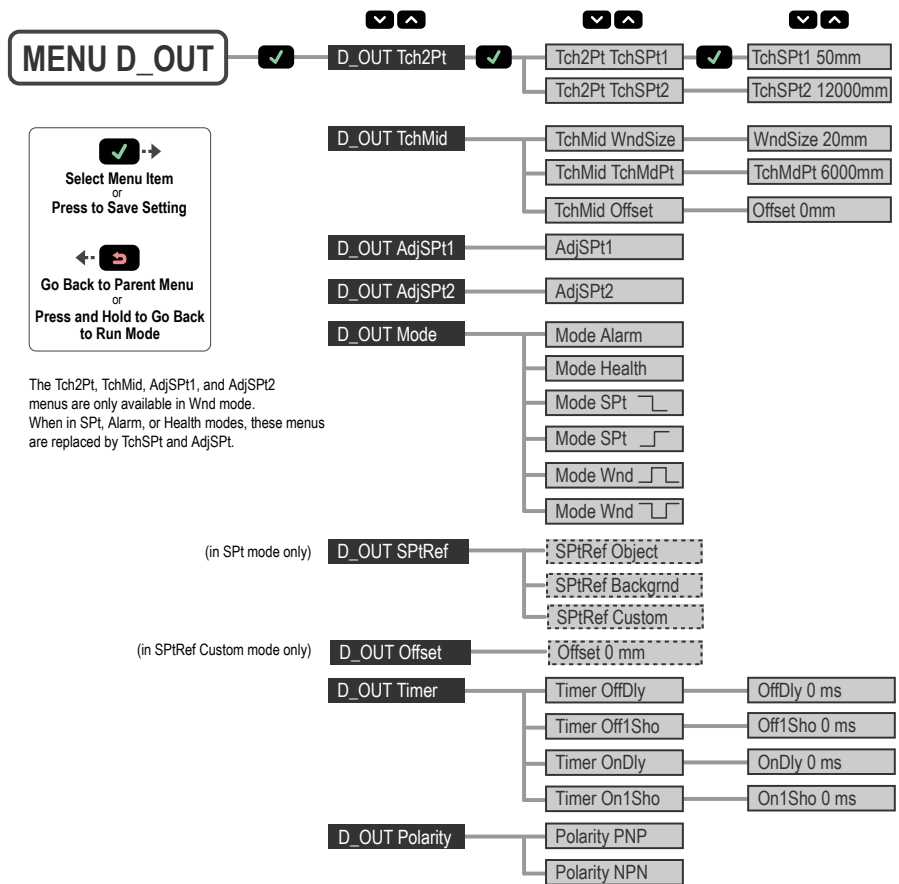

Figure 14. Discrete Output Menu Map

#### 3.6.1 Two-Point TEACH

The TchSpt1 and TchSpt2 options teach the desired switch points. When using the buttons, the switch points can be taught independently. Both values must be taught when using the remote input.



NOTE: When in Switch mode, use *TEACH Switch Point* on page 22.

Navigate: MENU > D\_OUT > Tch2Pt > TchSPT1 and navigate: MENU > D\_OUT > Tch2Pt > TchSPT2

Remote Input: Available

Button Instructions

1. Present the target.

Action	Result
Present the target. The target must be within the sensor's range..	The target's analog output measurement and distance measurement value display.

2. Access the TEACH mode and TEACH the sensor.

Action	Result
Navigate: MENU > D_OUT > Tch2Pt > TchSPt1 OR Navigate: MENU > D_OUT > Tch2Pt > TchSPt2	The selected TEACH mode and "Teaching" display while the sensor is being taught. <u>TEACH Accepted</u> The new value is shown on the second line of the display and flashes before it is saved and the sensor returns to the parent menu. <u>TEACH Not Accepted</u> "FAIL" and a warning message display, and the sensor returns to the parent menu.

- Repeat steps 1 to 2 for the other switch point, if desired.

Remote Input Instructions

- Access the TEACH mode.

Action	Result
Single-pulse the remote input. 	"RMT TCH" and the current switch point value displays.

- Present the target.

Action	Result
Present the switch point one target.	"RMT TCH" and the target's measurement value display.

- TEACH the sensor.

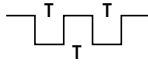
Action	Result
Double-pulse the remote input. 	"TchSPt1 Teaching" displays while the sensor is being taught. <u>TEACH Accepted</u> The new value displays on the second line of the display, flashes, and the sensor goes to "TchSPt2" and the current measurement value. <u>TEACH Not Accepted</u> "FAIL" flashes, the sensor returns to step 2, and "RMT TCH" displays.

- Present the target.

Action	Result
Present the switch point two target.	"TchSPt2" and the target's measurement value display.

- TEACH the sensor.

Action	Result
Single-pulse the remote input. 	"TchSPt2 Teaching" displays while the sensor is being taught. <u>TEACH Accepted</u> The new value displays on the second line of the display, flashes, and the sensor returns to Run mode. <u>TEACH Not Accepted</u> "FAIL" flashes, the sensor returns to step 2, and "RMT TCH" displays.

### 3.6.2 Midpoint TEACH

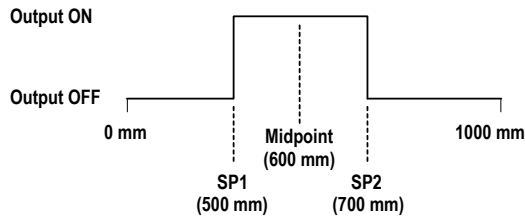

Figure 15. Window and Midpoint Example

The Midpoint TEACH uses both the window size and the TEACH midpoint to determine the actual measurement window. For example, a window of 200 mm with a midpoint of 600 mm places the measurement window from 500 mm to 700 mm.

To use Midpoint TEACH:

1. Set the window size.
2. Set the measurement window using [TEACH Midpoint](#) on page 21.

The Discrete Output Midpoint TEACH and the Analog Output Midpoint TEACH are independent settings.

### Window Size

The D\_OUT > TchMid > WndSize option sets the window size that the Midpoint TEACH uses to set the setpoint one and setpoint two thresholds.

The taught surface must be inside the defined sensing range, and at least one setpoint (with offset applied, if any) must be located within the sensing range.

The Discrete Output window size is a different setting than the Analog Output window size when defined using the push buttons.

Window Size Minimum	10 mm
Window Size Maximum	11950 mm
Range	50 mm to 12000 mm
Default Window Size	20 mm



Navigate: MENU > D\_OUT > TchMid > WndSize

Remote Input: Available

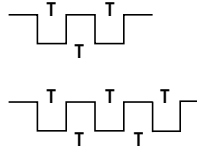
1. Access the setup mode.

Method	Action	Result
Push Button	Navigate: MENU > D_OUT > TchMid > WndSize .	"WndSize" and the current window size value display.
Remote Input	a. Double-pulse the remote input to enter setup mode. b. Three-pulse the remote input to enter window size mode.	 a. "REMOTE SETUP" displays. b. "WndSize" and the current value display.

2. Set the window size.

Method	Action	Result
Push Button	a. Use Down  and Up  to set the desired window size—the value changes in increments of 2. b. Press Enter  to save the new value.	a. "WndSize" and the new value display. b. The new value flashes and returns to "TchMid WndSize".

Method	Action	Result															
Remote Input (Sets A_OUT and D_OUT window Size)	Pulse the remote input 1 to 6 times to select the desired window size.	The new value flashes and the sensor returns to Run mode.															
	<table border="1"> <thead> <tr> <th>Pulses</th> <th>Window Size</th> </tr> </thead> <tbody> <tr> <td>1</td> <td>10 mm</td> </tr> <tr> <td>2</td> <td>20 mm</td> </tr> <tr> <td>3</td> <td>100 mm</td> </tr> <tr> <td>4</td> <td>500 mm</td> </tr> <tr> <td>5</td> <td>2000 mm</td> </tr> <tr> <td>6</td> <td>11950 mm</td> </tr> </tbody> </table>		Pulses	Window Size	1	10 mm	2	20 mm	3	100 mm	4	500 mm	5	2000 mm	6	11950 mm	
	Pulses		Window Size														
	1		10 mm														
	2		20 mm														
	3		100 mm														
	4		500 mm														
5	2000 mm																
6	11950 mm																

## TEACH Midpoint

The TchMdPt option sets the midpoint that determines the actual measurement window.

Navigate: MENU > D\_OUT > TchMid > TchMdPt

Remote Input: Available

Button Instructions

1. Present the target.

Action	Result
Present the target.	The target's analog output measurement and distance measurement value display.

2. Access the TEACH midpoint mode and TEACH the sensor.

Action	Result
Navigate: MENU > D_OUT > TchMid > TchMdPt	<p>"TchMdPt Teaching" displays while the sensor is being taught.</p> <p><u>TEACH Accepted</u></p> <p>The new value is shown on the second line of the display and flashes before it is saved and the sensor returns to "TchMid TchMdPt".</p> <p><u>TEACH Not Accepted</u></p> <p>"FAIL" and a warning message display, and the sensor returns to "TchMid TchMdPt".</p>

Remote Input Instructions

1. Access the TEACH mode.

Action	Result
Single-pulse the remote input. 	"RMT TCH" and the current measurement value display.

2. Present the target.

Action	Result
Present the target.	"RMT TCH" and the target's measurement value display.

3. TEACH the sensor.

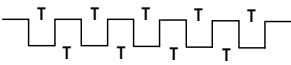
Action	Result
Five-pulse the remote input. 	"TchMdpt Teaching" displays while the sensor is being taught. <u>TEACH Accepted</u> The new value displays on the second line of the display, flashes, and the sensor returns to Run mode. <u>TEACH Not Accepted</u> "FAIL" and a warning message display, the sensor returns to step 2, and "RMT TCH" displays.

### Window TEACH Offset

Use the D\_OUT > TchMid > Offset menu to set an offset from the taught distance used during a Midpoint TEACH. By default, the value is 0 mm because the window is centered around the taught distance. A positive offset value always shifts the window towards the sensor.

### 3.6.3 Adjust Switch Point One

The AdjSPt1 option manually adjusts the value of the switch point one threshold for the Discrete Output when the sensor is in Window mode. The value is adjustable within the sensor's range. It is required to be maintain the minimum window size between switch points. This menu is not available when the sensor is in Switch, Alarm, or Health mode.

Navigate: MENU > D\_OUT > AdjSPt1

Remote Input: Not available

Default: 50 mm

### 3.6.4 Adjust Switch Point Two

The AdjSPt2 option manually adjusts the value of the switch point two threshold for the Discrete Output when the sensor is in Window mode. The value is adjustable with the sensor's range. It is required to be maintain the minimum window size between switch points. This menu is not available when the sensor is in Switch, Alarm, or Health mode.

Navigate: MENU > D\_OUT > AdjSPt2

Remote Input: Not available

Default: 12000 mm

### 3.6.5 TEACH Switch Point

The TchSPt option teaches the distance at which the switch point threshold is placed when the Discrete Output is in Switch mode. This menu is not available when the sensor is in Window, Alarm, or Health mode.

Navigate: MENU > D\_OUT > TchSPt

Remote Input: Available

Button Instructions

1. Present the target.

Action	Result
Present the target. The target must be within the sensor's range.	The target's analog output measurement and distance measurement value display.

2. Access the switch point TEACH mode and TEACH the sensor.

Action	Result
Navigate: MENU > D_OUT > TchSPt	"TchSPt Teaching" displays while the sensor is being taught. <u>TEACH Accepted</u> The new value is shown on the second line of the display and flashes before it is saved and the sensor returns to "D_OUT TchSPt". <u>TEACH Not Accepted</u> "FAIL" and a warning message display, and the sensor returns to "D_OUT TchSPt".

### Remote Input Instructions

1. Make sure that the sensor is in Switch mode.
2. Access the TEACH mode.

Action	Result
Single-pulse the remote input. 	"RMT TCH" and the current measurement value display.

3. Present the target.

Action	Result
Present the target.	"RMT TCH" and the target's measurement value display.

4. TEACH the sensor.

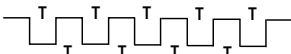
Action	Result
Five-pulse the remote input. 	"TchSPt Teaching" displays while the sensor is being taught. <u>TEACH Accepted</u> The new value displays on the second line of the display, flashes, and the sensor returns to Run mode. <u>TEACH Not Accepted</u> "FAIL" flashes, the sensor returns to step 3, and "RMT TCH" displays.

### 3.6.6 Adjust Switch Point

The AdjSPt option manually adjusts the value of the switch point threshold for the discrete output when the sensor is in Switch mode. The value is adjustable within the sensor's range. This menu is not available when the sensor is in Window, Alarm, or Health mode.

Navigate: MENU > D\_OUT > AdjSPt

Remote Input: Not available

Default: 50 mm

### 3.6.7 Mode





The Mode option sets the output to the desired mode.

Navigate: MENU > D\_OUT > Mode

Remote Input: Available

Default: Wnd  mode

The following table describes the sensor modes.

Mode	Description
Alarm	Alarm Mode: The Discrete Output is Off while a target is detected by the sensor at any distance. When a loss of signal occurs, the Discrete Output is On. This mode has no associated thresholds.
Health	Health Mode: The Discrete Output is On while a target is detected by the sensor at any distance. When a loss of signal occurs, the Discrete Output is Off. This mode has no associated thresholds.
Spt 	Switch Mode: The Discrete Output is On while a target is detected nearer than the switch point threshold. When a target is detected farther than the switch point threshold or the signal is lost, the Discrete Output is Off.
Spt 	Switch Mode: The Discrete Output is Off while a target is detected nearer than the switch point threshold. When a target is detected farther than the switch point threshold or the signal is lost, the Discrete Output is On.
Wnd 	Window Mode: The Discrete Output is On while a target is detected between the SPT1 and SPT2 thresholds. (Default) When a target is detected outside the SPT1 and SPT2 thresholds or the signal is lost, the Discrete Output is Off.
Wnd 	Window Mode: The Discrete Output is Off while a target is detected between the SPT1 and SPT2 thresholds. When a target is detected outside the SPT1 and SPT2 thresholds or the signal is lost, the Discrete Output is On.

### Remote Input Instructions

1. Access the setup mode.

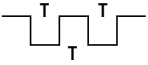



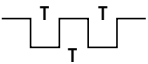





Action		Result
Double-pulse the remote input.		"REMOTE SETUP" displays.

2. View the current mode.

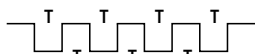
Action		Result
Double-pulse the remote input.		The current mode displays.

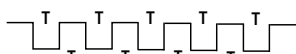
3. Program the sensor.



Action		Result
Pulse the remote input 1 to 6 times to select the desired mode.		The selected mode flashes and the sensor returns to Run mode.
Pulses	Mode	
1 	Alarm	
2 	Health	
3 	Swtch 	
4 	Swtch 	
5 	Wnd 	
6 	Wnd 	

### 3.6.8 Switch Point Reference (SPtRef)

The SPtRef menu only displays for a discrete output when it is set to switch mode. This setting cannot be changed with remote teach.

- Object (default). Object mode automatically optimizes the switching threshold just past the taught distance, farther away from the sensor's face.
- Background. Background mode automatically optimizes the switching threshold just in front of the taught distance, closer to the sensor's face.
- Custom. Custom mode allows the user to define the location of the switching threshold relative to a taught distance using the Offset menu that appears only after selecting Custom Switch Point Reference.

In Object or Background, the distance between the taught surface and the switching threshold varies depending on measurement stability. Use object mode when teaching an object if a change in state is required when the object is no longer present. Use background mode when teaching background so that the output state changes when a new object is in front of the background.

Navigate: MENU > D\_OUT > SPtRef

Remote Input: Not available

Default: Object

### 3.6.9 Switch Point TEACH Offset

Use this menu to set an offset from the taught distance after a switch point TEACH, if SPtRef is set to Custom.

By default, the value is 0 mm. A positive offset value always shifts the threshold towards the sensor.

### 3.6.10 Timer

The Timer option sets the delays and timers. On/Off Delays and On/Off One-Shot timers can be programmed between 1 to 9999 ms (a value of 0 disables the delay/timer). *Figure 16* on page 26 defines how the delays/timers affect the output behavior.

Navigate: MENU > D\_OUT > Timer

Remote Input: not available

Default: 0 ms for all timers

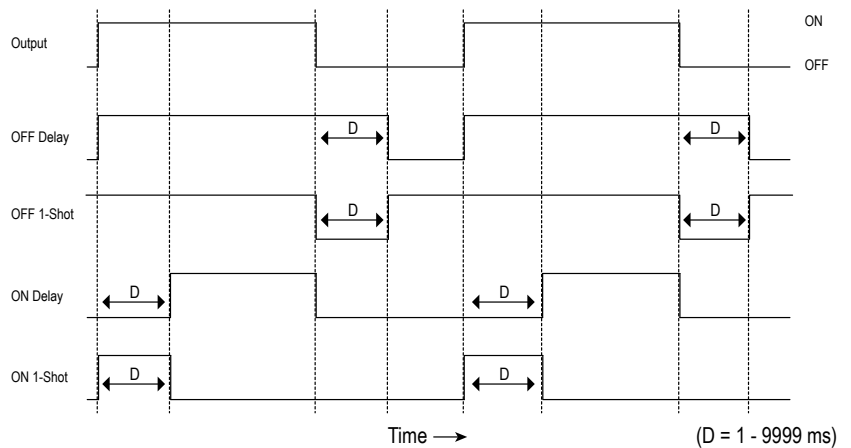

Figure 16. Delays/Timers

Some combinations of delays/timers are not allowed. The programming menu automatically disables invalid combinations of delays/timers. The following table shows the allowable combinations of delays/timers.

	Off Delay	Off One-Shot Timer	On Delay	On One-Shot Timer
Off Delay (OffDly)	OK	OK	OK	N/A
Off One-Shot Timer (Off1Sho)	OK	OK	N/A	N/A
On Delay (OnDly)	OK	N/A	OK	OK
On One-Shot Timer (On1Sho)	N/A	N/A	OK	OK

### 3.6.11 Polarity

The Polarity option sets the discrete output polarity to either PNP (current sourcing) or NPN (current sinking). The physical wiring of the sensor and the sensor polarity setting must match.

Navigate: MENU > D\_OUT > Polarity

Remote Input: Not available

Default: PNP

## 3.7 Input Menu (INPUT)

Use this menu to view or change the:

- Multi-function input type
- Active state of the remote input

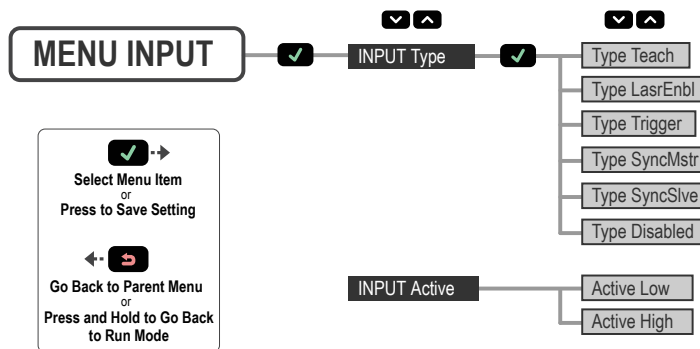

Figure 17. Input Menu Map

### 3.7.1 Input Type

The Type option sets the input type.

Navigate: MENU > INPUT > Type

Remote Input: Not available

Default: Disabled

Input Type	Description
Teach	The remote input is used to TEACH and program the sensor.
LasrEnbl	The remote input is used to control when the laser emitter is On/Off.
Trigger	The remote input is used to trigger advanced measurements To enable advanced measurements, the Input Type option must be set to Trigger (see <a href="#">Trigger</a> on page 28).
SyncMstr	The remote input is used as the Master Sync output to an attached Slave sensor (see <a href="#">Sync Master/Slave</a> on page 34).
SyncSlve	The remote input is used as the Slave Sync input from an attached Master sensor (see <a href="#">Sync Master/Slave</a> on page 34).
Disabled	The remote input is disabled. (Default)

### 3.7.2 Input Active

The Active option sets the active state of the remote input. Use the Active options to change the active input to Low or High.

Navigate: MENU > INPUT > Active

Remote Input: Not available

Default: Low

Input Active	Description
Low	The remote input detects low (0 V) inputs and high-to-low transitions. (Default)
High	The remote input detects high (V+) inputs and low-to-high transitions.

## 3.8 Measure Menu (MEASURE)

Use this menu to view or change the:

- Speed
- Trigger

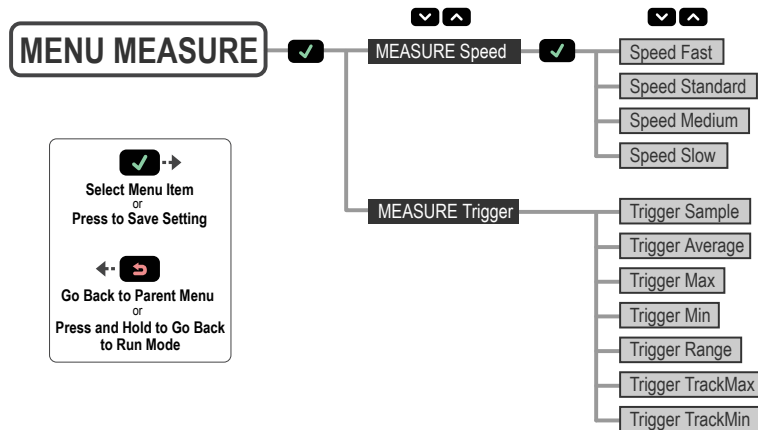

Figure 18. Measure Menu Map

### 3.8.1 Speed

The Speed option sets the speed at which the measurement is calculated. This process uses averaging in the digital processing of the signal to calculate the measurement. A slower speed increases the response time of the sensor but improves the repeatability. Refer to the repeatability specifications for each speed.

Navigate: MENU > MEASURE > Speed

Remote Input: Not available

Default: Medium

Speed	Response Time *	Lateral Entry
Fast	1.5 ms	5.5 ms
Standard	8 ms	16 ms
Medium	32 ms	48 ms
Slow	256 ms	288 ms

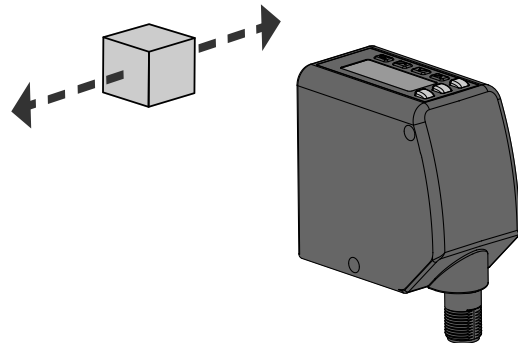

Figure 19. Lateral Entry Example

\* Response time triples when using Master/Slave mode.

### 3.8.2 Trigger

The Trigger option sets the advanced measurement that is calculated when a trigger event is detected on the remote input. The analog output updates with the new advanced measurement on each trigger event. To use these Trigger options, the sensor Input Type option must be set to Trigger; see [Input Type](#) on page 27.

Navigate: MENU > MEASURE > Trigger

Remote Input: Not available

Default: Sample

Trigger	Description
Sample	The current distance at the time of the trigger event. (Default) The Analog Output tracks the sample values during the measuring period.
Average	The averaged distance since the last trigger event.
Maximum (Max)	The maximum distance since the last trigger event.
Minimum (Min)	The minimum distance since the last trigger event.
Range	The difference between the maximum and minimum distance since the last trigger event. For additional information on the Range measurement behavior when the maximum or minimum distance is outside of the taught setpoints, see <a href="#">Loss of Signal</a> on page 17.
TrackMax	The maximum distance since the last trigger event. The Analog Output tracks new maximum values during the measurement period.
TrackMin	The minimum distance since the last trigger event. The Analog Output tracks new minimum values during the measurement period.

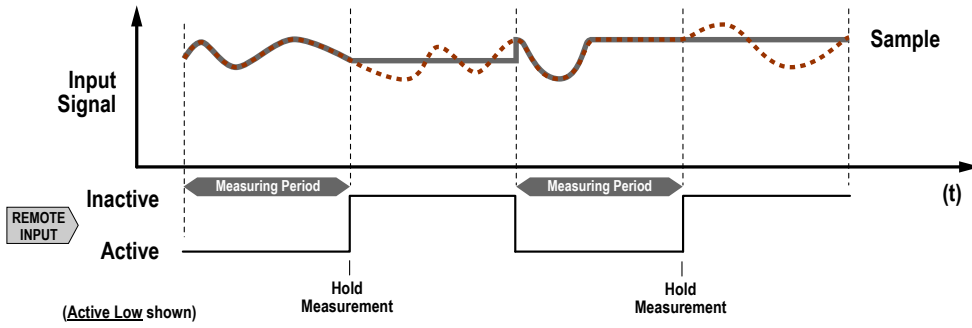

Figure 20. Sample

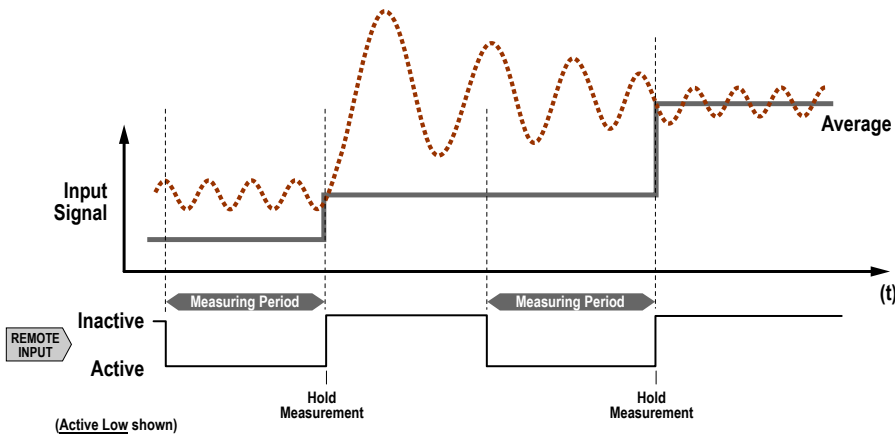

Figure 21. Average

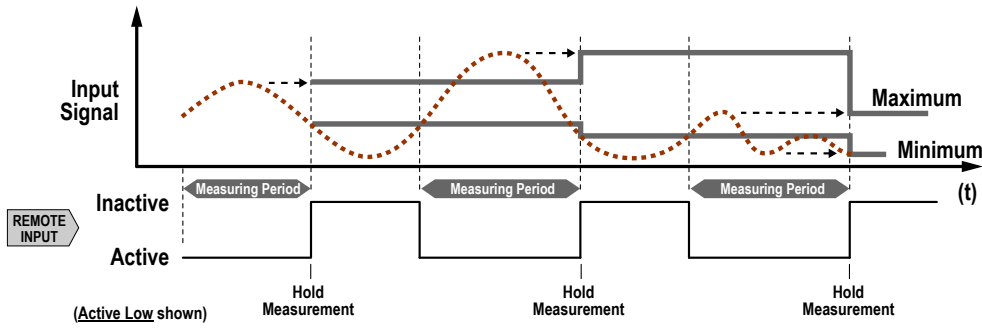

Figure 22. Maximum and Minimum

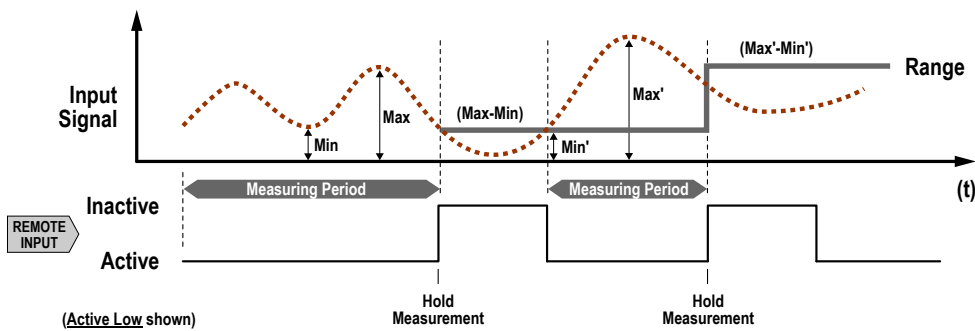

Figure 23. Range

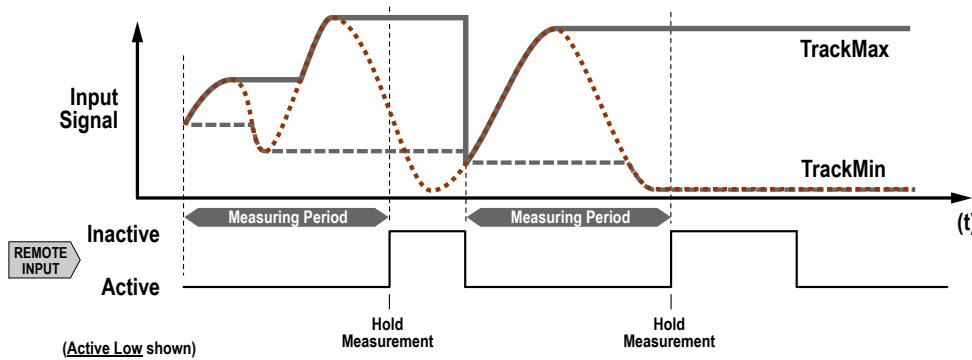

Figure 24. Track Maximum and Track Minimum

### 3.9 Display Menu (DISPLAY)

Use this menu to view or change the:

- Display units
- Display orientation
- Sleep mode settings

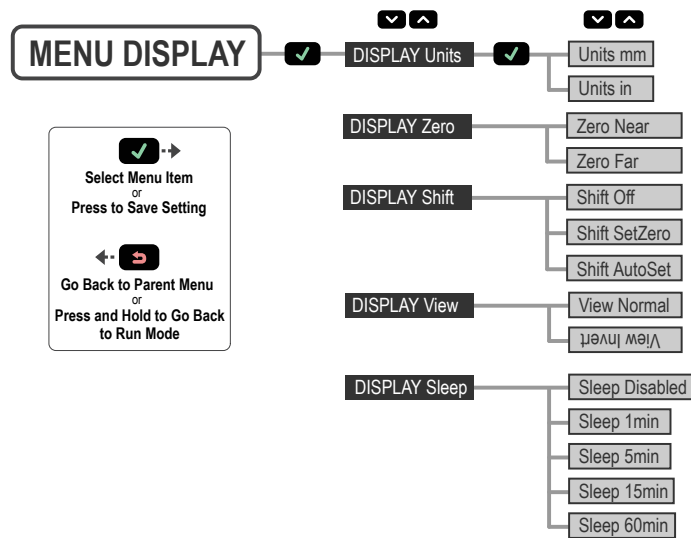

Figure 25. Display Menu Map

#### 3.9.1 Units

The Units option sets the displayed units to millimeters (mm) or inches (in).

Navigate: MENU > DISPLAY > Units

Remote Input: Not available

Default: mm

#### 3.9.2 Zero and Shift

Use the Display Zero menu to select the zero reference location. The default is , 0 = the face of the sensor.

- Near—0 = the face of the sensor; the measurement increases further from the sensor
- Far—0 = maximum range; the measurement increases closer to the sensor

Use the Display Shift menu to select whether the sensor shifts the zero reference location based on the last TEACH process. The default is Off (0).

- Off—0 = the face of the sensor or the maximum range, depending on the zero setting
- SetZero—Sets the current distance as its new zero reference location. This process is independent of teaching analog or discrete set points.
- AutoSet—Shifts the zero reference location at the taught distance during any analog or discrete setting teach.

This figure illustrates three examples of how changes to the zero and shift settings affect what distance readout is shown on the display when in 2-pt TEACH mode. Changes to the zero setting affect the direction in which the distance increases. Turning the shift setting on sets the taught location as the reference point for any distance measurement.

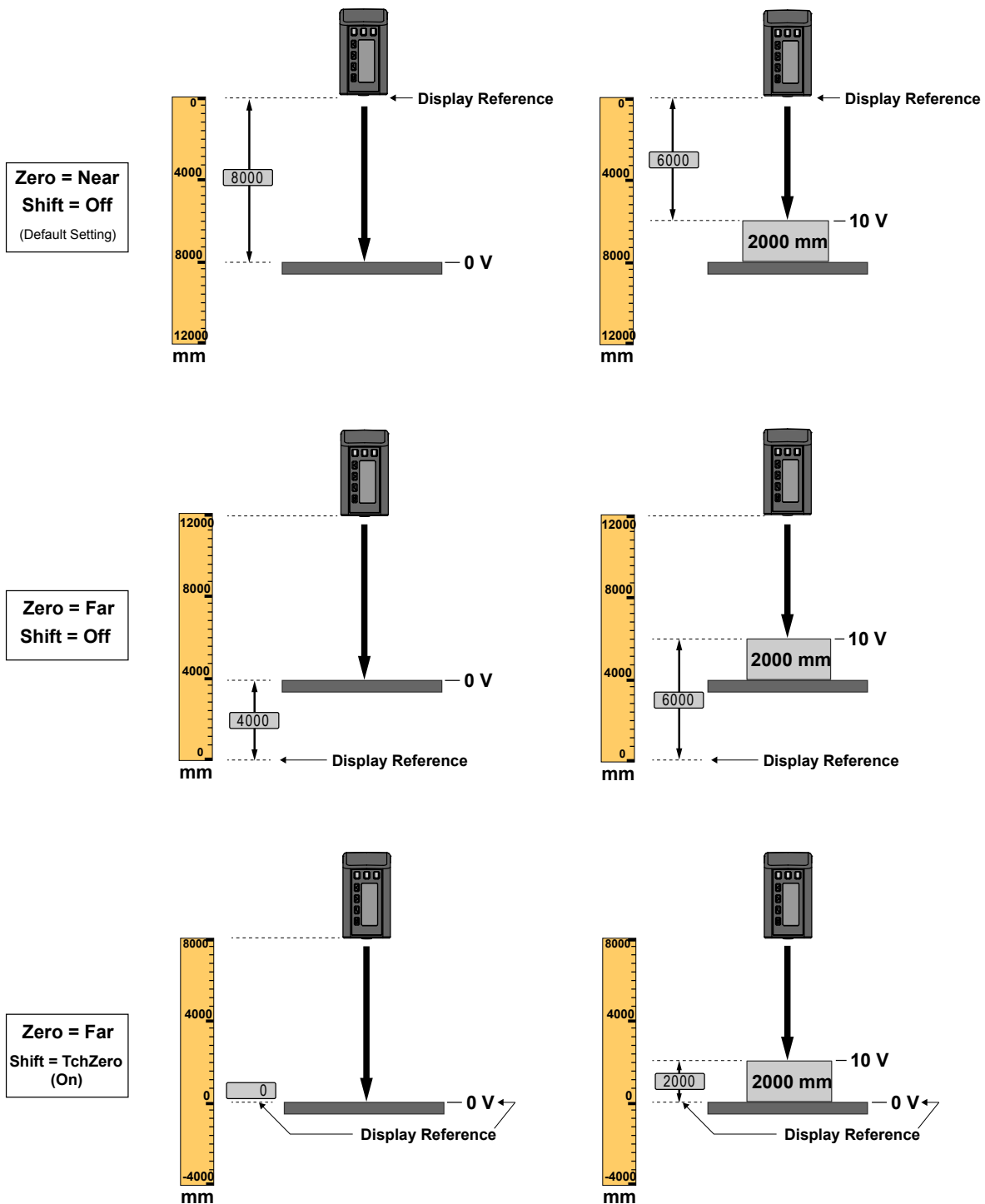

Figure 26. Example Zero and Shift settings

### 3.9.3 View

The View option sets the display orientation of the sensor. For applications where the sensor must be mounted so that the display is not right-reading, invert the display for readability. The Down and Up buttons do not change when the display is inverted.

Navigate: MENU > DISPLAY > View

Remote Input: Not available

Default: Normal



Figure 27. Normal Display Orientation



Figure 28. Inverted Display Orientation

### 3.9.4 Sleep

The Sleep option sets when the display is put to sleep. Four timing options are available: 1, 5, 15, or 60 minutes. Sleep mode is disabled by default. Sleep occurs in Run mode and any menu. To wake the sensor and return to the last viewed mode or menu, press any button.

Navigate: MENU > DISPLAY > Sleep

Remote Input: Not available

Default: Disabled

## 3.10 Information Menu (INFO)

Use this menu to view model, part number (P/N), serial number (S/N), and firmware version (Version) information. Select one of these options to view specific information for your sensor. This information is read-only.

Navigate: MENU > INFO

Remote Input: Not available

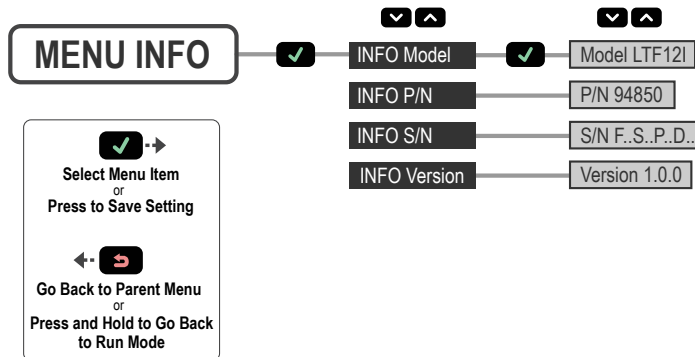

Figure 29. Information Menu Map



### 3.11 Reset Menu (RESET)

Use this menu to restore the sensor to the factory default settings.

Navigate: MENU > RESET. Select Yes to apply the factory defaults; select No to return to the Reset option without changing any sensor settings.

Remote Input: Eight-pulse the remote input

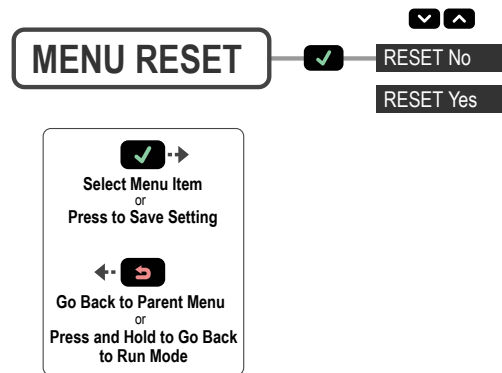
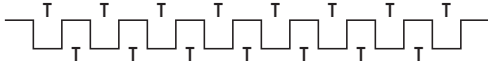

Figure 30. Reset Menu Map

#### 3.11.1 Factory Default Settings

Analog Output Settings	Value
Adjust 4 mA (0 V)	50 mm
Adjust 4 mA (10 V)	12000 mm
Loss of Signal	3.5 mA (0 V)
Slope	Positive
Window Size	2000 mm

Discrete Output Settings	Value
Adjust Switch Point One	50 mm
Adjust Switch Point Two	12000 mm
Mode	Wnd
Polarity	PNP
Timer	0 ms for all timers
Window Size	20 mm

Input Settings	Value
Input Active	Low
Input Type	Disabled

Measure Settings	Value
Speed	Medium
Trigger	Sample

Display Settings	Value
Sleep	Disabled
Units	mm
Zero	Near
Shift	Off
View	Normal

## 4 Sync Master/Slave

Two LTF sensors may be used together in a single sensing application. To eliminate crosstalk between the two sensors, configure one sensor to be the master and one to be the slave. In this mode, the sensors alternate taking measurements and the response speed triples.

1. Configure the first sensor as the master; navigate: MENU > INPUT > Type > SyncMstr.
2. Configure the second sensor as the slave; navigate: MENU > INPUT > Type > SyncSlve.
3. Connect the gray (input) wires of the two sensors together.

## 5 Additional Remote TEACH Procedures

### 5.1 TEACH Analog Output and Discrete Output Switch Points Together

Use the following procedure to teach identical Analog Output and Discrete Output switch points at the same time using the remote input. This feature is not available using the buttons.

1. Access the TEACH mode.

Action		Result
Single-pulse the remote input.		"RMT TCH" and the current measurement value display.

2. Present the target.

Action		Result
Present the switch point one target.		"RMT TCH" and the target's measurement value display.

3. TEACH the sensor.

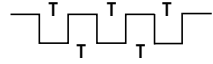
Action		Result
Three-pulse the remote input.		"TchA&D1 Teaching" displays while the sensor is being taught. <u>TEACH Accepted</u> The new value displays on the second line of the display, flashes, and then "TchA&D2" and the current measurement value display. <u>TEACH Not Accepted</u> "FAIL" flashes, the sensor returns to step 2, and "RMT TCH" displays.

4. Present the target.

Action		Result
Present the switch point two target.		"TchA&D2" and the target's measurement value display.

5. TEACH the sensor.

Action		Result
Single-pulse the remote input.		"TchA&D2 Teaching" displays while the sensor is being taught. <u>TEACH Accepted</u> The new value displays on the second line of the display, flashes, and the sensor returns to Run mode. <u>TEACH Not Accepted</u> "FAIL" flashes, the sensor returns to step 2, and "RMT TCH" displays.

### 5.2 TEACH Analog Output and Discrete Output Midpoints Together

Use the following procedure to teach an identical Analog Output 12 mA (5 V) point and Discrete Output midpoint (switch point) at the same time using the remote input. This feature is not available using the buttons. Note that if the window sizes and/or offsets were set independently (using the buttons), the windows taught using the following procedure could be different.

When the Discrete Output is set to Switch Mode, the SPT TEACH is executed with SPTRef=Custom and Offset=0 mm.

1. Access the TEACH mode.

Action		Result
Single-pulse the remote input.		"RMT TCH" and the current measurement value display.

2. Present the target.

Action		Result
Present the midpoint (switch point) target.		"RMT TCH" and the target's measurement value display.

3. TEACH the sensor.

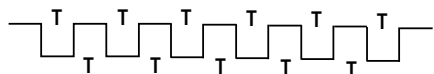
Action		Result
Six-pulse the remote input.		<p>"TchA&amp;D Teaching" displays while the sensor is being taught.</p> <p><u>TEACH Accepted</u></p> <p>The new value displays on the second line of the display, flashes, and the sensor returns to Run mode.</p> <p><u>TEACH Not Accepted</u></p> <p>"FAIL" flashes, the sensor returns to step 2, and "RMT TCH" displays.</p>

# 6 Specifications

**Supply Voltage**  
12 to 30 V dc

**Power and Current Consumption (Exclusive of Load)**  
Normal Run Mode: < 2.1 W  
Current consumption < 85 mA at 24 V dc

**Supply Protection Circuitry**  
Protected against reverse polarity and transient overvoltages

**Output Configuration**  
Analog output: 4 to 20 mA or 0 to 10 V, depending on model  
Discrete output rating: Discrete NPN/PNP is user-configurable

**Output Ratings**  
Discrete Output: 100 mA maximum (protected against continuous overload and short circuit)  
OFF-state leakage current (PNP): < 10 µA at 30 V  
OFF-state leakage current (NPN): < 200 µA at 30 V  
Output saturation voltage (PNP outputs): < 3 V at 100 mA  
Output saturation voltage (NPN outputs): < 1.6 V at 100 mA  
Analog current output (LTF...I Models): 1 kΩ maximum at 24 V; maximum load resistance = [(Vcc-4.5)/0.02 Ω]  
Analog voltage output (LTF...U Models): 2.5 kΩ minimum load resistance

**Remote Input**  
Allowable Input Voltage Range: 0 to Vcc  
Active Low (internal weak pullup—sinking current):  
High State > 4.3 V at 740 µA maximum  
Low State < 1.3 V at 800 µA maximum  
Active High (internal weak pulldown—sourcing current):  
High State > 4.3 V at 1.7 mA maximum  
Low State < 1.3 V at 1.6 mA maximum

**Response Time**  
Fast: 1.5 ms  
Standard: 8 ms  
Medium: 32 ms  
Slow: 256 ms

**Storage Conditions**  
-30 °C to +65 °C (-22 °F to +149 °F)

**Operating Conditions**  
-20 °C to +55 °C (-4 °F to +131°F)  
90% at +55 °C maximum relative humidity (non-condensing)

**Environmental Rating**  
IEC IP67; NEMA 6

**Vibration and Mechanical Shock**  
All models meet Mil. Std. 202G requirements method 201A. Also meets 60947-5-2.

**Application Note**  
For optimum performance, allow 15 minutes for the sensor to warm up

**Certifications**



**Sensing Beam**  
Visible red, 660 nm

**Sensing Range**  
90% White Target: 50 mm (1.97 in) to 12000 mm (472.44 in)  
18% Gray Target: 50 mm (1.97 in) to 11000 mm (433 in)  
6% Black Target: 50 mm (1.97 in) to 7000 mm (275.5 in)

**Construction**  
Die-cast zinc housing; acrylic window

**Maximum Torque**  
2.6 N·m (23.0 in-lbs)

**Ambient Light Immunity**  
> 40000 lux

**Delay at Power Up**  
2 seconds

**Measurement Output Rate**  
0.5 ms

**Minimum Window Size, Analog and Discrete**  
10 mm

**Boresighting**  
40 mm radius at 12000 mm

**Temperature Effect**  
±0.25 mm/°C (typical)

**Linearity/Accuracy**

Reflectance	±10 mm	±20 mm
6% Black Card	5 m	7 m
18% Gray Card	8 m	11 m
90% White Card	12 m	-

**Repeatability**  
See Performance Curves

**Resolution**  
< 0.3 to 3 mm<sup>1</sup>

**Beam Spot Size**  
6.5 mm at 50 mm  
10 mm at 7500 mm  
12.5 mm at 12000 mm  
Beam spot size is calculated as 1.6 times the D4σ measured value

**Required Overcurrent Protection**



**WARNING:** Electrical connections must be made by qualified personnel in accordance with local and national electrical codes and regulations.

Overcurrent protection is required to be provided by end product application per the supplied table. Overcurrent protection may be provided with external fusing or via Current Limiting, Class 2 Power Supply. Supply wiring leads < 24 AWG shall not be spliced. For additional product support, go to <http://www.bannerengineering.com>.

Supply Wiring (AWG)	Required Overcurrent Protection (Amps)
20	5.0
22	3.0
24	2.0
26	1.0
28	0.8
30	0.5

<sup>1</sup> Resolution measured as twice repeatability with white target at slow response speed at 20 °C. See repeatability curves for more detail.

## 6.1 Repeatability Performance

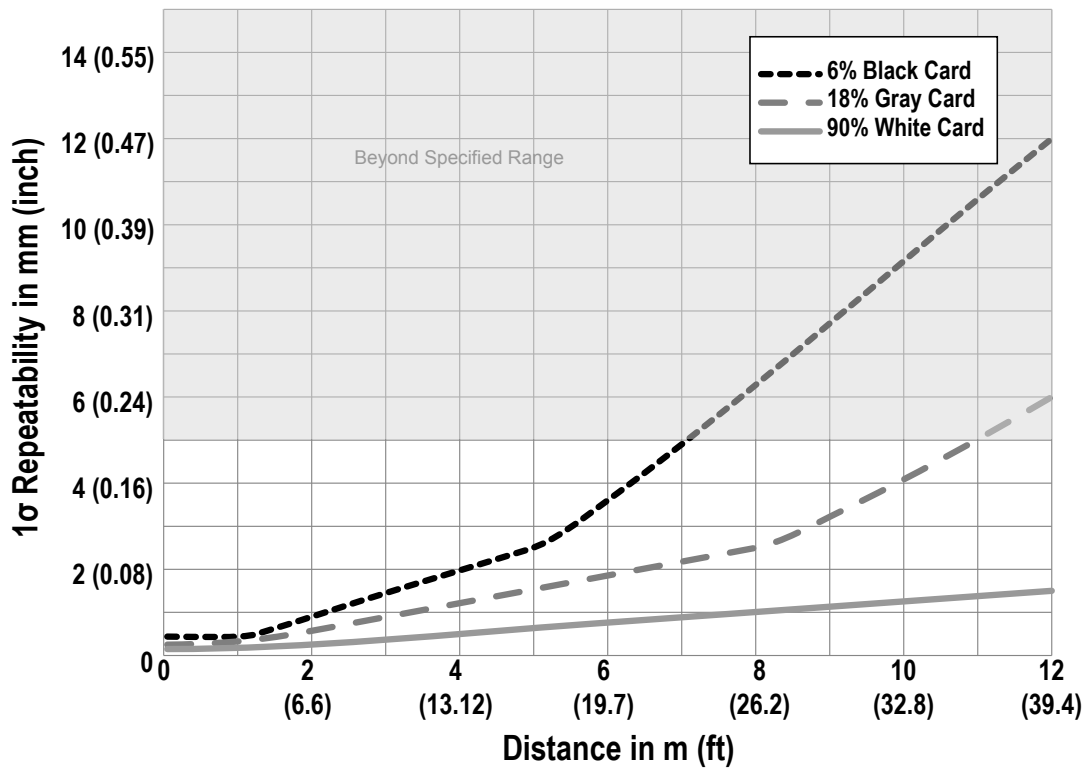

Figure 31. Speed: Slow (256 ms)

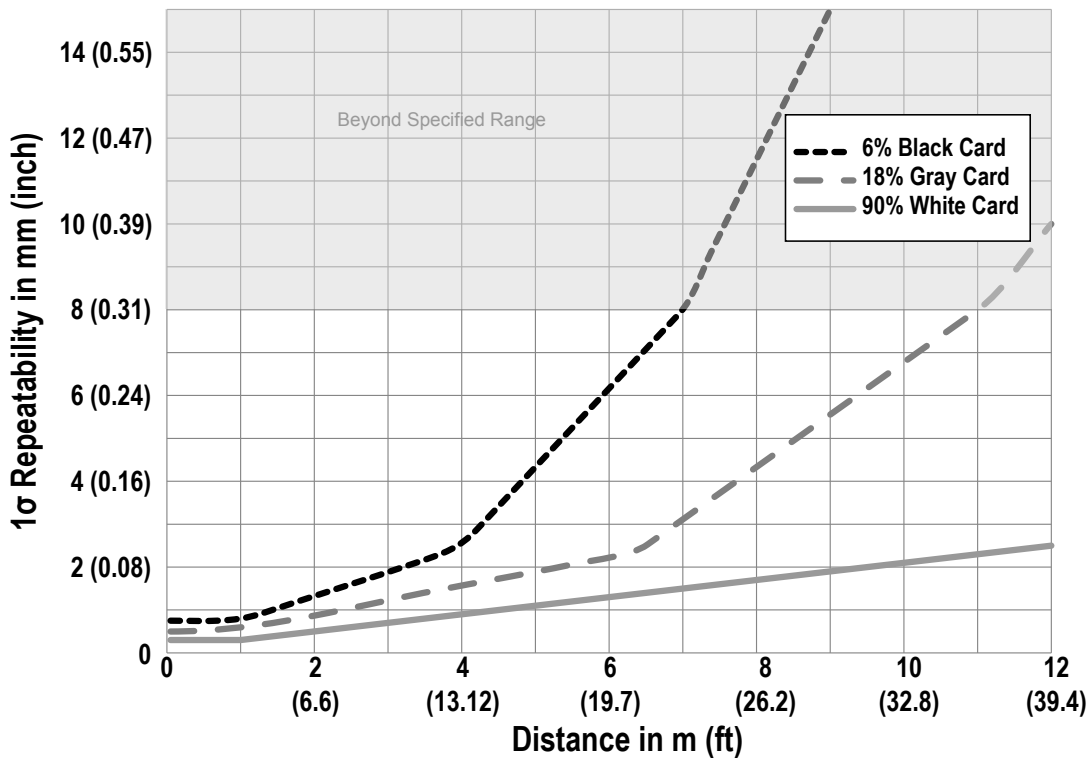

Figure 32. Speed: Medium (32 ms)

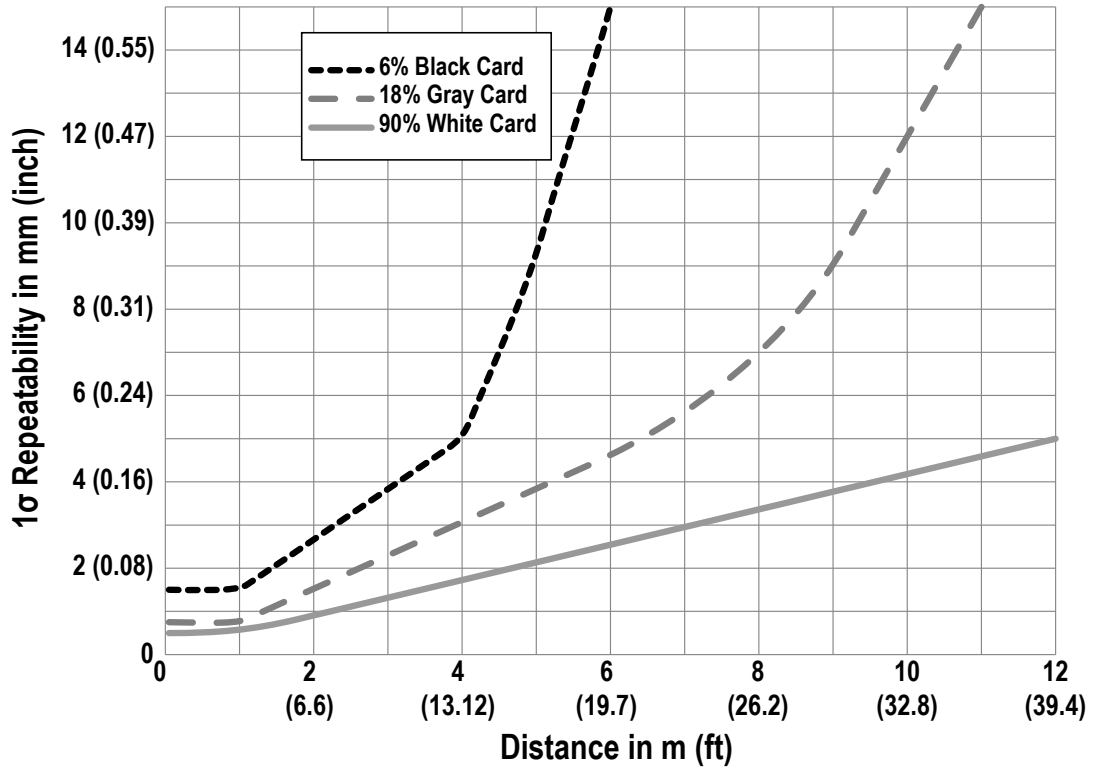

Figure 33. Speed: Standard (8 ms)

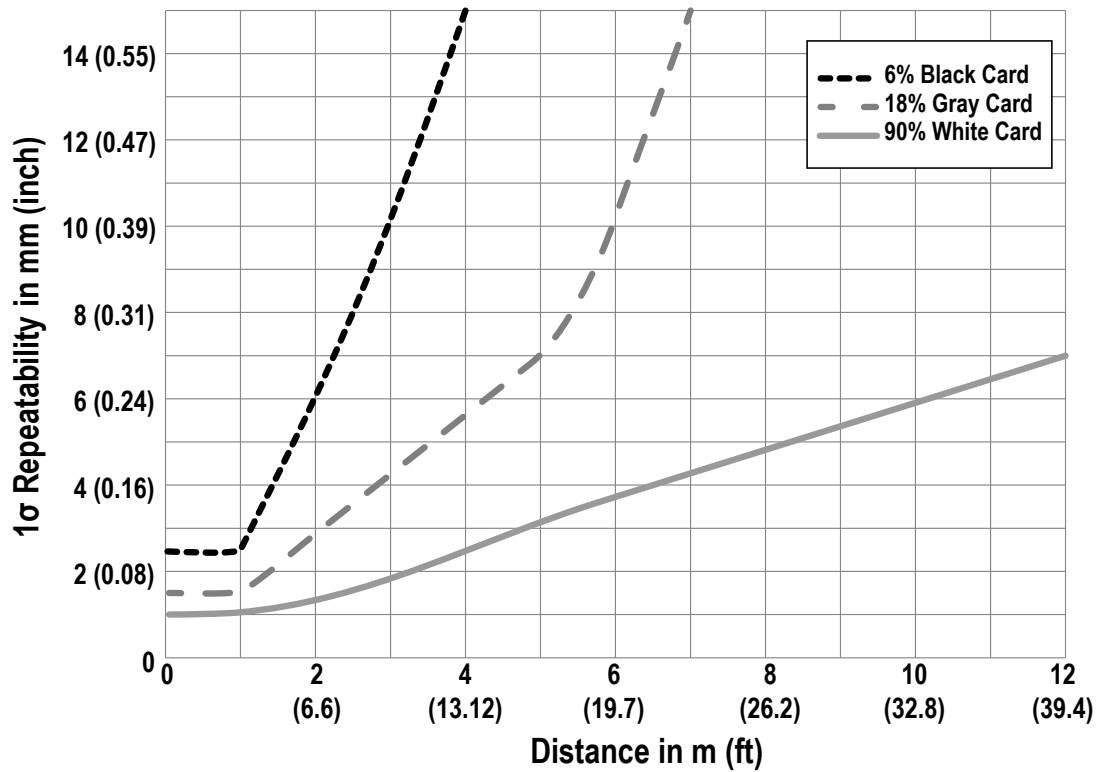
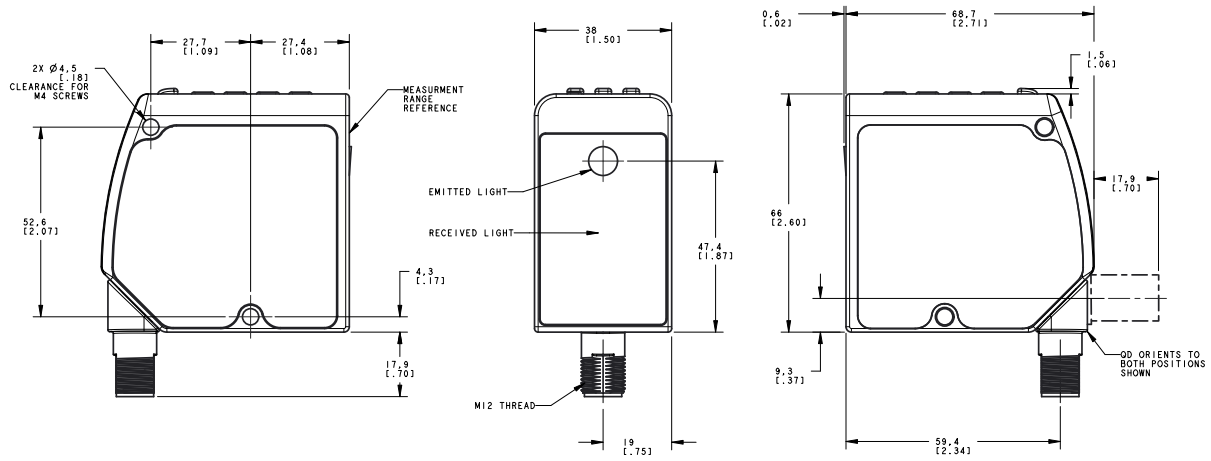

Figure 34. Speed: Fast (1.5 ms)

\* 1 Sigma repeatability

## 6.2 Dimensions



All measurements are listed in millimeters [inches], unless noted otherwise.



## 7 Troubleshooting

Message/Indicator	Description	Resolution
Fail/ Out of Range	The TEACH failed, the target is out of range. The target might have moved out of range after the TEACH process began.	TEACH the target within the measurement range.
Fail/ OfSt Out of Range	The TEACH failed. The target is in range but the offset value caused the setpoint(s) to be out of range.	Adjust the offset value or target distance to keep the setpoint(s) within the measurement range.
MIN Wnd xx mm (xx in)	The adjusted or taught window size is too small; the minimum window size is displayed.	The sensor automatically adjusts the window size to maintain the minimum window size and completes the adjust or TEACH operation.
xxxx < NEAR	The threshold (xxxx) is less than the minimum sensing range. xxxx could be 4mA Pt (0V Pt), 20mA Pt (10V Pt) or SPt1.	The desired window size is maintained, but the usable portion of the window is restricted to be within the defined sensing range.
xxxx > FAR	The threshold (xxxx) is greater than the maximum sensing range. xxxx could be 4mA Pt (0V Pt), 20mA Pt (10V Pt) or SPt2.	The desired window size is maintained, but the usable portion of the window is restricted to be within the defined sensing range.
OutRnge	The target is out of range, too dark, or the sensor is not measuring.	Move the target within the measurement range.
< NEAR	During RUN mode the target is detected, but is inside the NEAR measuring range.	The sensor can reliably detect targets up to the face of the sensor, and the Discrete Output state is valid. The Analog Output cannot be used to measure distances inside the NEAR measuring range.
Power LED is flashing green	The sensor input is set to laser enable and the input is not active.	See <a href="#">Input Type</a> on page 27.
All LEDs are flashing	The laser shuts off, the Power LED flashes green, the Output LEDs flash amber at 1 Hz, and the display is blank.  The sensor has experienced a fault.	Contact Banner Engineering to resolve.
Type Sync Slave	The slave mode sensor does not see the master's pulse.	Make sure that the master mode sensor is configured and functioning properly. Check the input wire connection between the master and slave.

# 8 Sensor Menu Full Map

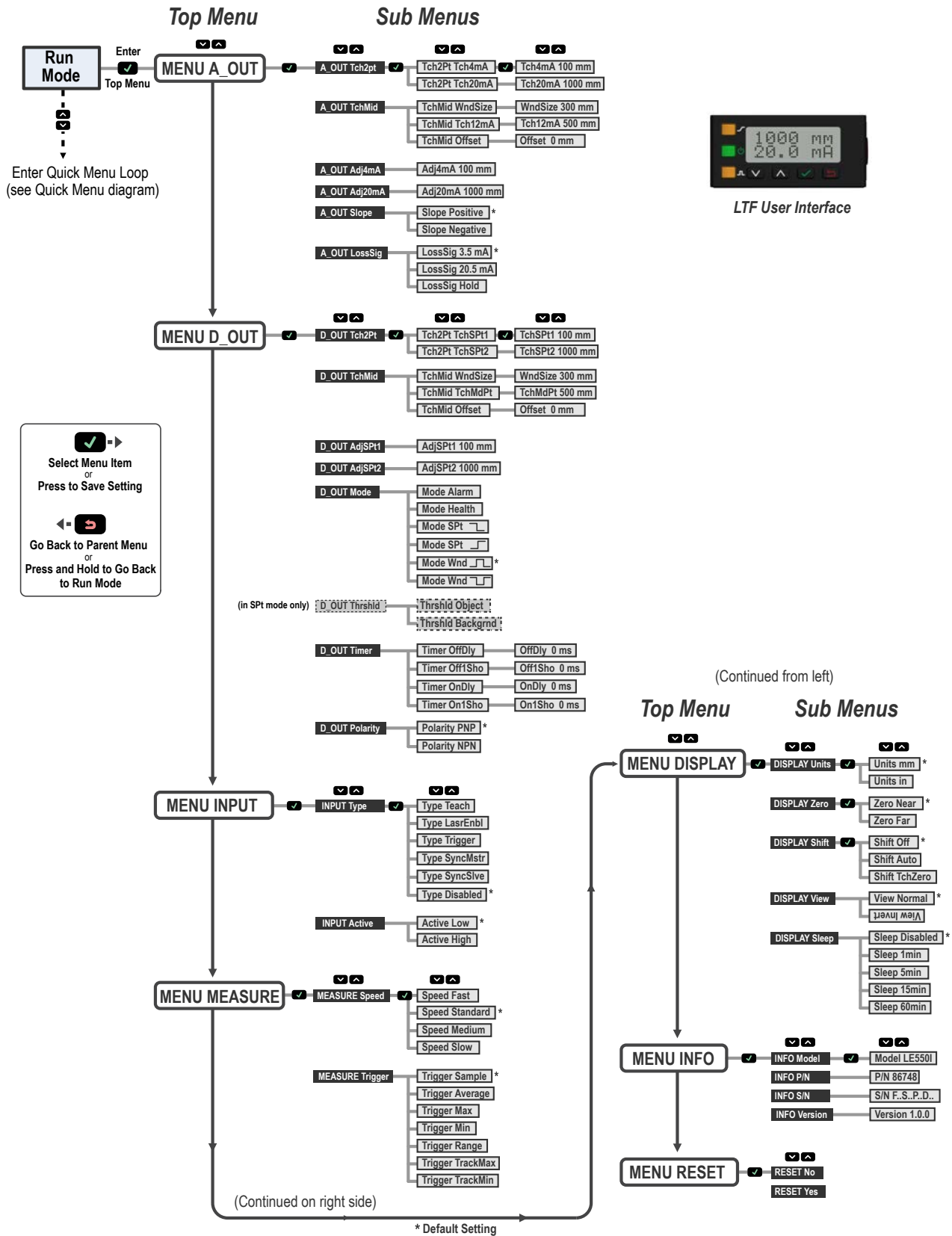

## 9 Accessories

### 9.1 Cordsets

All measurements are listed in millimeters, unless noted otherwise.

5-Pin Threaded M12/Euro-Style Cordsets—with Shield				
Model	Length	Style	Dimensions	Pinout (Female)
MQDEC2-506	1.83 m (6 ft)	Straight		
MQDEC2-515	4.57 m (15 ft)			
MQDEC2-530	9.14 m (30 ft)			
MQDEC2-550	15.2 m (50 ft)			
MQDEC2-506RA	1.83 m (6 ft)	Right-Angle		
MQDEC2-515RA	4.57 m (15 ft)			
MQDEC2-530RA	9.14 m (30 ft)			
MQDEC2-550RA	15.2 m (50 ft)			

### 9.2 Brackets

All measurements are listed in millimeters, unless noted otherwise.

#### SMBLTFFA

- Swivel plate bracket
- 5 mm stainless steel

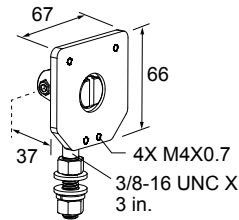

#### SMBLTFL

- Right-angle bracket
- 12 gauge stainless steel

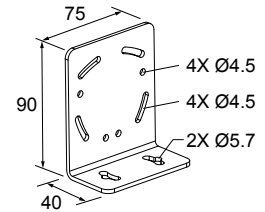

#### SMBLTFU

- Enclosed bracket
- 16 gauge stainless steel

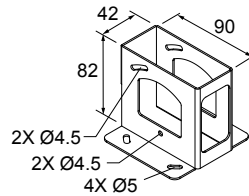

#### SMBAMSLTFP

- AMS mounting pattern
- 12 gauge stainless steel

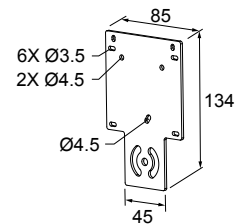

## 10 Banner Engineering Corp. Limited Warranty

Banner Engineering Corp. warrants its products to be free from defects in material and workmanship for one year following the date of shipment. Banner Engineering Corp. will repair or replace, free of charge, any product of its manufacture which, at the time it is returned to the factory, is found to have been defective during the warranty period. This warranty does not cover damage or liability for misuse, abuse, or the improper application or installation of the Banner product.

THIS LIMITED WARRANTY IS EXCLUSIVE AND IN LIEU OF ALL OTHER WARRANTIES WHETHER EXPRESS OR IMPLIED (INCLUDING, WITHOUT LIMITATION, ANY WARRANTY OF MERCHANTABILITY OR FITNESS FOR A PARTICULAR PURPOSE), AND WHETHER ARISING UNDER COURSE OF PERFORMANCE, COURSE OF DEALING OR TRADE USAGE.

This Warranty is exclusive and limited to repair or, at the discretion of Banner Engineering Corp., replacement. IN NO EVENT SHALL BANNER ENGINEERING CORP. BE LIABLE TO BUYER OR ANY OTHER PERSON OR ENTITY FOR ANY EXTRA COSTS, EXPENSES, LOSSES, LOSS OF PROFITS, OR ANY INCIDENTAL, CONSEQUENTIAL OR SPECIAL DAMAGES RESULTING FROM ANY PRODUCT DEFECT OR FROM THE USE OR INABILITY TO USE THE PRODUCT, WHETHER ARISING IN CONTRACT OR WARRANTY, STATUTE, TORT, STRICT LIABILITY, NEGLIGENCE, OR OTHERWISE.

Banner Engineering Corp. reserves the right to change, modify or improve the design of the product without assuming any obligations or liabilities relating to any product previously manufactured by Banner Engineering Corp. Any misuse, abuse, or improper application or installation of this product or use of the product for personal protection applications when the product is identified as not intended for such purposes will void the product warranty. Any modifications to this product without prior express approval by Banner Engineering Corp will void the product warranties. All specifications published in this document are subject to change; Banner reserves the right to modify product specifications or update documentation at any time. Specifications and product information in English supersede that which is provided in any other language. For the most recent version of any documentation, refer to: [www.bannerengineering.com](http://www.bannerengineering.com).