

**LSRL 8**

**Throughbeam photoelectric laser sensors**

en 06-2014/07 50126807



**100m**

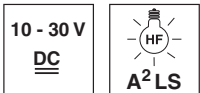

- Red light laser in laser class 2
- A²LS - Active Ambient Light Suppression
- Adjustable focus
- M12 turning connector or cable connection
- Activation input

**Dimensioned drawing**

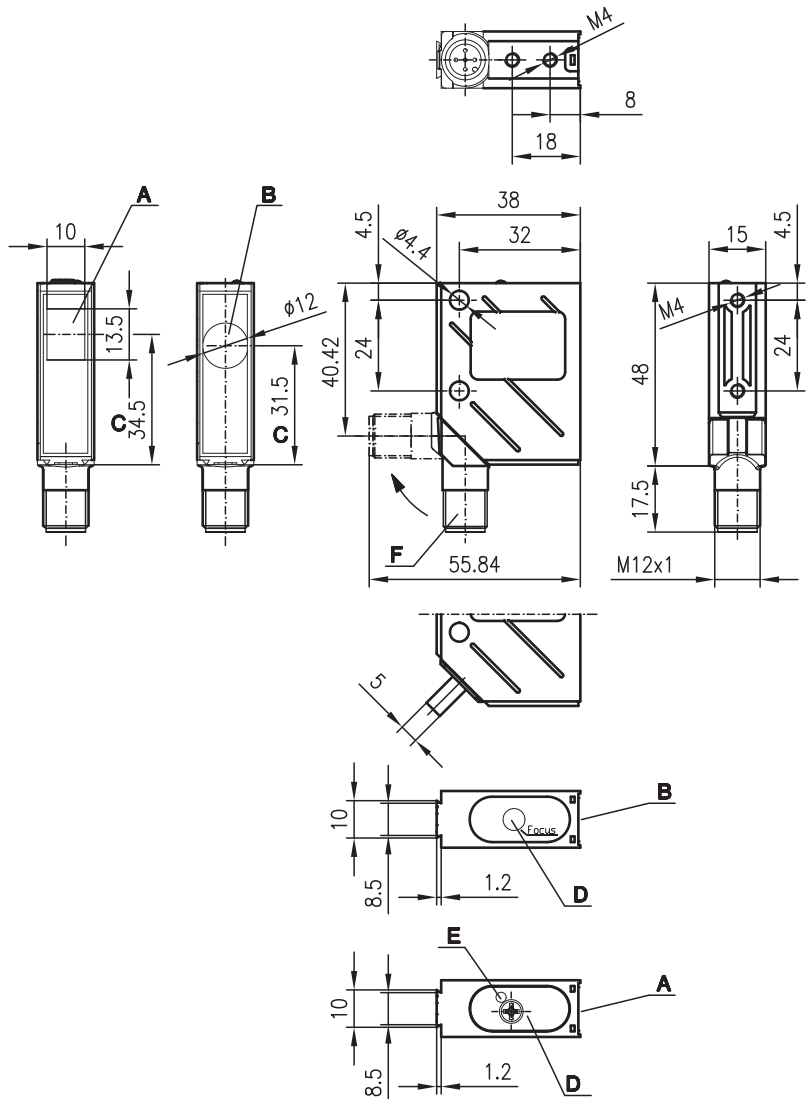

- A** Receiver
- B** Transmitter
- C** Optical axis
- D** Operational control
- E** Yellow LED
- F** Turning connector, 90° rot. angle

**Electrical connection**

LSRL 8/24.01  
LSRL 8/24.01-S12

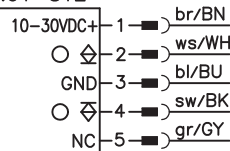

LSSRL 8.9  
LSSRL 8.9-S12

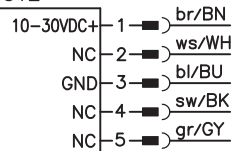

LSRL 8/44.01-S12

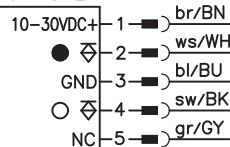

LSSRL 8.98-S12

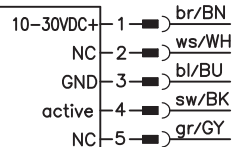

We reserve the right to make changes • DS\_LSRL8\_en\_50126807.fm



**Accessories:**

(available separately)

- M12 connectors (KD ...)
- Ready-made cables (K-D ...)
- Mounting systems
- Diaphragms
- Control guard

**Specifications**

**Optical data**

Typ. operating range limit <sup>1)</sup>	100m
Operating range <sup>2)</sup>	60m
Light spot diameter	≥ 0.1mm adjustable (see diagrams)
Focus adjustment range	140mm ... ∞ (see diagrams)
Beam divergence	≥ 0.5mrad
Light source	laser
Wavelength	670nm (visible red light, polarized)

**Timing**

Switching frequency	2800Hz
Response time	0.18ms
Delay before start-up	≤ 100ms

**Electrical data**

Operating voltage $U_B$ <sup>3)</sup>	10 ... 30VDC
Residual ripple	≤ 15% of $U_B$
Open-circuit current	≤ 35mA
Switching output	.../24... 1 PNP and 1 NPN transistor output, light switching
	.../44... 2 PNP transistor outputs, antivalent
Signal voltage high/low	≥ ( $U_B - 2V$ ) / ≤ 2V
Output current	max. 100mA
Sensitivity	adjustable with 270° potentiometer

**Indicators**

Yellow LED, receiver	light path free
Yellow LED flashing, receiver	light path free, no performance reserve

**Mechanical data**

Housing	metal
Optics cover	glass
Weight (plug/cable)	70g/140g
Connection type	M12 connector, 5-pin, turning or cable: 2000mm, 5x0.25mm <sup>2</sup>

**Environmental data**

Ambient temp. (operation/storage)	-10°C ... +40°C / -40°C ... +70°C
Protective circuit <sup>4)</sup>	2, 3
VDE safety class <sup>5)</sup>	II, all-insulated
Degree of protection <sup>6)</sup>	IP 67, IP 69K <sup>7)</sup>
Laser class	2 (in accordance with EN 60825-1)
Standards applied	IEC 60947-5-2
Certifications	UL 508, C22.2 No.14-13 <sup>3)</sup> <sup>8)</sup>

**Options**

<b>Activation input active</b>	
Transmitter active/not active	$U_B$ /0V or not connected

- 1) Typ. operating range limit: max. attainable range without performance reserve with focus set to ∞
- 2) Operating range: recommended range with performance reserve with focus set to 2m
- 3) For UL applications: for use in class 2 circuits according to NEC only
- 4) 2=polarity reversal protection, 3=short circuit protection for all outputs
- 5) Rating voltage 250VAC
- 6) In end position of the turning connector (turning connector engaged)
- 7) IP 69K test acc. to DIN 40050 part 9 simulated, high pressure cleaning conditions without the use of additives, acids and bases are not part of the test
- 8) These proximity switches shall be used with UL Listed Cable assemblies rated 30V, 0.5A min, in the field installation, or equivalent (categories: CYJV/CYJV7 or PVVA/PVVA7)

**Tables**

without diaphragm:

0	60	100
---	----	-----

with pin diaphragm in front of receiver <sup>1)</sup>:

0	8	10
---	---	----

with slit diaphragm in front of receiver <sup>1)</sup>:

0	16	20
---	----	----

□ Operating range [m] \*  
 ■ Typ. operating range limit [m] \*\*

\* for focus adjusted to 2m  
 \*\* for focus adjusted to ∞

1) Smallest object over the entire operating range with pin diaphragm: Ø=0.7mm, slit diaphragm: Ø=1.0mm

**Diagrams**

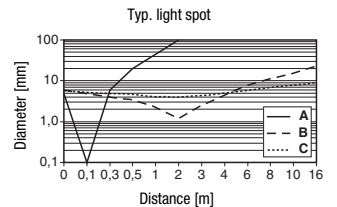

- A Focus set to 0.125m
- B Focus set to 2m
- C Focus set to 16m

**Order guide**

	<b>Designation</b>	<b>Part no.</b>
<b>With M12 connector</b>		
Transmitter and receiver	LSRL 8/24.91-S12	
Transmitter	LSSRL 8.9-S12	50036358
Receiver	LSERL 8/24.01-S12	50036359
<b>With M12 connector</b>		
Transmitter and receiver	LSRL 8/44.98-S12	
Transmitter	LSSRL 8.98-S12	50126800
Receiver	LSERL 8/44.01-S12	50126801
<b>With 2m cable</b>		
Transmitter and receiver	LSRL 8/24.91	
Transmitter	LSSRL 8.9	50037083
Receiver	LSERL 8/24.01	50037084

**Remarks**

**Operate in accordance with intended use!**

- ⚠ This product is not a safety sensor and is not intended as personnel protection.
- ⚠ The product may only be put into operation by competent persons.
- ⚠ Only use the product in accordance with the intended use.

**Laser safety notices**

**⚠ ATTENTION, LASER RADIATION – LASER CLASS 2**

**Never look directly into the beam!**

The device fulfills the EN 60825-1:2008-05 (IEC 60825-1:2007) safety regulations for a product in **laser class 2** as well as the U.S. 21 CFR 1040.10 regulations with deviations corresponding to "Laser Notice No. 50" from June 24th, 2007.

- ↳ Never look directly into the laser beam or in the direction of reflecting laser beams!  
If you look into the beam path over a longer time period, there is a risk of injury to the retina.
- ↳ Do not point the laser beam of the device at persons!
- ↳ Intercept the laser beam with an opaque, non-reflective object if the laser beam is accidentally directed towards a person.
- ↳ When mounting and aligning the device, avoid reflections of the laser beam off reflective surfaces!
- ↳ **CAUTION!** Use of controls or adjustments or performance of procedures other than specified herein may result in hazardous light exposure.  
The use of optical instruments or devices (e.g., magnifying glasses, binoculars) with the product will increase eye hazard.
- ↳ Adhere to the applicable legal and local regulations regarding protection from laser beams acc. to EN 60825 (IEC 60825) in its latest version.
- ↳ The device must not be tampered with and must not be changed in any way.  
There are no user-serviceable parts inside the device.  
Repairs must only be performed by Leuze electronic GmbH + Co. KG.

**NOTICE**

**Affix laser information and warning signs!**

Laser information and warning signs are affixed to the device (see ①). In addition, self-adhesive laser information and warning signs (stick-on labels) are supplied in several languages (see ②).

- ↳ Affix the laser information sheet with the language appropriate for the place of use to the device.  
When using the device in the US, use the stick-on label with the "Complies with 21 CFR 1040.10" notice.
- ↳ Affix the laser information and warning signs near the device if no signs are attached to the device (e.g. because the device is too small) or if the attached laser information and warning signs are concealed due to the installation position.  
Affix the laser information and warning signs so that they are legible without exposing the reader to the laser radiation of the device or other optical radiation.

①



**A** Laser exit opening  
**B** Laser warning sign

②

**50107525-02**

<p style="text-align: center; font-size: small;">LASERSTRAHLUNG NIGHT IN DEN STRAHL BLICKEN</p> <p style="font-size: x-small;">Max. Leistung (peak): 3 mW Impulsdauer: 8 µs Wellenlänge: 670 nm</p> <p style="text-align: center; font-size: x-small;">LASER KLASSE 2 DIN EN 60825-1:2008-05</p>	<p style="text-align: center; font-size: small;">RADIACION LASER NON FISSARE IL FASCIO</p> <p style="font-size: x-small;">Potenza max. (peak): 3 mW Durata dell'impulso: 8 µs Lunghezza d'onda: 670 nm</p> <p style="text-align: center; font-size: x-small;">APPARECCHIO LASER DI CLASSE 2 EN 60825-1:2007</p>
<p style="text-align: center; font-size: small;">LASER RADIATION DO NOT STARE INTO BEAM</p> <p style="font-size: x-small;">Maximum Output (peak): 3 mW Pulse duration: 8 µs Wavelength: 670 nm</p> <p style="text-align: center; font-size: x-small;">CLASS 2 LASER PRODUCT EN 60825-1:2007</p>	<p style="text-align: center; font-size: small;">RAYONNEMENT LASER NE PAS REGARDER DANS LE FASCEAU</p> <p style="font-size: x-small;">Puissance max. (crête): 3 mW Durée d'impulsion: 8 µs Longueur d'onde: 670 nm</p> <p style="text-align: center; font-size: x-small;">APPAREIL À LASER DE CLASSE 2 EN 60825-1:2007</p>
<p style="font-size: x-small;">AVOID EXPOSURE – LASER RADIATION IS EMITTED FROM THIS APERTURE</p>	<p style="font-size: x-small;">EXPOSITION DANGEREUSE – UN RAYONNEMENT LASER EST EMIS PAR CETTE OUVERTURE</p>
<p style="text-align: center; font-size: small;">RADIACION LASER NO MIRAR FIJAMENTE AL HAZ</p> <p style="font-size: x-small;">Potencia max. (peak): 3 mW Duración del impulso: 8 µs Longitud de onda: 670 nm</p> <p style="text-align: center; font-size: x-small;">PRODUCTO LASER DE CLASE 2 EN 60825-1:2007</p>	<p style="text-align: center; font-size: small;">RADIACÃO LASER NÃO OLHAR FIXAMENTE O FEIXE</p> <p style="font-size: x-small;">Potência máx. (peak): 3 mW Período de pulso: 8 µs Comprimento de onda: 670 nm</p> <p style="text-align: center; font-size: x-small;">EQUIPAMENTO LASER CLASSE 2 EN 60825-1:2007</p>
<p style="text-align: center; font-size: small;">LASER RADIATION DO NOT STARE INTO BEAM</p> <p style="font-size: x-small;">Maximum Output (peak): 3 mW Pulse duration: 8 µs Wavelength: 670 nm</p> <p style="text-align: center; font-size: x-small;">CLASS 2 LASER PRODUCT EN 60825-1:2007 Complies with 21 CFR 1040.10</p>	<p style="text-align: center; font-size: small;">激光辐射 勿直视光束</p> <p style="font-size: x-small;">最大输出 (峰值): 3 mW 脉冲持续时间: 8 µs 波长: 670 nm</p> <p style="text-align: center; font-size: x-small;">2 类激光产品 GB7247.1-2012</p>

