

LSR 3B

Throughbeam photoelectric sensors

en 04-2016/01 50108961

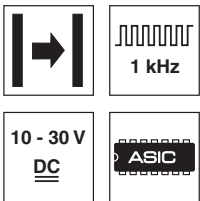

0 ... 10m

- Throughbeam photoelectric sensor with visible red light
- High performance reserve
- Small and compact construction with robust plastic housing, protection class IP 67 for industrial application
- Fast alignment through *brightVision*®
- Push-pull switching outputs
- High switching frequency for detection of fast events
- Warning output for increased availability
- Activation input

Dimensioned drawing

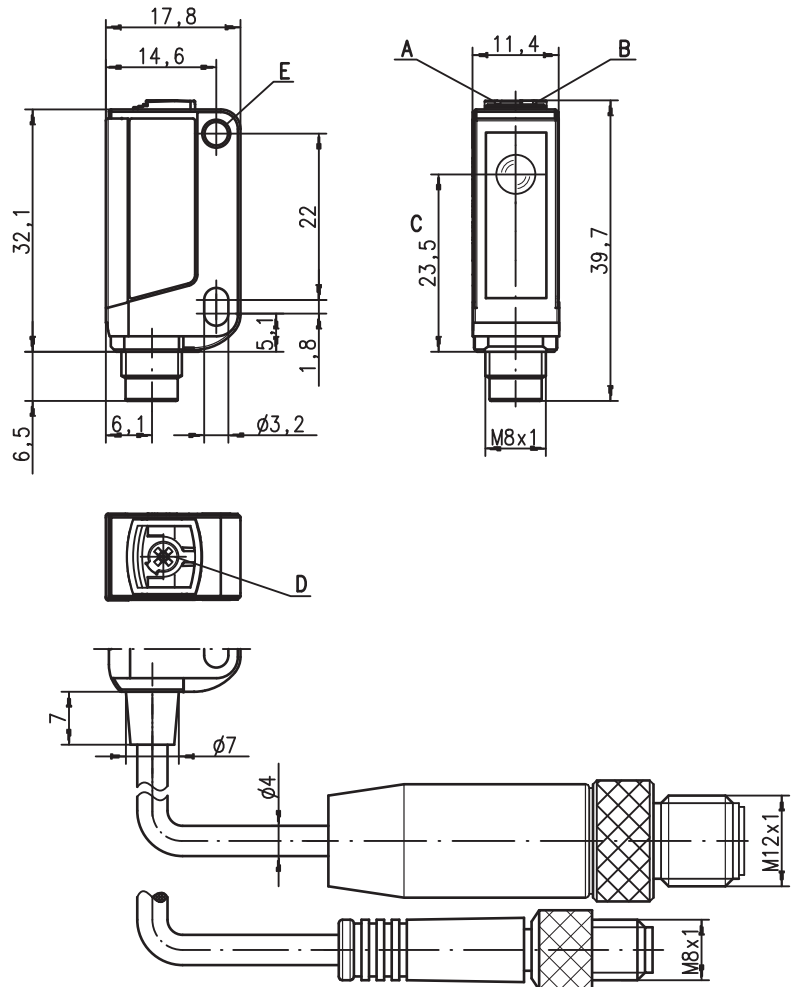

- A Green indicator diode
- B Yellow indicator diode
- C Optical axis
- D Potentiometer for operating range adjustment (LSR 3B/66.1... only)
- E Attachment sleeve

Electrical connection

Plug connection, 4-pin

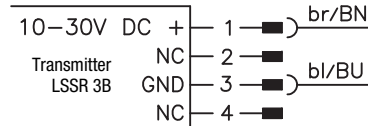

Cable, 4-wire

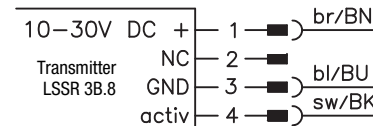
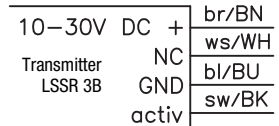

Plug connection, 4-pin

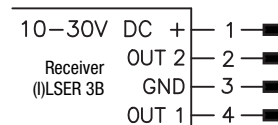

Cable, 4-wire

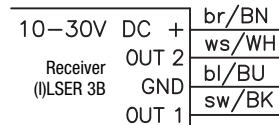

Accessories:

(available separately)

- Mounting systems (BT 3...)
- Cable with M8 connector (K-D ...)
- Reflectors
- Reflective tapes

We reserve the right to make changes • DS\_LSR3B\_en\_50108961.fm



## Specifications

### Optical data

Typ. operating range limit <sup>1)</sup>	0 ... 10m
Operating range <sup>2)</sup>	0.05 ... 8.5m
Light source <sup>3)</sup>	LED (modulated light)
Wavelength	620nm (visible red light)

### Timing

Switching frequency	1,000Hz (see order guide)
Response time	0.5ms
Delay before start-up	≤ 300ms

### Electrical data

Operating voltage $U_B$ <sup>4)</sup>	10 ... 30VDC (incl. residual ripple)
Residual ripple	≤ 15% of $U_B$
Open-circuit current	≤ 14mA (per sensor)
Switching output	.../66 <sup>5)</sup> 2 push-pull switching outputs pin 2: PNP dark switching, NPN light switching pin 4: PNP light switching, NPN dark switching .../6 <sup>5)</sup> 1 push-pull switching output pin 4: PNP light switching, NPN dark switching light/dark switching
Function characteristics	permanently set or adjustable, see order guide
Signal voltage high/low	$\geq (U_B - 2V) / \leq 2V$
Output current	max. 100mA
Operating range	

### Indicators

Green LED	ready
Yellow LED	light path free
Yellow LED, flashing	light path free, no performance reserve

### Mechanical data

Housing <sup>6)</sup>	plastic (PC-ABS); 1 attachment sleeve, nickel-plated steel
Optics cover	plastic (PMMA)
Weight	with connector: 10g with 200mm cable and connector: 20g with 2m cable: 50g
Connection type	2m/5m cable (cross section 4x0.20mm <sup>2</sup> ), connector M8 metal, 0.2m cable with connector M8

### Environmental data

Ambient temp. (operation/storage)	-30°C ... +55°C / -30°C ... +70°C
Protective circuit <sup>7)</sup>	2, 3
VDE safety class	III
Protection class	IP 67
Light source	free group (in accordance with EN 62471)
Standards applied	IEC 60947-5-2
Certifications	UL 508, CSA C22.2 No.14-13 <sup>4) 8)</sup>

### Options

<b>Warning output autoControl warn</b>	PNP transistor, counting principle
Signal voltage high/low	$\geq (U_B - 2V) / \leq 2V$
Output current	max. 100mA
<b>Activation input active</b>	
Transmitter active/not active	$\geq 8V / \leq 2V$
Activation/disable delay	≤ 1ms
Input resistance	10KΩ ± 10%

- 1) Typ. operating range limit: max. attainable range without performance reserve
- 2) Operating range: recommended range with performance reserve
- 3) Average life expectancy 100,000h at an ambient temperature of 25°C
- 4) For UL applications: for use in class 2 circuits according to NEC only
- 5) The push-pull switching outputs must not be connected in parallel
- 6) Patent Pending Publ. No. US 7,476,848 B2
- 7) 2=polarity reversal protection, 3=short-circuit protection for all transistor outputs
- 8) These proximity switches shall be used with UL Listed Cable assemblies rated 30V, 0.5A min, in the field installation, or equivalent (categories: CYJV/CYJV7 or PVVA/PVVA7)

## Remarks

### Operate in accordance with intended use!

- ⚠ This product is not a safety sensor and is not intended as personnel protection.
- ⚠ The product may only be put into operation by competent persons.
- ⚠ Only use the product in accordance with the intended use.

### UL REQUIREMENTS

Enclosure Type Rating: Type 1

#### For Use in NFPA 79 Applications only.

Adapters providing field wiring means are available from the manufacturer. Refer to manufacturers information.

**CAUTION** – the use of controls or adjustments or performance of procedures other than those specified herein may result in hazardous radiation exposure.

**ATTENTION!** Si d'autres dispositifs d'alignement que ceux préconisés ici sont utilisés ou s'il est procédé autrement qu'indiqué, cela peut entraîner une exposition à des rayonnements et un danger pour les personnes.

## Tables

0	8,5	10
---	-----	----

	Operating range [m]
	Typ. operating range limit [m]

## Diagrams

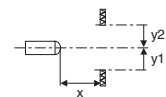
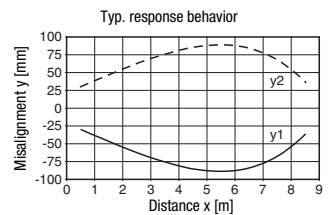

## Remarks

A light axis consists of a transmitter and a receiver with the following designations:

- [T]LSR = Complete light axis
- LSSR = Transmitter
- [R]LSER = Receiver

### Mounting system:



- ① = BT 3 (part no. 50060511)
- ②+③ = BT 3.1 <sup>1)</sup> (part no. 50105585)
- ①+②+③ = BT 3B (part no. 50105546)

1) Packaging unit: PU = 10 pcs.

**LSR 3B**

**Throughbeam photoelectric sensors**

**Order guide**

Selection table			Order code →										
Equipment ↓			LSR 3B/66-S8 Part no. 50108508 (Tr) Part no. 50108514 (Re)	LSR 3B/66.8-S8 Part no. 50108509 (Tr) Part no. 50108514 (Re)	LSR 3B/66.1-S8 Part no. 50108508 (Tr) Part no. 50108515 (Re)	LSR 3B/66.8 Part no. 50108510 (Tr) Part no. 50108516 (Re)	ILSR 3B/4-S8 Part no. 50108508 (Tr) Part no. 50108517 (Re)	ILSR 3B/4.8.200-S8 Part no. 50108512 (Tr) Part no. 50108518 (Re)	LSR 3B/66.8.5000 Part no. 50108511 (Tr) Part no. 50108519 (Re)	LSR 3B/66.8.200-S12 Part no. 50111441 (Tr) Part no. 50111442 (Re)	LSR 3B/66.200-S12 Part no. 50111440 (Tr) Part no. 50111442 (Re)		
Output 1 (OUT 1)	push-pull switching output	light switching	○	●	●	●	●			●	●	●	
		dark switching	●										
	PNP transistor output	light switching	○				●	●					
		dark switching	●										
	NPN transistor output	light switching	○										
		dark switching	●										
Output 2 (OUT 2)	push-pull switching output	light switching	○	●	●	●			●	●	●		
		dark switching	●										
	PNP transistor output	light switching	○										
		dark switching	●										
	NPN transistor output	light switching	○										
		dark switching	●										
warning output (PNP transistor)	light switching	○				●	●						
Connection	cable 2,000mm	4-wire				●							
	M8 connector, metal	3-pin											
	M8 connector, metal	4-pin	●	●	●		●						
	M8 connector, metal, snap-on	4-pin											
	200mm cable with M8 connector	3-pin											
	200mm cable with M8 connector	4-pin						●					
	200mm cable with M12 connector	4-pin								●	●		
cable 5,000mm	4-wire							●					
Configuration	permanently set to maximum range		●	●		●	●	●	●	●	●		
	potentiometer, rotational angle approx. 250°				●								
Features	activation input			●		●		●	●	●			



- Adapter plate: BT 3.2 (part no. 50103844) for alternate mounting on 25.4mm hole spacing (Omron E3Z, Sick W100...)

