



**Part no.: 50135741**  
**LCS-1Q40P-F20PNC-K003PM08**  
**Capacitive sensor**



Figure can vary

## Contents

- . Technical data
- . Dimensioned drawings
- . Electrical connection
- . Circuit diagrams
- . Operation and display
- . Accessories
- . Notes



## Technical data

<b>Basic data</b>	
Series	LCS-1
Switching distance $S_n$	1 ... 20 mm
Assured switching distance	20 mm

<b>Electrical data</b>	
Protective circuit	Short circuit protected Polarity reversal protection

<b>Performance data</b>	
Supply voltage	10 ... 30 V, DC
Residual ripple	0 ... 10 %, From $U_B$
Open-circuit current	15 mA
Temperature drift, max. (in % of $S_r$ )	20 %
Repeatability, max. (in % of $S_r$ )	5 %
Rated operating current	100 mA

<b>Outputs</b>	
Number of digital switching outputs	1 Piece(s)

<b>Switching outputs</b>	
Type	Digital switching output
Voltage type	DC

<b>Switching output 1</b>	
Assignment	Connection 1, pin 4
Switching element	Transistor, PNP
Switching principle	NC (normally closed)

<b>Timing</b>	
Switching frequency	100 Hz

<b>Connection</b>	
Number of connections	1 Piece(s)

<b>Connection 1</b>	
Type of connection	Connector
Function	Voltage supply Signal OUT
Cable length	300 mm
Sheathing material	PUR
Cable color	Black
Thread size	M8
Type	Male
Material	Plastic
No. of pins	3 -pin

<b>Mechanical data</b>	
Design	Cubic
Dimension (W x H x L)	40 mm x 40 mm x 10 mm
Type of installation	Embedded
Housing material	Plastic, Polybutylene (PBT)
Sensing face material	Plastic, Polybutylene (PBT)

**Part no.: 50135741 – LCS-1Q40P-F20PNC-K003PM08 – Capacitive sensor**

Cover material	Plastic, Polybutylene (PBT)
Net weight	33 g
Housing color	Black

**Operation and display**

Type of display	LED
Number of LEDs	2 Piece(s)
Switching distance, adjustable	Yes

**Environmental data**

Ambient temperature, operation	-5 ... 85 °C
--------------------------------	--------------

**Certifications**

Degree of protection	IP 67
Protection class	III
Certifications	c UL US
Standards applied	IEC 60947-5-2

**Correction factors**

Acetone	0.75
Acrylic resin	0.1 ... 0.25
Alcohol	0.85
Ammonia	0.7 ... 0.85
Aniline	0.4
Gasoline	0.1
Celluloid	0.15
Liquid chlorine	0.1
Ebonite	0.15
Epoxy resin	0.15 ... 0.35
Crude oil	0.05
Ethanol	0.85
Ethylene glycol	0.93
Freon R22 and 502 (liquid)	0.35
Grain	0.15 ... 0.3
Glass	0.2 ... 0.55
Glycerin	0.98
Rubber	0.15 ... 0.9
Wood, wet	0.6 ... 0.85
Wood, dry	0.1 ... 0.4
Marble	0.5
Flour	0.05
Melamine resin	0.25 ... 0.55
Milk powder	0.2
Nylon	0.2 ... 0.3
Oil-containing paper	0.25
Paper	0.1
Polyamide	0.3
Polyester resin	0.15 ... 0.5
Pressboard	0.1 ... 0.3

Part no.: 50135741 – LCS-1Q40P-F20PNC-K003PM08 – Capacitive sensor

PTFE	0.1
Quartz glass	0.2
Salt	0.35
Sand	0.15 ... 0.3
Water	1
Cement dust	0.25
Sugar	0.15

Classification	
eCl@ss 8.0	27270102
eCl@ss 9.0	27270102
ETIM 5.0	EC002715

## Dimensioned drawings

All dimensions in millimeters

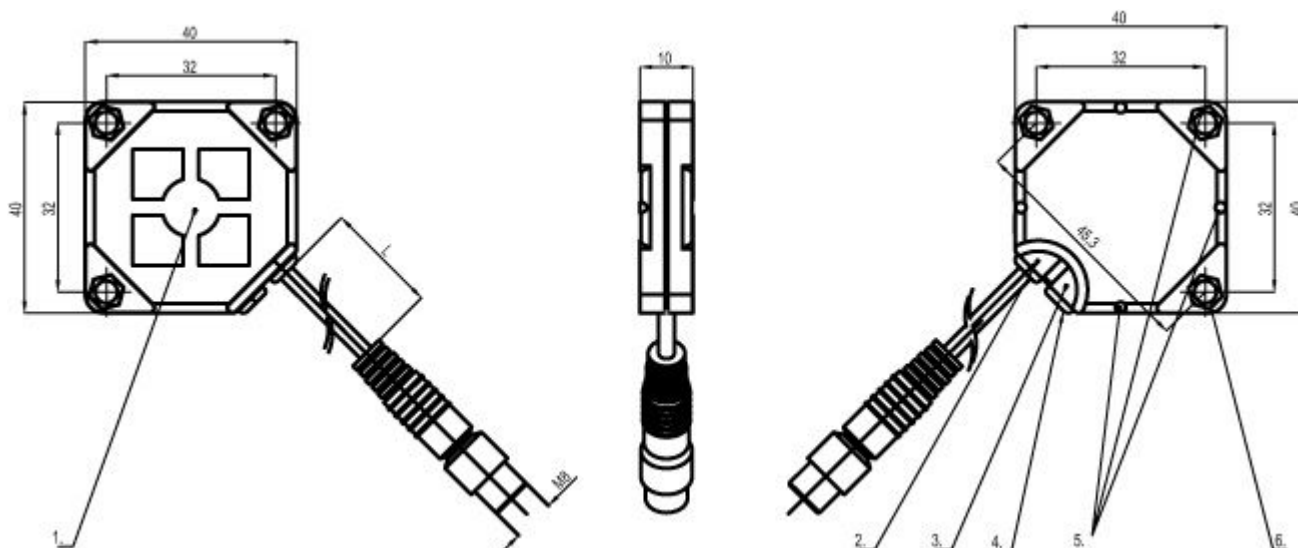

- 1 Active surface
- 2 Green LED, operating voltage display
- 3 Yellow LED, function indicator
- 4 Potentiometer
- 5 Mounting: cable tie
- 6 Mounting: 3xM3 screw

## Electrical connection

Connection 1	
Type of connection	Connector
Function	Voltage supply Signal OUT
Cable length	300 mm
Sheathing material	PUR
Cable color	Black

Part no.: 50135741 – LCS-1Q40P-F20PNC-K003PM08 – Capacitive sensor

Connection 1	
Thread size	M8
Type	Male
Material	Plastic
No. of pins	3 -pin

Pin	Pin assignment	Conductor color
1	+10...30 V DC	Brown
2	OUT	White
3	GND	Blue

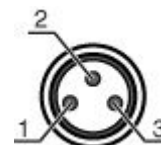

## Circuit diagrams

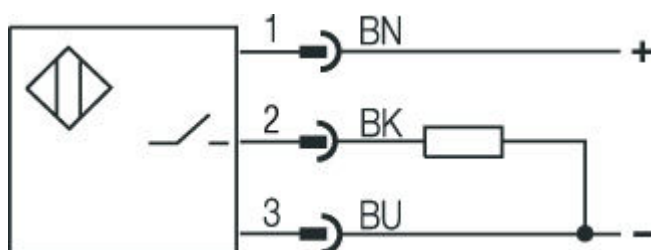



## Operation and display

### LEDs











LED	Display	Meaning
1	Green, continuous light	Ready
2	Yellow, continuous light	Switching output/switching state

## Accessories







### Connection technology - Connection cables

	Part no.	Designation	Article	Description
	50130842	KD U-M8-3A-P1-020	Connection cable	Connection 1: Connector, M8, Axial, Female, 3 -pin Connection 2: Open end Shielded: No Cable length: 2,000 mm Sheathing material: PUR
	50130886	KD U-M8-3A-P1-020-DP	Connection cable	Connection 1: Connector, M8, Axial, Female, 3 -pin Connector, LED: Yes, 1 Piece(s) Connection 2: Open end Shielded: No Cable length: 2,000 mm Sheathing material: PUR

**Part no.: 50135741 – LCS-1Q40P-F20PNC-K003PM08 – Capacitive sensor**

	Part no.	Designation	Article	Description
	50130843	KD U-M8-3A-P1-030	Connection cable	Connection 1: Connector, M8, Axial, Female, 3 -pin Connection 2: Open end Shielded: No Cable length: 3,000 mm Sheathing material: PUR
	50130844	KD U-M8-3A-P1-050	Connection cable	Connection 1: Connector, M8, Axial, Female, 3 -pin Connection 2: Open end Shielded: No Cable length: 5,000 mm Sheathing material: PUR
	50130887	KD U-M8-3A-P1-050-DP	Connection cable	Connection 1: Connector, M8, Axial, Female, 3 -pin Connector, LED: Yes, 1 Piece(s) Connection 2: Open end Shielded: No Cable length: 5,000 mm Sheathing material: PUR
	50130845	KD U-M8-3A-P1-100	Connection cable	Connection 1: Connector, M8, Axial, Female, 3 -pin Connection 2: Open end Shielded: No Cable length: 10,000 mm Sheathing material: PUR
	50130888	KD U-M8-3A-P1-100-DP	Connection cable	Connection 1: Connector, M8, Axial, Female, 3 -pin Connector, LED: Yes, 1 Piece(s) Connection 2: Open end Shielded: No Cable length: 10,000 mm Sheathing material: PUR
	50130846	KD U-M8-3A-P1-150	Connection cable	Connection 1: Connector, M8, Axial, Female, 3 -pin Connection 2: Open end Shielded: No Cable length: 15,000 mm Sheathing material: PUR
	50130847	KD U-M8-3A-P1-200	Connection cable	Connection 1: Connector, M8, Axial, Female, 3 -pin Connection 2: Open end Shielded: No Cable length: 20,000 mm Sheathing material: PUR
	50130837	KD U-M8-3A-V1-020	Connection cable	Connection 1: Connector, M8, Axial, Female, 3 -pin Connection 2: Open end Shielded: No Cable length: 2,000 mm Sheathing material: PVC
	50130883	KD U-M8-3A-V1-020-DP	Connection cable	Connection 1: Connector, M8, Axial, Female, 3 -pin Connector, LED: Yes, 1 Piece(s) Connection 2: Open end Shielded: No Cable length: 2,000 mm Sheathing material: PVC
	50130838	KD U-M8-3A-V1-030	Connection cable	Connection 1: Connector, M8, Axial, Female, 3 -pin Connection 2: Open end Shielded: No Cable length: 3,000 mm Sheathing material: PVC

Part no.: 50135741 – LCS-1Q40P-F20PNC-K003PM08 – Capacitive sensor

	Part no.	Designation	Article	Description
	50130832	KD U-M8-3A-V1-050	Connection cable	Connection 1: Connector, M8, Axial, Female, 3 -pin Connection 2: Open end Shielded: No Cable length: 5,000 mm Sheathing material: PVC
	50130884	KD U-M8-3A-V1-050-DP	Connection cable	Connection 1: Connector, M8, Axial, Female, 3 -pin Connector, LED: Yes, 1 Piece(s) Connection 2: Open end Shielded: No Cable length: 5,000 mm Sheathing material: PVC
	50130839	KD U-M8-3A-V1-100	Connection cable	Connection 1: Connector, M8, Axial, Female, 3 -pin Connection 2: Open end Shielded: No Cable length: 10,000 mm Sheathing material: PVC
	50130885	KD U-M8-3A-V1-100-DP	Connection cable	Connection 1: Connector, M8, Axial, Female, 3 -pin Connector, LED: Yes, 1 Piece(s) Connection 2: Open end Shielded: No Cable length: 10,000 mm Sheathing material: PVC
	50130840	KD U-M8-3A-V1-150	Connection cable	Connection 1: Connector, M8, Axial, Female, 3 -pin Connection 2: Open end Shielded: No Cable length: 15,000 mm Sheathing material: PVC
	50130841	KD U-M8-3A-V1-200	Connection cable	Connection 1: Connector, M8, Axial, Female, 3 -pin Connection 2: Open end Shielded: No Cable length: 20,000 mm Sheathing material: PVC

## Notes

**Observe intended use!**

- This product is not a safety sensor and is not intended as personnel protection.
- The product may only be put into operation by competent persons.
- Only use the product in accordance with its intended use.