

Part no.: 50135789
LCS-1M30M-N25NNO-M12
Capacitive sensor



Figure can vary

Contents

- . Technical data
- . Dimensioned drawings
- . Electrical connection
- . Circuit diagrams
- . Operation and display
- . Accessories
- . Notes



Part no.: 50135789 – LCS-1M30M-N25NNO-M12 – Capacitive sensor

Technical data

| Basic data | |
|----------------------------|-------------|
| Series | LCS-1 |
| Switching distance S_n | 1 ... 25 mm |
| Assured switching distance | 25 mm |

| Electrical data | |
|------------------------|---|
| Protective circuit | Polarity reversal protection Short circuit protected |

| Performance data | |
|--|------------------------|
| Supply voltage | 10 ... 30 V, DC |
| Residual ripple | 0 ... 10 %, From U_B |
| Open-circuit current | 15 mA |
| Temperature drift, max. (in % of S_r) | 20 % |
| Repeatability, max. (in % of S_r) | 2 % |
| Rated operating current | 100 mA |

| Outputs | |
|-------------------------------------|------------|
| Number of digital switching outputs | 1 Piece(s) |

| Switching outputs | |
|--------------------------|--------------------------|
| Type | Digital switching output |
| Voltage type | DC |

| Switching output 1 | |
|---------------------------|---------------------|
| Assignment | Connection 1, pin 2 |
| Switching element | Transistor, NPN |
| Switching principle | NO (normally open) |

| Timing | |
|---------------------|--------|
| Switching frequency | 100 Hz |

| Connection | |
|-----------------------|------------|
| Number of connections | 1 Piece(s) |

| Connection 1 | |
|---------------------|------------------------------|
| Type of connection | Connector |
| Function | Signal OUT Voltage supply |
| Thread size | M12 |
| Type | Male |
| Material | Plastic |
| No. of pins | 3 -pin |
| Encoding | A-coded |

| Mechanical data | |
|--------------------------------|---|
| Design | Cylindrical |
| Thread size | M30 x 1.5 mm |
| Dimension (\varnothing x L) | 30 mm x 78.5 mm |
| Type of installation | Non-embedded |
| Housing material | Metal Stainless steel, V2A |
| Sensing face material | Plastic, Polybutylene (PBT) |
| Cover material | Plastic, Polybutylene (PBT)/polyamide (PA 12) |

Part no.: 50135789 – LCS-1M30M-N25NNO-M12 – Capacitive sensor

| | |
|------------|------|
| Net weight | 87 g |
|------------|------|

Operation and display

| | |
|--------------------------------|------------|
| Type of display | LED |
| Number of LEDs | 2 Piece(s) |
| Switching distance, adjustable | Yes |

Environmental data

| | |
|--------------------------------|---------------|
| Ambient temperature, operation | -25 ... 85 °C |
|--------------------------------|---------------|

Certifications

| | |
|----------------------|---------------|
| Degree of protection | IP 67 |
| Protection class | III |
| Certifications | c UL US |
| Standards applied | IEC 60947-5-2 |

Correction factors

| | |
|----------------------------|---------------|
| Acetone | 0.75 |
| Acrylic resin | 0.1 ... 0.25 |
| Alcohol | 0.85 |
| Ammonia | 0.7 ... 0.85 |
| Aniline | 0.4 |
| Gasoline | 0.1 |
| Celluloid | 0.15 |
| Liquid chlorine | 0.1 |
| Ebonite | 0.15 |
| Epoxy resin | 0.15 ... 0.35 |
| Crude oil | 0.05 |
| Ethanol | 0.85 |
| Ethylene glycol | 0.93 |
| Freon R22 and 502 (liquid) | 0.35 |
| Grain | 0.15 ... 0.3 |
| Glass | 0.2 ... 0.55 |
| Glycerin | 0.98 |
| Rubber | 0.15 ... 0.9 |
| Wood, wet | 0.6 ... 0.85 |
| Wood, dry | 0.1 ... 0.4 |
| Marble | 0.5 |
| Flour | 0.05 |
| Melamine resin | 0.25 ... 0.55 |
| Milk powder | 0.2 |
| Nylon | 0.2 ... 0.3 |
| Oil-containing paper | 0.25 |
| Paper | 0.1 |
| Polyamide | 0.3 |
| Polyester resin | 0.15 ... 0.5 |
| Pressboard | 0.1 ... 0.3 |
| PTFE | 0.1 |
| Quartz glass | 0.2 |

Part no.: 50135789 – LCS-1M30M-N25NNO-M12 – Capacitive sensor

| | |
|-------------|--------------|
| Salt | 0.35 |
| Sand | 0.15 ... 0.3 |
| Water | 1 |
| Cement dust | 0.25 |
| Sugar | 0.15 |

| Classification | |
|----------------|----------|
| eCl@ss 8.0 | 27270102 |
| eCl@ss 9.0 | 27270102 |
| ETIM 5.0 | EC002715 |

Dimensioned drawings

All dimensions in millimeters

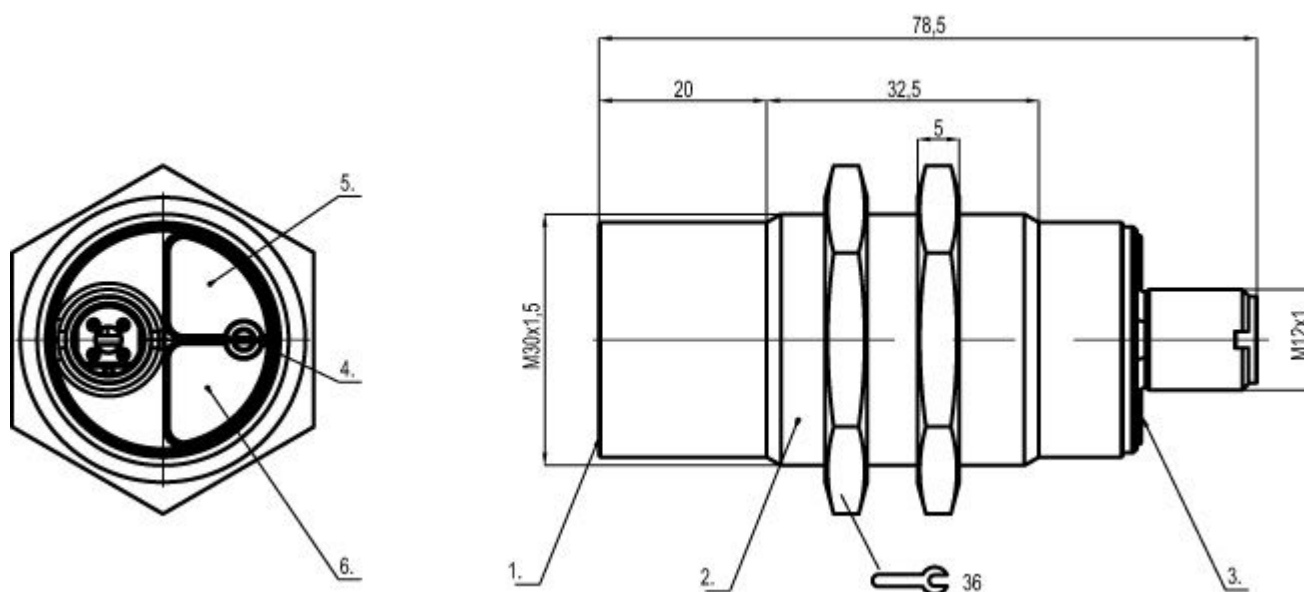

- 1 Active surface
- 2 Housing
- 3 Cover
- 4 Potentiometer
- 5 Green LED, operating voltage display
- 6 Yellow LED, function indicator

Electrical connection

| Connection 1 | |
|--------------------|------------------------------|
| Type of connection | Connector |
| Function | Signal OUT Voltage supply |
| Thread size | M12 |
| Type | Male |
| Material | Plastic |
| No. of pins | 3 -pin |

Part no.: 50135789 – LCS-1M30M-N25NNO-M12 – Capacitive sensor

| Connection 1 | |
|--------------|---------|
| Encoding | A-coded |

| Pin | Pin assignment | Conductor color |
|-----|----------------|-----------------|
| 1 | +10...30 V DC | Brown |
| 2 | OUT | Black |
| 3 | GND | Blue |

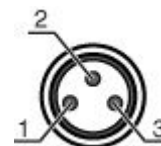

Circuit diagrams

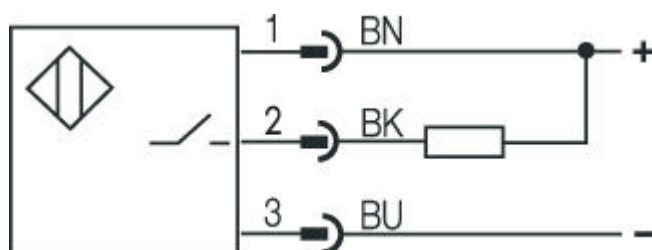



Operation and display

LEDs







| LED | Display | Meaning |
|-----|--------------------------|----------------------------------|
| 1 | Green, continuous light | Ready |
| 2 | Yellow, continuous light | Switching output/switching state |

Accessories

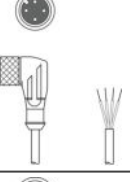
Connection technology - Connection cables

| | Part no. | Designation | Article | Description |
|---|----------|---------------------|------------------|--|
|  | 50112960 | K-D M12A-4P-10m-FAB | Connection cable | Connection 1: Connector, M12, Axial, Female, A-coded, 4 -pin Connection 2: Open end Shielded: No Cable length: 10,000 mm Sheathing material: FAB |
|  | 50104570 | K-D M12A-4P-2m-FAB | Connection cable | Connection 1: Connector, M12, Axial, Female, A-coded, 4 -pin Connection 2: Open end Shielded: No Cable length: 2,000 mm Sheathing material: FAB |

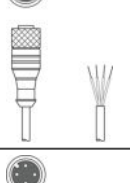
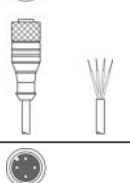
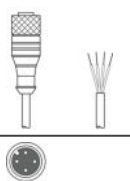

Part no.: 50135789 – LCS-1M30M-N25NNO-M12 – Capacitive sensor

| | Part no. | Designation | Article | Description |
|---|----------|-----------------------|------------------|---|
|  | 50104572 | K-D M12A-4P-5m-FAB | Connection cable | Connection 1: Connector, M12, Axial, Female, A-coded, 4 -pin Connection 2: Open end Shielded: No Cable length: 5,000 mm Sheathing material: FAB |
|  | 50112961 | K-D M12W-4P-10m-FAB | Connection cable | Connection 1: Connector, M12, Angled, Female, A-coded, 4 -pin Connection 2: Open end Shielded: No Cable length: 10,000 mm Sheathing material: FAB |
|  | 50104571 | K-D M12W-4P-2m-FAB | Connection cable | Connection 1: Connector, M12, Angled, Female, A-coded, 4 -pin Connection 2: Open end Shielded: No Cable length: 2,000 mm Sheathing material: FAB |
|  | 50104573 | K-D M12W-4P-5m-FAB | Connection cable | Connection 1: Connector, M12, Angled, Female, A-coded, 4 -pin Connection 2: Open end Shielded: No Cable length: 5,000 mm Sheathing material: FAB |
|  | 50130654 | KD U-M12-4A-P1-020 | Connection cable | Connection 1: Connector, M12, Axial, Female, A-coded, 4 -pin Connection 2: Open end Shielded: No Cable length: 2,000 mm Sheathing material: PUR |
|  | 50130672 | KD U-M12-4A-P1-020-DP | Connection cable | Connection 1: Connector, M12, Axial, Female, A-coded, 4 -pin Connector, LED: Yes, 1 Piece(s) Connection 2: Open end Shielded: No Cable length: 2,000 mm Sheathing material: PUR |
|  | 50130657 | KD U-M12-4A-P1-050 | Connection cable | Connection 1: Connector, M12, Axial, Female, A-coded, 4 -pin Connection 2: Open end Shielded: No Cable length: 5,000 mm Sheathing material: PUR |
|  | 50130675 | KD U-M12-4A-P1-050-DP | Connection cable | Connection 1: Connector, M12, Axial, Female, A-coded, 4 -pin Connector, LED: Yes, 1 Piece(s) Connection 2: Open end Shielded: No Cable length: 5,000 mm Sheathing material: PUR |
|  | 50130658 | KD U-M12-4A-P1-100 | Connection cable | Connection 1: Connector, M12, Axial, Female, A-coded, 4 -pin Connection 2: Open end Shielded: No Cable length: 10,000 mm Sheathing material: PUR |
|  | 50130676 | KD U-M12-4A-P1-100-DP | Connection cable | Connection 1: Connector, M12, Axial, Female, A-coded, 4 -pin Connector, LED: Yes, 1 Piece(s) Connection 2: Open end Shielded: No Cable length: 10,000 mm Sheathing material: PUR |

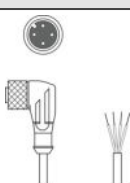

Part no.: 50135789 – LCS-1M30M-N25NNO-M12 – Capacitive sensor

| | Part no. | Designation | Article | Description |
|---|----------|-----------------------|------------------|---|
|  | 50130648 | KD U-M12-4A-V1-020 | Connection cable | Connection 1: Connector, M12, Axial, Female, A-coded, 4 -pin Connection 2: Open end Shielded: No Cable length: 2,000 mm Sheathing material: PVC |
|  | 50130652 | KD U-M12-4A-V1-050 | Connection cable | Connection 1: Connector, M12, Axial, Female, A-coded, 4 -pin Connection 2: Open end Shielded: No Cable length: 5,000 mm Sheathing material: PVC |
|  | 50130653 | KD U-M12-4A-V1-100 | Connection cable | Connection 1: Connector, M12, Axial, Female, A-coded, 4 -pin Connection 2: Open end Shielded: No Cable length: 10,000 mm Sheathing material: PVC |
|  | 50132431 | KD U-M12-4A-V1-200 | Connection cable | Connection 1: Connector, M12, Axial, Female, A-coded, 4 -pin Connection 2: Open end Shielded: No Cable length: 20,000 mm Sheathing material: PVC |
|  | 50132430 | KD U-M12-4A-V1-300 | Connection cable | Connection 1: Connector, M12, Axial, Female, A-coded, 4 -pin Connection 2: Open end Shielded: No Cable length: 30,000 mm Sheathing material: PVC |
|  | 50130692 | KD U-M12-4W-P1-020 | Connection cable | Connection 1: Connector, M12, Angled, Female, A-coded, 4 -pin Connection 2: Open end Shielded: No Cable length: 2,000 mm Sheathing material: PUR |
|  | 50130718 | KD U-M12-4W-P1-020-DP | Connection cable | Connection 1: Connector, M12, Angled, Female, A-coded, 4 -pin Connector, LED: Yes, 1 Piece(s) Connection 2: Open end Shielded: No Cable length: 2,000 mm Sheathing material: PUR |
|  | 50130694 | KD U-M12-4W-P1-050 | Connection cable | Connection 1: Connector, M12, Angled, Female, A-coded, 4 -pin Connection 2: Open end Shielded: No Cable length: 5,000 mm Sheathing material: PUR |
|  | 50130720 | KD U-M12-4W-P1-050-DP | Connection cable | Connection 1: Connector, M12, Angled, Female, A-coded, 4 -pin Connector, LED: Yes, 1 Piece(s) Connection 2: Open end Shielded: No Cable length: 5,000 mm Sheathing material: PUR |
|  | 50130695 | KD U-M12-4W-P1-100 | Connection cable | Connection 1: Connector, M12, Angled, Female, A-coded, 4 -pin Connection 2: Open end Shielded: No Cable length: 10,000 mm Sheathing material: PUR |

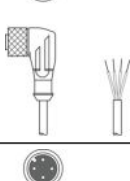
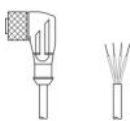
Part no.: 50135789 – LCS-1M30M-N25NNO-M12 – Capacitive sensor

| | Part no. | Designation | Article | Description |
|---|----------|-----------------------|------------------|--|
|  | 50130721 | KD U-M12-4W-P1-100-DP | Connection cable | Connection 1: Connector, M12, Angled, Female, A-coded, 4 -pin Connector, LED: Yes, 1 Piece(s) Connection 2: Open end Shielded: No Cable length: 10,000 mm Sheathing material: PUR |
|  | 50130688 | KD U-M12-4W-V1-020 | Connection cable | Connection 1: Connector, M12, Angled, Female, A-coded, 4 -pin Connection 2: Open end Shielded: No Cable length: 2,000 mm Sheathing material: PVC |
|  | 50130690 | KD U-M12-4W-V1-050 | Connection cable | Connection 1: Connector, M12, Angled, Female, A-coded, 4 -pin Connection 2: Open end Shielded: No Cable length: 5,000 mm Sheathing material: PVC |
|  | 50130691 | KD U-M12-4W-V1-100 | Connection cable | Connection 1: Connector, M12, Angled, Female, A-coded, 4 -pin Connection 2: Open end Shielded: No Cable length: 10,000 mm Sheathing material: PVC |
|  | 50132641 | KD U-M12-4W-V1-200 | Connection cable | Connection 1: Connector, M12, Angled, Female, A-coded, 4 -pin Connection 2: Open end Shielded: No Cable length: 20,000 mm Sheathing material: PVC |

Mounting technology - Other

| | Part no. | Designation | Article | Description |
|---|----------|-------------|---------|--|
|  | 50132730 | AC D30M-CS | Clamp | Contains: 2x M36 mounting nut Diameter, inner: 30 mm Design of mounting device: Mounting clamp Mounting bracket, at system: Screw type, Through-hole mounting Mounting bracket, at device: Insertable, Clampable with limit stop Type of mounting device: Clampable, With limit stop Material: Metal |
|  | 50111503 | MC 030K | Clamp | Diameter, inner: 30 mm Design of mounting device: Mounting clamp Mounting bracket, at system: Through-hole mounting Mounting bracket, at device: Clampable Type of mounting device: Rigid Material: Plastic |
|  | 50111504 | MC 030K-LS | Clamp | Diameter, inner: 30 mm Design of mounting device: Mounting clamp Mounting bracket, at system: Through-hole mounting Mounting bracket, at device: Clampable with limit stop Type of mounting device: Rigid Material: Plastic |

Notes

Observe intended use!

- This product is not a safety sensor and is not intended as personnel protection.
- The product may only be put into operation by competent persons.
- Only use the product in accordance with its intended use.