



**Part no.: 50135714**  
**LCS-1M18P-F08NNO-M12**  
**Capacitive sensor**



Figure can vary

## Contents

- . Technical data
- . Dimensioned drawings
- . Electrical connection
- . Circuit diagrams
- . Operation and display
- . Accessories
- . Notes



## Technical data

<b>Basic data</b>	
Series	LCS-1
Switching distance $S_n$	1 ... 8 mm
Assured switching distance	8 mm

<b>Electrical data</b>	
Protective circuit	Polarity reversal protection Short circuit protected

<b>Performance data</b>	
Supply voltage	10 ... 30 V, DC
Residual ripple	0 ... 10 %, From $U_B$
Open-circuit current	15 mA
Temperature drift, max. (in % of $S_r$ )	20 %
Repeatability, max. (in % of $S_r$ )	2 %
Rated operating current	100 mA

<b>Outputs</b>	
Number of digital switching outputs	1 Piece(s)

<b>Switching outputs</b>	
Type	Digital switching output
Voltage type	DC

<b>Switching output 1</b>	
Assignment	Connection 1, pin 4
Switching element	Transistor, NPN
Switching principle	NO (normally open)

<b>Timing</b>	
Switching frequency	100 Hz

<b>Connection</b>	
Number of connections	1 Piece(s)

<b>Connection 1</b>	
Type of connection	Connector
Function	Voltage supply Signal OUT
Thread size	M12
Type	Male
Material	Plastic
No. of pins	4 -pin
Encoding	A-coded

<b>Mechanical data</b>	
Design	Cylindrical
Thread size	M18 x 1 mm
Dimension ( $\varnothing$ x L)	18 mm x 88.5 mm
Type of installation	Embedded
Housing material	Plastic, Polybutylene (PBT)
Sensing face material	Plastic, Polybutylene (PBT)
Cover material	Plastic, Polybutylene (PBT)/polyamide (PA 12)

**Part no.: 50135714 – LCS-1M18P-F08NNO-M12 – Capacitive sensor**

Net weight	21 g
------------	------

**Operation and display**

Type of display	LED
Number of LEDs	2 Piece(s)
Switching distance, adjustable	Yes

**Environmental data**

Ambient temperature, operation	-25 ... 85 °C
--------------------------------	---------------

**Certifications**

Degree of protection	IP 67
Protection class	III
Certifications	c UL US
Standards applied	IEC 60947-5-2

**Correction factors**

Acetone	0.75
Acrylic resin	0.1 ... 0.25
Alcohol	0.85
Ammonia	0.7 ... 0.85
Aniline	0.4
Gasoline	0.1
Celluloid	0.15
Liquid chlorine	0.1
Ebonite	0.15
Epoxy resin	0.15 ... 0.35
Crude oil	0.05
Ethanol	0.85
Ethylene glycol	0.93
Freon R22 and 502 (liquid)	0.35
Grain	0.15 ... 0.3
Glass	0.2 ... 0.55
Glycerin	0.98
Rubber	0.15 ... 0.9
Wood, wet	0.6 ... 0.85
Wood, dry	0.1 ... 0.4
Carbon dioxide	0
Air	0
Marble	0.5
Flour	0.05
Melamine resin	0.25 ... 0.55
Milk powder	0.2
Nylon	0.2 ... 0.3
Oil-containing paper	0.25
Paper	0.1
Polyamide	0.3
Polyester resin	0.15 ... 0.5
Pressboard	0.1 ... 0.3

PTFE	0.1
Quartz glass	0.2
Salt	0.35
Sand	0.15 ... 0.3
Water	1
Cement dust	0.25
Sugar	0.15

**Classification**

eCl@ss 8.0	27270102
eCl@ss 9.0	27270102
ETIM 5.0	EC002715

## Dimensioned drawings

All dimensions in millimeters

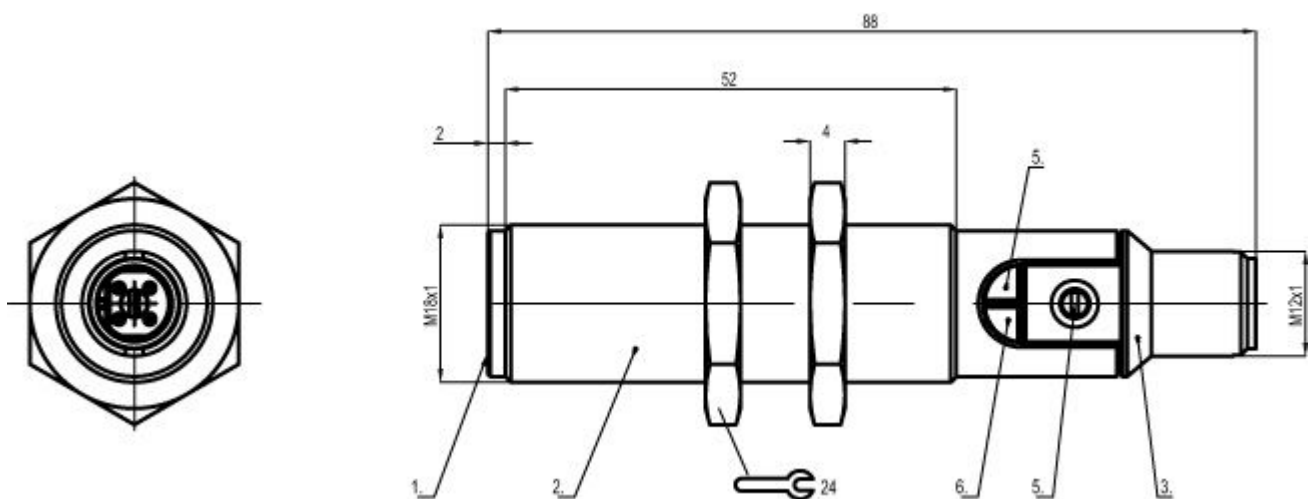

- 1 Active surface
- 2 Housing
- 3 Cover
- 4 Potentiometer
- 5 Green LED, operating voltage display
- 6 Yellow LED, function indicator

## Electrical connection

Connection 1	
Type of connection	Connector
Function	Voltage supply Signal OUT
Thread size	M12
Type	Male
Material	Plastic
No. of pins	4 -pin

Part no.: 50135714 – LCS-1M18P-F08NNO-M12 – Capacitive sensor

<b>Connection 1</b>	
Encoding	A-coded

Pin	Pin assignment	Conductor color
1	+10...30 V DC	Brown
2	n.c.	White
3	GND	Blue
4	OUT	Black

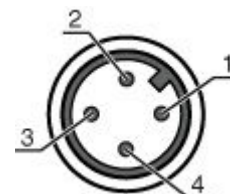

## Circuit diagrams

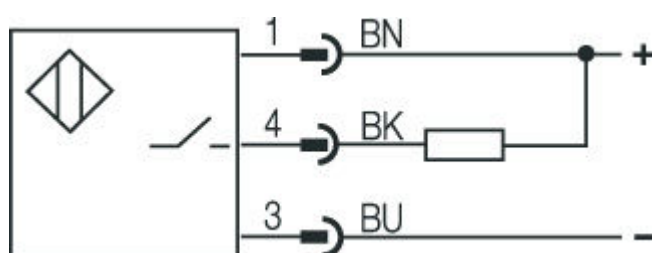



## Operation and display

### LEDs









LED	Display	Meaning
1	Green, continuous light	Ready
2	Yellow, continuous light	Switching output/switching state

## Accessories

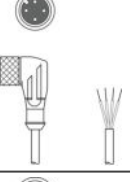
### Connection technology - Connection cables

	Part no.	Designation	Article	Description
	50112960	K-D M12A-4P-10m-FAB	Connection cable	Connection 1: Connector, M12, Axial, Female, A-coded, 4 -pin Connection 2: Open end Shielded: No Cable length: 10,000 mm Sheathing material: FAB
	50104570	K-D M12A-4P-2m-FAB	Connection cable	Connection 1: Connector, M12, Axial, Female, A-coded, 4 -pin Connection 2: Open end Shielded: No Cable length: 2,000 mm Sheathing material: FAB

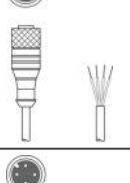
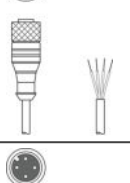
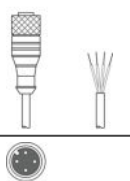

**Part no.: 50135714 – LCS-1M18P-F08NNO-M12 – Capacitive sensor**

	Part no.	Designation	Article	Description
	50104572	K-D M12A-4P-5m-FAB	Connection cable	Connection 1: Connector, M12, Axial, Female, A-coded, 4 -pin Connection 2: Open end Shielded: No Cable length: 5,000 mm Sheathing material: FAB
	50112961	K-D M12W-4P-10m-FAB	Connection cable	Connection 1: Connector, M12, Angled, Female, A-coded, 4 -pin Connection 2: Open end Shielded: No Cable length: 10,000 mm Sheathing material: FAB
	50104571	K-D M12W-4P-2m-FAB	Connection cable	Connection 1: Connector, M12, Angled, Female, A-coded, 4 -pin Connection 2: Open end Shielded: No Cable length: 2,000 mm Sheathing material: FAB
	50104573	K-D M12W-4P-5m-FAB	Connection cable	Connection 1: Connector, M12, Angled, Female, A-coded, 4 -pin Connection 2: Open end Shielded: No Cable length: 5,000 mm Sheathing material: FAB
	50130654	KD U-M12-4A-P1-020	Connection cable	Connection 1: Connector, M12, Axial, Female, A-coded, 4 -pin Connection 2: Open end Shielded: No Cable length: 2,000 mm Sheathing material: PUR
	50130672	KD U-M12-4A-P1-020-DP	Connection cable	Connection 1: Connector, M12, Axial, Female, A-coded, 4 -pin Connector, LED: Yes, 1 Piece(s) Connection 2: Open end Shielded: No Cable length: 2,000 mm Sheathing material: PUR
	50130657	KD U-M12-4A-P1-050	Connection cable	Connection 1: Connector, M12, Axial, Female, A-coded, 4 -pin Connection 2: Open end Shielded: No Cable length: 5,000 mm Sheathing material: PUR
	50130675	KD U-M12-4A-P1-050-DP	Connection cable	Connection 1: Connector, M12, Axial, Female, A-coded, 4 -pin Connector, LED: Yes, 1 Piece(s) Connection 2: Open end Shielded: No Cable length: 5,000 mm Sheathing material: PUR
	50130658	KD U-M12-4A-P1-100	Connection cable	Connection 1: Connector, M12, Axial, Female, A-coded, 4 -pin Connection 2: Open end Shielded: No Cable length: 10,000 mm Sheathing material: PUR
	50130676	KD U-M12-4A-P1-100-DP	Connection cable	Connection 1: Connector, M12, Axial, Female, A-coded, 4 -pin Connector, LED: Yes, 1 Piece(s) Connection 2: Open end Shielded: No Cable length: 10,000 mm Sheathing material: PUR

**Part no.: 50135714 – LCS-1M18P-F08NNO-M12 – Capacitive sensor**

	Part no.	Designation	Article	Description
	50130648	KD U-M12-4A-V1-020	Connection cable	Connection 1: Connector, M12, Axial, Female, A-coded, 4 -pin Connection 2: Open end Shielded: No Cable length: 2,000 mm Sheathing material: PVC
	50130652	KD U-M12-4A-V1-050	Connection cable	Connection 1: Connector, M12, Axial, Female, A-coded, 4 -pin Connection 2: Open end Shielded: No Cable length: 5,000 mm Sheathing material: PVC
	50130653	KD U-M12-4A-V1-100	Connection cable	Connection 1: Connector, M12, Axial, Female, A-coded, 4 -pin Connection 2: Open end Shielded: No Cable length: 10,000 mm Sheathing material: PVC
	50132431	KD U-M12-4A-V1-200	Connection cable	Connection 1: Connector, M12, Axial, Female, A-coded, 4 -pin Connection 2: Open end Shielded: No Cable length: 20,000 mm Sheathing material: PVC
	50132430	KD U-M12-4A-V1-300	Connection cable	Connection 1: Connector, M12, Axial, Female, A-coded, 4 -pin Connection 2: Open end Shielded: No Cable length: 30,000 mm Sheathing material: PVC
	50130692	KD U-M12-4W-P1-020	Connection cable	Connection 1: Connector, M12, Angled, Female, A-coded, 4 -pin Connection 2: Open end Shielded: No Cable length: 2,000 mm Sheathing material: PUR
	50130718	KD U-M12-4W-P1-020-DP	Connection cable	Connection 1: Connector, M12, Angled, Female, A-coded, 4 -pin Connector, LED: Yes, 1 Piece(s) Connection 2: Open end Shielded: No Cable length: 2,000 mm Sheathing material: PUR
	50130694	KD U-M12-4W-P1-050	Connection cable	Connection 1: Connector, M12, Angled, Female, A-coded, 4 -pin Connection 2: Open end Shielded: No Cable length: 5,000 mm Sheathing material: PUR
	50130720	KD U-M12-4W-P1-050-DP	Connection cable	Connection 1: Connector, M12, Angled, Female, A-coded, 4 -pin Connector, LED: Yes, 1 Piece(s) Connection 2: Open end Shielded: No Cable length: 5,000 mm Sheathing material: PUR
	50130695	KD U-M12-4W-P1-100	Connection cable	Connection 1: Connector, M12, Angled, Female, A-coded, 4 -pin Connection 2: Open end Shielded: No Cable length: 10,000 mm Sheathing material: PUR

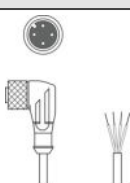
**Part no.: 50135714 – LCS-1M18P-F08NNO-M12 – Capacitive sensor**

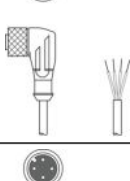
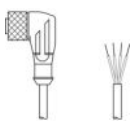
	Part no.	Designation	Article	Description
	50130721	KD U-M12-4W-P1-100-DP	Connection cable	Connection 1: Connector, M12, Angled, Female, A-coded, 4 -pin Connector, LED: Yes, 1 Piece(s) Connection 2: Open end Shielded: No Cable length: 10,000 mm Sheathing material: PUR
	50130688	KD U-M12-4W-V1-020	Connection cable	Connection 1: Connector, M12, Angled, Female, A-coded, 4 -pin Connection 2: Open end Shielded: No Cable length: 2,000 mm Sheathing material: PVC
	50130690	KD U-M12-4W-V1-050	Connection cable	Connection 1: Connector, M12, Angled, Female, A-coded, 4 -pin Connection 2: Open end Shielded: No Cable length: 5,000 mm Sheathing material: PVC
	50130691	KD U-M12-4W-V1-100	Connection cable	Connection 1: Connector, M12, Angled, Female, A-coded, 4 -pin Connection 2: Open end Shielded: No Cable length: 10,000 mm Sheathing material: PVC
	50132641	KD U-M12-4W-V1-200	Connection cable	Connection 1: Connector, M12, Angled, Female, A-coded, 4 -pin Connection 2: Open end Shielded: No Cable length: 20,000 mm Sheathing material: PVC

**Mounting technology - Mounting brackets**

	Part no.	Designation	Article	Description
	50113548	BT D18M.5	Mounting bracket	Diameter, inner: 18 mm Design of mounting device: Angle, L-shape Mounting bracket, at system: Through-hole mounting Mounting bracket, at device: Screw type Type of mounting device: Rigid Material: Stainless steel



**Mounting technology - Rod mounts**

	Part no.	Designation	Article	Description
	50117490	BTU D18M-D12	Mounting system	Design of mounting device: Mounting system Mounting bracket, at system: Through-hole mounting Mounting bracket, at device: Screw type Type of mounting device: Clampable, Adjustable, Turning, 360° Material: Metal



Part no.: 50135714 – LCS-1M18P-F08NNO-M12 – Capacitive sensor

## Mounting technology - Other

	Part no.	Designation	Article	Description
	50132729	AC D18M-CS	Clamp	Contains: 2x M24 mounting nut Diameter, inner: 18 mm Design of mounting device: Mounting clamp Mounting bracket, at system: Screw type, Through-hole mounting Mounting bracket, at device: Insertable, Clampable with limit stop Type of mounting device: Clampable, With limit stop Material: Metal
	50111501	MC 018K	Clamp	Diameter, inner: 18 mm Design of mounting device: Mounting clamp Mounting bracket, at system: Through-hole mounting Mounting bracket, at device: Clampable Type of mounting device: Rigid Material: Plastic
	50111502	MC 018K-LS	Clamp	Diameter, inner: 18 mm Design of mounting device: Mounting clamp Mounting bracket, at system: Through-hole mounting Mounting bracket, at device: Clampable with limit stop Type of mounting device: Rigid Material: Plastic

## Notes

### Observe intended use!

- This product is not a safety sensor and is not intended as personnel protection.
- The product may only be put into operation by competent persons.
- Only use the product in accordance with its intended use.