



Part no.: 50135767
LCS-1M18M-N15PNO-M12
Capacitive sensor



Figure can vary

Contents

- . Technical data
- . Dimensioned drawings
- . Electrical connection
- . Circuit diagrams
- . Operation and display
- . Accessories
- . Notes



Technical data

Basic data	
Series	LCS-1
Switching distance S_n	2 ... 15 mm
Assured switching distance	15 mm

Electrical data	
Protective circuit	Short circuit protected Polarity reversal protection

Performance data	
Supply voltage	10 ... 30 V, DC
Residual ripple	0 ... 10 %, From U_B
Open-circuit current	15 mA
Temperature drift, max. (in % of S_r)	20 %
Repeatability, max. (in % of S_r)	2 %
Rated operating current	100 mA

Outputs	
Number of digital switching outputs	1 Piece(s)

Switching outputs	
Type	Digital switching output
Voltage type	DC

Switching output 1	
Assignment	Connection 1, pin 2
Switching element	Transistor, PNP
Switching principle	NO (normally open)

Timing	
Switching frequency	100 Hz

Connection	
Number of connections	1 Piece(s)

Connection 1	
Type of connection	Connector
Function	Voltage supply Signal OUT
Thread size	M12
Type	Male
Material	Plastic
No. of pins	3 -pin
Encoding	A-coded

Mechanical data	
Design	Cylindrical
Thread size	M18 x 1 mm
Dimension (\varnothing x L)	18 mm x 88.5 mm
Type of installation	Non-embedded
Housing material	Metal Stainless steel, V2A
Sensing face material	Plastic, Polybutylene (PBT)
Cover material	Plastic, Polybutylene (PBT)/polyamide (PA 12)

Part no.: 50135767 – LCS-1M18M-N15PNO-M12 – Capacitive sensor

Net weight	47 g
------------	------

Operation and display

Type of display	LED
Number of LEDs	2 Piece(s)
Switching distance, adjustable	Yes

Environmental data

Ambient temperature, operation	-25 ... 85 °C
--------------------------------	---------------

Certifications

Degree of protection	IP 67
Protection class	III
Certifications	c UL US
Standards applied	IEC 60947-5-2

Correction factors

Acetone	0.75
Acrylic resin	0.1 ... 0.25
Alcohol	0.85
Ammonia	0.7 ... 0.85
Aniline	0.4
Gasoline	0.1
Celluloid	0.15
Liquid chlorine	0.1
Ebonite	0.15
Epoxy resin	0.15 ... 0.35
Crude oil	0.05
Ethanol	0.85
Ethylene glycol	0.93
Freon R22 and 502 (liquid)	0.35
Grain	0.15 ... 0.3
Glass	0.2 ... 0.55
Glycerin	0.98
Rubber	0.15 ... 0.9
Wood, wet	0.6 ... 0.85
Wood, dry	0.1 ... 0.4
Marble	0.5
Flour	0.05
Melamine resin	0.25 ... 0.55
Milk powder	0.2
Nylon	0.2 ... 0.3
Oil-containing paper	0.25
Paper	0.1
Polyamide	0.3
Polyester resin	0.15 ... 0.5
Pressboard	0.1 ... 0.3
PTFE	0.1
Quartz glass	0.2

Part no.: 50135767 – LCS-1M18M-N15PNO-M12 – Capacitive sensor

Salt	0.35
Sand	0.15 ... 0.3
Water	1
Cement dust	0.25
Sugar	0.15

Classification

eCl@ss 8.0	27270102
eCl@ss 9.0	27270102
ETIM 5.0	EC002715

Dimensioned drawings

All dimensions in millimeters

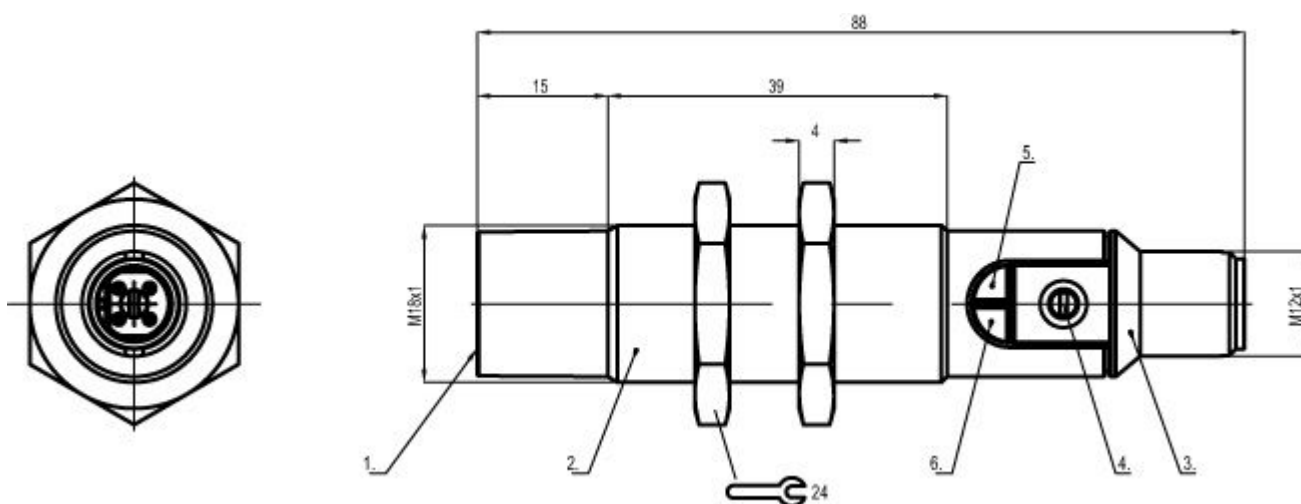

- 1 Active surface
- 2 Housing
- 3 Cover
- 4 Potentiometer
- 5 Green LED, operating voltage display
- 6 Yellow LED, function indicator

Electrical connection

Connection 1	
Type of connection	Connector
Function	Voltage supply Signal OUT
Thread size	M12
Type	Male
Material	Plastic
No. of pins	3 -pin
Encoding	A-coded

Part no.: 50135767 – LCS-1M18M-N15PNO-M12 – Capacitive sensor

Pin	Pin assignment	Conductor color
1	+10...30 V DC	Brown
2	OUT	Black
3	GND	Blue

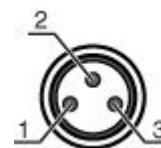

Circuit diagrams

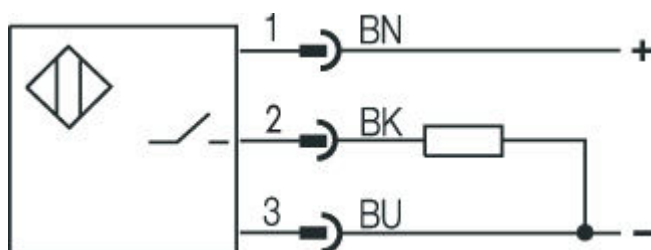



Operation and display

LEDs

LED	Display	Meaning
1	Green, continuous light	Ready
2	Yellow, continuous light	Switching output/switching state

Accessories

Connection technology - Connection cables

	Part no.	Designation	Article	Description
	50112960	K-D M12A-4P-10m-FAB	Connection cable	Connection 1: Connector, M12, Axial, Female, A-coded, 4 -pin Connection 2: Open end Shielded: No Cable length: 10,000 mm Sheathing material: FAB
	50104570	K-D M12A-4P-2m-FAB	Connection cable	Connection 1: Connector, M12, Axial, Female, A-coded, 4 -pin Connection 2: Open end Shielded: No Cable length: 2,000 mm Sheathing material: FAB
	50104572	K-D M12A-4P-5m-FAB	Connection cable	Connection 1: Connector, M12, Axial, Female, A-coded, 4 -pin Connection 2: Open end Shielded: No Cable length: 5,000 mm Sheathing material: FAB



Part no.: 50135767 – LCS-1M18M-N15PNO-M12 – Capacitive sensor

	Part no.	Designation	Article	Description
	50112961	K-D M12W-4P-10m- FAB	Connection cable	Connection 1: Connector, M12, Angled, Female, A-coded, 4 -pin Connection 2: Open end Shielded: No Cable length: 10,000 mm Sheathing material: FAB
	50104571	K-D M12W-4P-2m- FAB	Connection cable	Connection 1: Connector, M12, Angled, Female, A-coded, 4 -pin Connection 2: Open end Shielded: No Cable length: 2,000 mm Sheathing material: FAB
	50104573	K-D M12W-4P-5m- FAB	Connection cable	Connection 1: Connector, M12, Angled, Female, A-coded, 4 -pin Connection 2: Open end Shielded: No Cable length: 5,000 mm Sheathing material: FAB
	50130654	KD U-M12-4A- P1-020	Connection cable	Connection 1: Connector, M12, Axial, Female, A-coded, 4 -pin Connection 2: Open end Shielded: No Cable length: 2,000 mm Sheathing material: PUR
	50130672	KD U-M12-4A- P1-020-DP	Connection cable	Connection 1: Connector, M12, Axial, Female, A-coded, 4 -pin Connector, LED: Yes, 1 Piece(s) Connection 2: Open end Shielded: No Cable length: 2,000 mm Sheathing material: PUR
	50130657	KD U-M12-4A- P1-050	Connection cable	Connection 1: Connector, M12, Axial, Female, A-coded, 4 -pin Connection 2: Open end Shielded: No Cable length: 5,000 mm Sheathing material: PUR
	50130675	KD U-M12-4A- P1-050-DP	Connection cable	Connection 1: Connector, M12, Axial, Female, A-coded, 4 -pin Connector, LED: Yes, 1 Piece(s) Connection 2: Open end Shielded: No Cable length: 5,000 mm Sheathing material: PUR
	50130658	KD U-M12-4A- P1-100	Connection cable	Connection 1: Connector, M12, Axial, Female, A-coded, 4 -pin Connection 2: Open end Shielded: No Cable length: 10,000 mm Sheathing material: PUR
	50130676	KD U-M12-4A- P1-100-DP	Connection cable	Connection 1: Connector, M12, Axial, Female, A-coded, 4 -pin Connector, LED: Yes, 1 Piece(s) Connection 2: Open end Shielded: No Cable length: 10,000 mm Sheathing material: PUR
	50130648	KD U-M12-4A- V1-020	Connection cable	Connection 1: Connector, M12, Axial, Female, A-coded, 4 -pin Connection 2: Open end Shielded: No Cable length: 2,000 mm Sheathing material: PVC

Part no.: 50135767 – LCS-1M18M-N15PNO-M12 – Capacitive sensor

	Part no.	Designation	Article	Description
	50130652	KD U-M12-4A-V1-050	Connection cable	Connection 1: Connector, M12, Axial, Female, A-coded, 4 -pin Connection 2: Open end Shielded: No Cable length: 5,000 mm Sheathing material: PVC
	50130653	KD U-M12-4A-V1-100	Connection cable	Connection 1: Connector, M12, Axial, Female, A-coded, 4 -pin Connection 2: Open end Shielded: No Cable length: 10,000 mm Sheathing material: PVC
	50132431	KD U-M12-4A-V1-200	Connection cable	Connection 1: Connector, M12, Axial, Female, A-coded, 4 -pin Connection 2: Open end Shielded: No Cable length: 20,000 mm Sheathing material: PVC
	50132430	KD U-M12-4A-V1-300	Connection cable	Connection 1: Connector, M12, Axial, Female, A-coded, 4 -pin Connection 2: Open end Shielded: No Cable length: 30,000 mm Sheathing material: PVC
	50130692	KD U-M12-4W-P1-020	Connection cable	Connection 1: Connector, M12, Angled, Female, A-coded, 4 -pin Connection 2: Open end Shielded: No Cable length: 2,000 mm Sheathing material: PUR
	50130718	KD U-M12-4W-P1-020-DP	Connection cable	Connection 1: Connector, M12, Angled, Female, A-coded, 4 -pin Connector, LED: Yes, 1 Piece(s) Connection 2: Open end Shielded: No Cable length: 2,000 mm Sheathing material: PUR
	50130694	KD U-M12-4W-P1-050	Connection cable	Connection 1: Connector, M12, Angled, Female, A-coded, 4 -pin Connection 2: Open end Shielded: No Cable length: 5,000 mm Sheathing material: PUR
	50130720	KD U-M12-4W-P1-050-DP	Connection cable	Connection 1: Connector, M12, Angled, Female, A-coded, 4 -pin Connector, LED: Yes, 1 Piece(s) Connection 2: Open end Shielded: No Cable length: 5,000 mm Sheathing material: PUR
	50130695	KD U-M12-4W-P1-100	Connection cable	Connection 1: Connector, M12, Angled, Female, A-coded, 4 -pin Connection 2: Open end Shielded: No Cable length: 10,000 mm Sheathing material: PUR
	50130721	KD U-M12-4W-P1-100-DP	Connection cable	Connection 1: Connector, M12, Angled, Female, A-coded, 4 -pin Connector, LED: Yes, 1 Piece(s) Connection 2: Open end Shielded: No Cable length: 10,000 mm Sheathing material: PUR

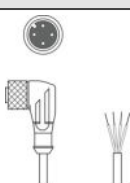
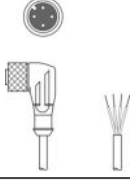
Part no.: 50135767 – LCS-1M18M-N15PNO-M12 – Capacitive sensor

	Part no.	Designation	Article	Description
	50130688	KD U-M12-4W-V1-020	Connection cable	Connection 1: Connector, M12, Angled, Female, A-coded, 4 -pin Connection 2: Open end Shielded: No Cable length: 2,000 mm Sheathing material: PVC
	50130690	KD U-M12-4W-V1-050	Connection cable	Connection 1: Connector, M12, Angled, Female, A-coded, 4 -pin Connection 2: Open end Shielded: No Cable length: 5,000 mm Sheathing material: PVC
	50130691	KD U-M12-4W-V1-100	Connection cable	Connection 1: Connector, M12, Angled, Female, A-coded, 4 -pin Connection 2: Open end Shielded: No Cable length: 10,000 mm Sheathing material: PVC
	50132641	KD U-M12-4W-V1-200	Connection cable	Connection 1: Connector, M12, Angled, Female, A-coded, 4 -pin Connection 2: Open end Shielded: No Cable length: 20,000 mm Sheathing material: PVC

Mounting technology - Mounting brackets

	Part no.	Designation	Article	Description
	50113548	BT D18M.5	Mounting bracket	Diameter, inner: 18 mm Design of mounting device: Angle, L-shape Mounting bracket, at system: Through-hole mounting Mounting bracket, at device: Screw type Type of mounting device: Rigid Material: Stainless steel



Mounting technology - Rod mounts

	Part no.	Designation	Article	Description
	50117490	BTU D18M-D12	Mounting system	Design of mounting device: Mounting system Mounting bracket, at system: Through-hole mounting Mounting bracket, at device: Screw type Type of mounting device: Clampable, Adjustable, Turning, 360° Material: Metal

Mounting technology - Other

	Part no.	Designation	Article	Description
	50132729	AC D18M-CS	Clamp	Contains: 2x M24 mounting nut Diameter, inner: 18 mm Design of mounting device: Mounting clamp Mounting bracket, at system: Screw type, Through-hole mounting Mounting bracket, at device: Insertable, Clampable with limit stop Type of mounting device: Clampable, With limit stop Material: Metal

Part no.: 50135767 – LCS-1M18M-N15PNO-M12 – Capacitive sensor

	Part no.	Designation	Article	Description
	50111501	MC 018K	Clamp	Diameter, inner: 18 mm Design of mounting device: Mounting clamp Mounting bracket, at system: Through-hole mounting Mounting bracket, at device: Clampable Type of mounting device: Rigid Material: Plastic
	50111502	MC 018K-LS	Clamp	Diameter, inner: 18 mm Design of mounting device: Mounting clamp Mounting bracket, at system: Through-hole mounting Mounting bracket, at device: Clampable with limit stop Type of mounting device: Rigid Material: Plastic

Notes

Observe intended use!
<ul style="list-style-type: none"> • This product is not a safety sensor and is not intended as personnel protection. • The product may only be put into operation by competent persons. • Only use the product in accordance with its intended use.