

iVu Plus BCR Gen2 Series Sensor

Instruction Manual

Original Instructions
179047 Rev. C
21 April 2015



179047

Contents

| | |
|---|----|
| 1 Overview of the Sensor | 5 |
| 1.1 Live Mode Overview | 5 |
| 1.1.1 Read/No Read, Pass/Fail, Match/No Match | 5 |
| 1.1.2 Trigger Modes | 5 |
| 1.1.3 Compare Data | 6 |
| 1.1.4 Output 1, Output 2, and Output 3 | 6 |
| 1.1.5 Serial and Ethernet Output | 6 |
| 1.2 Imager Resolution | 7 |
| 2 Installation | 8 |
| 2.1 Components | 8 |
| 2.1.1 iVu with Integrated Display | 8 |
| 2.1.2 iVu with Remote Display | 8 |
| 2.2 Cable Connections | 9 |
| 2.2.1 Cable Connections for Integrated Display | 9 |
| 2.2.2 Cable Connections for Remote Display | 10 |
| 2.2.3 iVu Trigger, Remote Teach, and I/O Waveforms | 11 |
| 2.3 Installing and Connecting the Sensor | 13 |
| 2.3.1 Installing a Filter on iVu Series Sensors | 13 |
| 3 Home Screen | 16 |
| 3.1 Display Modes | 16 |
| 3.1.1 Display/Hide Annotations | 16 |
| 3.1.2 Inspection Statistics | 16 |
| 4 Main Menu Reference | 19 |
| 4.1 Main Menu | 19 |
| 4.1.1 Icon Reference | 19 |
| 4.2 System Menu | 21 |
| 4.2.1 Mode | 22 |
| 4.2.2 System Configuration | 22 |
| 4.2.3 System Information | 23 |
| 4.2.4 Lock device | 24 |
| 4.2.5 Communications | 24 |
| 4.2.6 Discrete I/O | 29 |
| 4.2.7 Display Settings | 31 |
| 4.2.8 Reboot Sensor | 32 |
| 4.2.9 Firmware Update | 32 |
| 4.3 Imager Menu | 33 |
| 4.3.1 Auto Exposure | 33 |
| 4.3.2 Exposure | 33 |
| 4.3.3 Gain | 34 |
| 4.3.4 Trigger | 34 |
| 4.3.5 Focus | 35 |
| 4.3.6 Strobe | 35 |
| 4.3.7 FOV (Field of View) | 36 |
| 4.3.8 Resolution | 37 |
| 4.4 Inspection Menu | 38 |
| 4.4.1 Barcode Menu | 38 |
| 4.4.2 Properties | 43 |
| 4.4.3 Stored Inspections | 44 |
| 4.5 Logs Menu | 45 |
| 4.5.1 Inspection Logs | 45 |
| 4.5.2 System Logs | 47 |
| 4.5.3 Communication Logs | 47 |
| 5 Setting up an Inspection | 48 |
| 5.1 Acquiring a Good Image | 48 |
| 5.1.1 Adjust the Focus on a Micro Video Lens Model | 49 |
| 5.1.2 Adjust the Focus on a C-Mount Lens Model | 49 |
| 5.2 Using iVu Gen1 and Gen2 Devices in the Same Application | 50 |
| 5.3 Setting Up a Barcode Application | 50 |
| 5.4 Setting up for Data Compare | 51 |
| 5.4.1 Remote Teach | 52 |
| 6 Communications Guide | 53 |
| 6.1 Introduction | 53 |
| 6.2 iVu Plus Communication Summary of Ethernet and Serial | 53 |

| | | |
|--------|---|-----|
| 6.2.1 | Communication Channels | 53 |
| 6.2.2 | Industrial Ethernet | 53 |
| 6.2.3 | Command Channel | 54 |
| 6.2.4 | Data Export | 55 |
| 6.2.5 | Image Export | 55 |
| 6.3 | Enabling Communications | 56 |
| 6.3.1 | Setting Up Ethernet Communications | 56 |
| 6.3.2 | Setting Up Serial Communications | 60 |
| 6.4 | Testing and Troubleshooting iVu Plus Communications | 63 |
| 6.4.1 | Understanding the Communication Log | 63 |
| 6.4.2 | Ethernet I/O | 64 |
| 6.4.3 | Serial I/O | 64 |
| 6.5 | Command Channel Primer | 66 |
| 6.5.1 | Command Channel Commands | 66 |
| 6.5.2 | Conventions Used for Examples | 67 |
| 6.5.3 | Examples | 67 |
| 6.5.4 | Command Channel Reference | 69 |
| 6.5.5 | Command Channel Command Status Register | 74 |
| 6.5.6 | Command Channel Error Codes | 74 |
| 6.6 | iVu Discovery Protocol | 75 |
| 6.6.1 | Overview | 75 |
| 6.6.2 | UDP Usage | 75 |
| 6.6.3 | Packet Format | 75 |
| 6.6.4 | Message Flow | 79 |
| 7 | Industrial Ethernet Overview | 83 |
| 7.1 | Device Setup | 83 |
| 7.1.1 | Set IP Address | 83 |
| 7.1.2 | Set Industrial Ethernet Protocol (EIP/Modbus/TCP/PCCC/PROFINET®) | 83 |
| 7.1.3 | Set Trigger Mode | 83 |
| 7.2 | Supported Functions | 83 |
| 7.2.1 | iVu Input Values | 83 |
| 7.2.2 | iVu Output Values | 84 |
| 7.3 | Sensor Operation | 84 |
| 7.3.1 | General Command Execution | 85 |
| 7.4 | EtherNet/IP | 85 |
| 7.4.1 | Inputs to iVu (Outputs from PLC) | 86 |
| 7.4.2 | Outputs from the iVu (Inputs to the PLC) | 86 |
| 7.4.3 | Input and Output Flags Bits | 89 |
| 7.4.4 | Configuration Assembly Object | 89 |
| 7.4.5 | Data Formats | 89 |
| 7.4.6 | Minimum Requested Packet Interval (RPI) Value | 90 |
| 7.4.7 | iVu Plus EDS File Installation in ControlLogix Software | 90 |
| 7.4.8 | RSLogix5000 Configuration | 96 |
| 7.5 | Modbus/TCP | 103 |
| 7.5.1 | iVu Plus Input Values | 105 |
| 7.5.2 | iVu Plus Output Values | 105 |
| 7.5.3 | Flags | 107 |
| 7.6 | PLC5 and SLC 5 (PCCC) | 108 |
| 7.6.1 | Configuration | 108 |
| 7.6.2 | Inputs to iVu (Outputs from PLC) | 110 |
| 7.6.3 | Outputs from iVu (Inputs to PLC) | 110 |
| 7.6.4 | Input and Output Flags | 112 |
| 7.7 | PROFINET | 113 |
| 7.7.1 | General Station Description (GSD) File | 113 |
| 7.7.2 | iVu PROFINET IO Data Model | 113 |
| 7.7.3 | Configuration Instructions | 129 |
| 7.8 | Sample Timing Diagram | 151 |
| 7.9 | Command Channel Command Status Register | 154 |
| 7.10 | Diagnostic Guide | 154 |
| 7.10.1 | Ethernet Diagnostics | 154 |
| 7.10.2 | Networking and TCP/IP Diagnostics | 155 |
| 7.10.3 | Industrial Protocols Troubleshooting | 157 |
| 7.11 | Additional Information | 165 |
| 7.11.1 | iVu Command Channel Commands (iVu Command Channel over Industrial EtherNet) | 165 |
| 8 | Debugging Inspections | 170 |
| 8.1 | iVu Emulator | 170 |
| 8.2 | How to Round-Trip Debug Using the Emulator | 170 |
| 8.2.1 | How to Debug Using the Emulator from a PC | 170 |
| 8.2.2 | How to Debug Using the Emulator from the USB Flash Drive | 171 |
| 9 | Updating the Sensor | 172 |

| | |
|---|------------|
| 9.1 Update Process | 172 |
| 9.2 How to Set or Modify a Device Name using the Emulator | 172 |
| 9.3 How to Reset the Sensor Password | 173 |
| 9.4 How to Use Bitmap Image Files with the iVu Emulator | 173 |
| 10 LED Indicator Troubleshooting | 175 |
| 10.1 Errors | 175 |
| 10.2 Warnings | 175 |
| 11 Product Support and Maintenance | 176 |
| 11.1 Product Support | 176 |
| 11.2 Maintenance | 176 |
| 11.3 Contact Us | 177 |
| 11.4 Banner Engineering Corp Limited Warranty | 178 |

1 Overview of the Sensor

The iVu Plus BCR sensor reads a wide variety of barcodes. The package consists of sensor, lighting, lens, and display. Cables and mounting brackets can be ordered for each application. Additionally, other lenses, filters, and external lights are available. Installation, setup, and configuration can be done quickly without requiring a PC.

- No PC required to configure the sensor
- USB port for uploading and downloading of inspections and log files for easy updating and diagnostics
- Image processing expertise is not required
- Integrated or remote color touch screen display
- High speed processing

The iVu Plus BCR reads the following barcode types:

- DataMatrix (ECC 200) barcodes
- QR Code (QR and Micro QR)
- Linear barcodes: Code128, Code39, CODABAR, Interleaved 2 of 5, EAN13, EAN8, UPCE, Postnet, IMB, and Pharmacode

1.1 Live Mode Overview

The iVu Plus BCR can be configured to evaluate one or more of the supported barcode types and can look for a specific number of barcodes from 1 to 10. The barcode types are selected on the integrated touch screen by accessing Main Menu > Inspection > Barcode > Barcode Type. The barcode count is selected on the touch screen by going to Main Menu > Inspection > Barcode > Barcode Count.

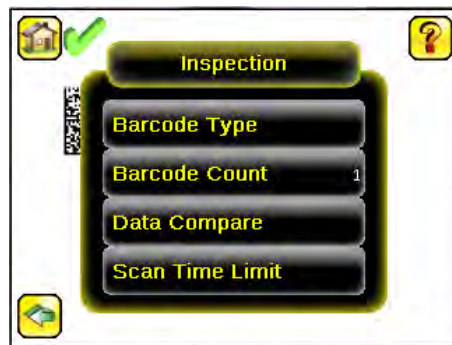

1.1.1 Read/No Read, Pass/Fail, Match/No Match

- A Read condition occurs when the configured number of barcodes are found in a scan. These barcodes must be error-free.
- A No Read condition occurs when the configured number of barcodes are not found in a scan.
- If the sensor is configured where Data Compare is disabled, Pass and Fail are the same as Read and No Read.
- If the sensor is using the Data Compare feature, Pass indicates that a good barcode was found and the data compared.
- If the sensor is using the Data Compare feature, Fail indicates that either no good barcode was found or the data did not compare.
- A Match condition occurs when the required number of barcodes are found and the compare is successful.
- A No Match condition occurs when the required number of barcodes are found, but the compare is not successful.

1.1.2 Trigger Modes

The iVu Plus BCR has five trigger modes that determine how the sensor captures and processes images:

- External-Single
- Continuous
- External-Gated
- Command
- Industrial Ethernet Only

You can select one of the trigger modes by accessing Main Menu > Imager > Trigger on the iVu touch screen display. [Trigger](#) on page 34 describes these trigger modes in more detail.

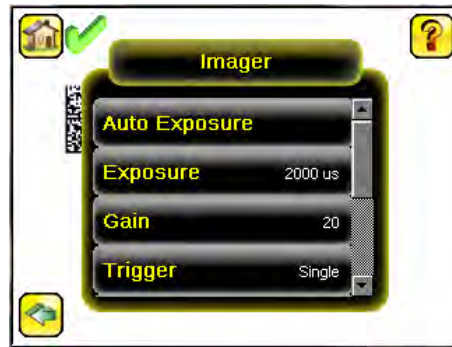

1.1.3 Compare Data

The iVu Plus BCR has a data compare feature for comparing read barcode data against reference data. Data can be manually entered by navigating to the Main Menu > Inspection > Barcode > Data Compare > Set Data screen. Data of up to 3200 characters can be entered. Additionally, the data compare feature provides for masking characters within the data.

There are two other ways to enter compare data:

- Importing the last read data while viewing the Set Data screen. The new data is effective on the first trigger that occurs after this action.
- Using Remote Teach.

When a Remote Teach occurs, the data of the first read barcode is saved as Data Compare input. Inspections executed on the next trigger uses the new data for comparison with subsequently read barcodes. If the previous input data contained any masked characters, Remote Teach retains the masked characters only if the new data is of the same length as the previous input data. If the length does not match, masking is removed.

The sensor tries to compare full length of this string with the data read from the barcode. If not equal, the inspection is marked as Fail.



NOTE: If the sensor reads more than one barcode in the field of view, only the first barcode data that the sensor reads can be compared.

1.1.4 Output 1, Output 2, and Output 3

The sensor has three output signals that you can configure for Pass, Fail, Read, No Read, Match, No Match, System Error, and Missed Trigger. The default settings are Pass for Output 1, Fail for Output 2, and Pass for Output 3.



NOTE: For all outputs, the default setting is Latched, which means that the signal is active until the results of an inspection cause a change in the signal output. If Pulsed is selected, the default pulse width is 50 ms.

1.1.5 Serial and Ethernet Output

The iVu Plus communicates with other devices via Ethernet or a UART serial communications port (RS-232). In order to establish an Ethernet connection to the sensor, the external device must be configured with the correct IP address and TCP port to communicate. To use the serial communications connection, port settings for baud rate, data bits, parity, and stop bits must be configured on the iVu Plus to match the settings of the external device.

The iVu Plus BCR RS-232 port or ethernet port can be used to output barcode data to other applications. To access the Data Export screen, go to Main Menu > System > Communications > Data Export. The user can enable or disable this feature. When enabled:

- if the sensor is configured for either External-Single or External-Gated trigger modes, every trigger results in the transmission of output data (if the sensor does not successfully read a barcode, the output will be NO_READ).
- if the sensor is configured for Continuous trigger mode, the sensor transmits output barcode data only upon a successful read.

To access the Serial Output screen, go to Main Menu > System > Communications > Serial I/O.

When RS-232 serial output is enabled, the user can configure:

- Serial Port Settings (listed below)
- Type of Data to Export (listed below)

- Output Format (listed below)

To access the Ethernet Output screen, go to Main Menu > System > Communications > Ethernet I/O.

When ethernet output is enabled, the user can configure:

- IP Address, Port number, Subnet Mask, and Gateway
- Type of Data to Export (listed below)
- Output Format (listed below)

Type of Data to Export:

- Pass/Fail Output
- Inspection Name
- Barcode Count
- Data Length
- Symbol Type
- Barcode Data
- Frame Number
- Inspection Time (ms)

Serial Port Settings:

- Baud Rates
- Start Bits
- Stop Bits
- Data Bits
- Parity Control

Output Format:

- Start String
- Delimiter
- End String

1.2 Imager Resolution

The iVu Plus Barcode Reader (BCR) Gen2 Series Sensor includes an adjustable resolution up to 752×480 pixels.

2 Installation

2.1 Components

2.1.1 iVu with Integrated Display

The iVu Series sensor comes fully assembled with the lens and an integrated ring light if so ordered. The integrated touchscreen display has a plastic cover to protect the display. Remove this cover when setting up the sensor. When the display is not in use be sure to keep the display covered to protect it.

If an integrated ring light is not used, another light source is needed. Various lights are available from Banner. Operating in external trigger mode requires a triggering source (for example, the Banner WORLD-BEAM® QS18VN6D sensor).



- 1 LED - Green: Ready; Red: Error
- 2 LED - Green: Pass; Red: Fail
- 3 Ethernet I/O LED
- 4 Focusing Window
- 5 Focusing Window Locking Clip
- 6 Integrated Display

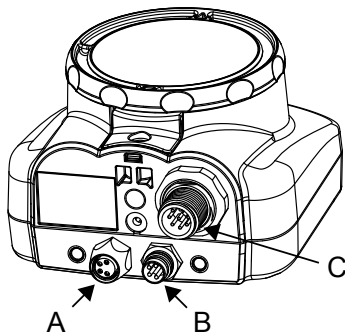

- A 8-pin Euro-style (M12) female USB Cable Connector
- B I/O Cable Connector
- C 12-pin Euro-style (M12) male Power and I/O Cable Connector

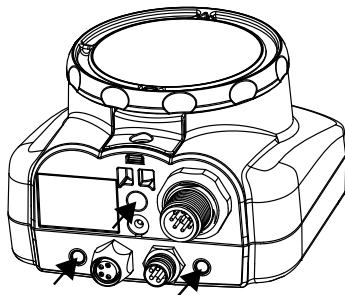

Mounting Bracket Mounting Holes (uses supplied three M4 x 4 mm screws)

2.1.2 iVu with Remote Display

The iVu sensor for use with a Remote Display comes fully assembled with the lens and an integrated ring light if so ordered. Although the Remote Display is not required for normal sensor operation, it is needed to set up the sensor and to monitor inspections.

If an integrated ring light is not used, another light source is needed. Various lights are available from Banner. Operating in external trigger mode requires a triggering source (for example, the Banner WORLD-BEAM® QS18VN6D sensor).



- 1 LED - Green: Ready; Red: Error
- 2 LED - Green: Pass; Red: Fail
- 3 Ethernet I/O LED
- 4 Focusing Window
- 5 Focusing Window Locking Clip

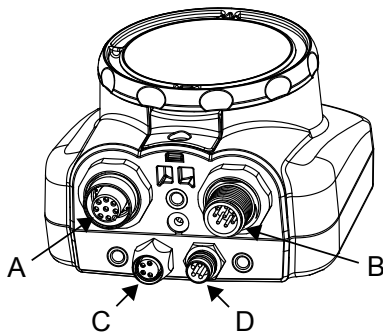

- A Remote Display connector
- B Power and I/O Cable connector
- C USB connector
- D Ethernet connector

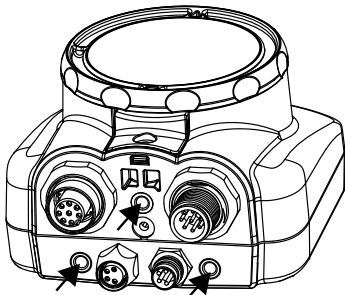

Mounting Bracket Mounting Holes (uses supplied three M4 x 4 mm screws)

2.2 Cable Connections

2.2.1 Cable Connections for Integrated Display

The cable connections on the iVu Plus with integrated display are shown below, and power I/O connections (C) are defined in the Power I/O Connections table below.

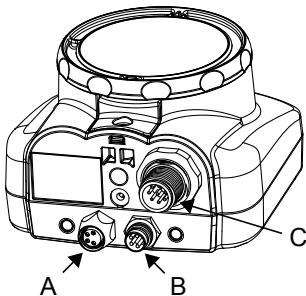

- A USB Connector
- B Ethernet Connector
- C Power I/O Connector



NOTE: Micro video lens model shown, C-Mount model connections are identical.

| Power I/O Connections | | | |
|-----------------------|------------|-------------------------|-----------|
| Pin # | Wire Color | Description | Direction |
| 1 | White | Output 1 | Output |
| 2 | Brown | 10-30V dc | Input |
| 3 | Green | Output 2 | Output |
| 4 | Yellow | Strobe Out (5V dc only) | Output |
| 5 | Gray | Remote Teach | Input |
| 6 | Pink | External Trigger | Input |
| 7 | Blue | Common (Signal Ground) | Input |
| 8 | Red | Ready | Output |
| 9 | Orange | Output 3 | Output |
| 10 | Light Blue | RS-232 TX | Output |
| 11 | Black | RS-232 Signal Ground | Output |
| 12 | Violet | RS-232 Rx | Input |

2.2.2 Cable Connections for Remote Display

The cable connections on the iVu Plus with remote display are shown below, and power I/O connections (B) are defined in the Power I/O Connections table below.

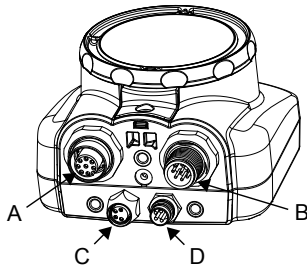

- A Remote Display Connector
- B Power I/O Connector
- C USB Connector
- D Ethernet Connector



NOTE: Micro video lens model shown, C-Mount model connections are identical.

| Power I/O Connections | | | |
|-----------------------|------------|-------------------------|-----------|
| Pin # | Wire Color | Description | Direction |
| 1 | White | Output 1 | Output |
| 2 | Brown | 10-30V dc | Input |
| 3 | Green | Output 2 | Output |
| 4 | Yellow | Strobe Out (5V dc only) | Output |
| 5 | Gray | Remote Teach | Input |
| 6 | Pink | External Trigger | Input |
| 7 | Blue | Common (Signal Ground) | Input |
| 8 | Red | Ready | Output |
| 9 | Orange | Output 3 | Output |
| 10 | Light Blue | RS-232 TX | Output |
| 11 | Black | RS-232 Signal Ground | Output |
| 12 | Violet | RS-232 Rx | Input |

2.2.3 iVu Trigger, Remote Teach, and I/O Waveforms

The iVu has two input signals—Trigger and Remote Teach. The default setting is to detect the low to high transition. This setting can be changed in the Main Menu > System > Discrete I/O > Input Polarity screen on the sensor.

PNP (Low-to-High) Trigger and Remote Teach Input Waveforms

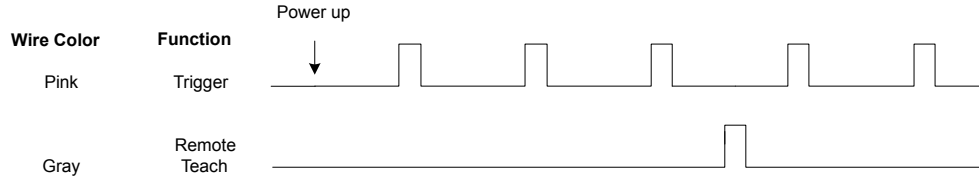

The sensor triggers from low to high, and Remote Teach behaves electrically like trigger.



NOTE:

Table 1: Required iVu Input Signal Voltage

| | ON | OFF |
|-----|----------------|----------|
| PNP | +10 to 30 V dc | < 2 V dc |

NPN (High-to-Low) Trigger and Remote Teach Input Waveforms

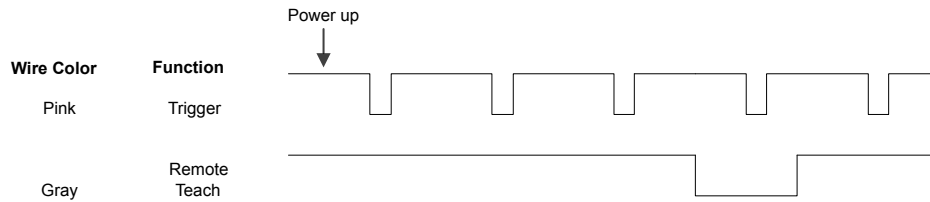

The sensor triggers from high to low, and Remote Teach behaves electrically like trigger.



NOTE:

Table 2: Required iVu Input Signal Voltage

| | ON | OFF |
|-----|----------|----------------|
| NPN | < 2 V dc | +10 to 30 V dc |



NOTE: If the device used to trigger or remote teach the iVu Plus BCR is a sinking device, these are the options regarding the use of a pull-up resistor:

Option 1: Put a pull-up resistor, rated approximately 1k ohm, between the sensor's positive (+) voltage and the sensor's input as shown below.

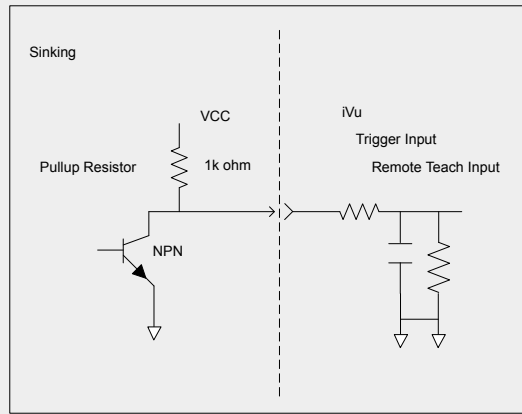

Option 2: Enable the Input Pullup in the iVu Plus BCR software (Main Menu > System > Discrete I/O > Input Pullup).

iVu Output Waveforms

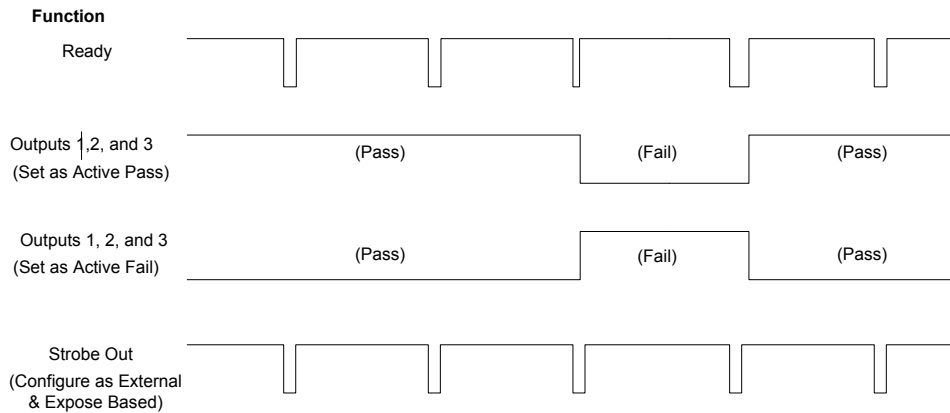

Figure 1. PNP Outputs

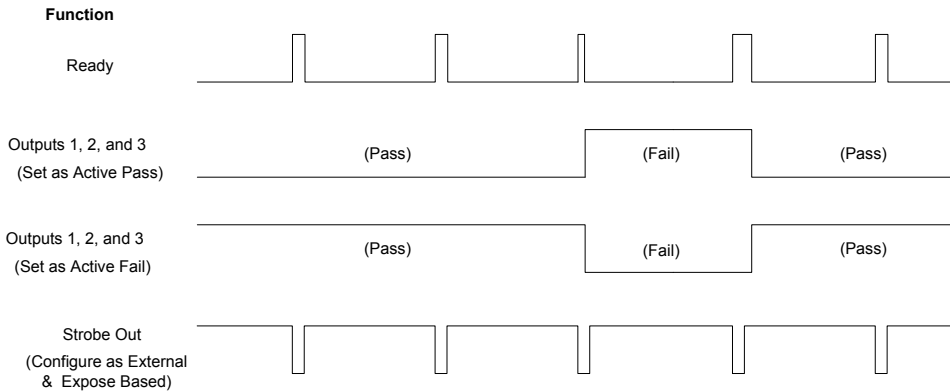

Figure 2. NPN Outputs



NOTE:

Table 3: Expected iVu Output Signal Voltage

| | ON | OFF |
|-----|------|-----|
| PNP | + V | 0 V |
| NPN | +1 V | +V |

2.3 Installing and Connecting the Sensor

The iVu Plus BCR sensor requires a bracket for mounting. Three brackets are available from Banner. The brackets allow the sensor to be mounted either perpendicular to the part or at an adjustable angle.

Thread three M4 x 4mm screws through the bracket into the mounting holes in the bottom of the sensor. Tighten all three screws.

Table 4: iVu Brackets

| SMBIVURAL | SMBIVURAR | SMBIVUU |
|---|---|---|
|  |  |  |

2.3.1 Installing a Filter on iVu Series Sensors

Installing a Filter on the Micro Video Lens Model

To install a filter on the iVu Series sensor with Micro Video Lens, use the illustration as a guide and follow the steps listed below.



CAUTION: Failure to follow these instructions may cause damage to your iVu Series sensor.

| Micro Video Lens Models | |
|---|-------------------|
|  | A Lens |
| | B Focusing Window |
| | C Locking Clip |
| | D Locking Screw |
| | E Filter Cap |
| | F Filter |

1. Remove the Focusing Window locking screw (D) using the 1/16 in. hex key.



NOTE: The Locking Clip (C) inserts in a groove near the top of the Focusing Window (B). When removing the window, the Locking Clip will be loose. Be careful not to lose the clip while removing the window.

2. Unscrew the Focusing Window by turning it clockwise approximately 5 complete turns or until the Focusing Window disengages from the light/lens assembly.



NOTE: The light/lens assembly may include an integrated ring light or a blank disk if an integrated ring light is not used. Be careful that the light/lens assembly does not pull out when removing the Focusing Window. Give a slight tug on the Focusing Window when you think you've unscrewed it far enough. If the lens assembly moves with the window, continue to rotate the window clockwise until the lens assembly does not move.

3. Set the Focusing Window aside. Be careful not to get any debris on the window's O-ring.
4. If present, remove the protective covering on the filter.
5. Place the filter into the Filter Cap and press the cap onto the lens.
6. After the filter is installed, place the Focusing Window back into the housing while inserting the Locking Clip into the groove as shown.

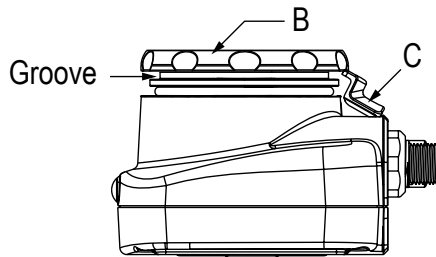

7. Press the Focusing Window onto the housing to make sure that it seats correctly (no gap between the window and housing). Rotate the window counter-clockwise at least two turns.
8. Replace the locking tab screw but do not tighten until you have set up and focused the sensor again.

Installing a Filter on the C-Mount Lens Model

To install a filter on the iVu Series sensor with C-Mount Lens, use the illustration as a guide and follow the steps listed below.



CAUTION: Failure to follow these instructions may cause damage to your iVu Series sensor.

| C-Mount Lens Models | |
|---------------------|---|
| | A C-Mount Lens |
| | B Lens Enclosure |
| | C Retainer Ring (optional) |
| | D Filter (optional) |
| | E Filter Retainer Ring Tool |
| | NOTE: Filter Kits are available separately. |

1. Remove the Lens Enclosure and Lens.
2. Install filter behind the retainer ring. Make sure it is fully seated.
3. Using the provided retainer ring tool, thread the retainer ring into the sensor until it firmly seats the filter.
4. Replace the Lens and Lens Enclosure on the camera.



CAUTION: Electrostatic Discharge

Avoid the damage that electrostatic discharge (ESD) can cause to the Sensor.

Always use a proven method for preventing electrostatic discharge when installing a lens or attaching a cable.

3 Home Screen

The Home screen on the iVu Series sensor display is used to monitor inspections and to configure the sensor. Normally, the part being inspected is centered on the screen.

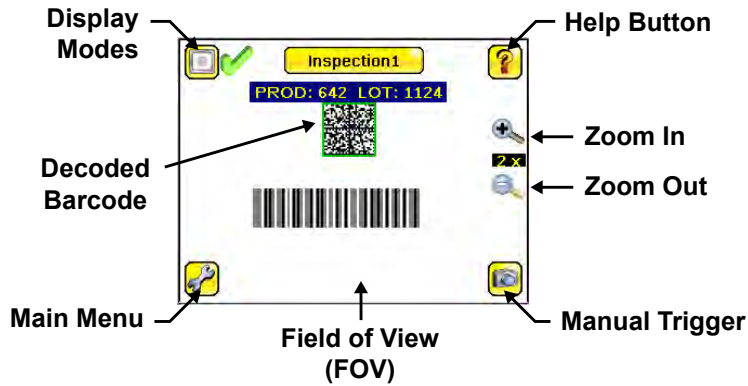

3.1 Display Modes

In the upper left of the screen is an icon for accessing different Display Modes:

- Display Annotations
- Hide Annotations
- Display Statistics.

3.1.1 Display/Hide Annotations

Click the icon in the upper-left of the screen to display annotations. When annotations are on, the display shows the data the sensor has read.

If the sensor reads more than one barcode in the field of view (FOV), in addition to the read data, the display indicates the index of each read barcode. In the example below, the top barcode is 1 and the bottom barcode is 2. It is important to note that, if the sensor reads more than one barcode, only the first barcode data (index #1) can be compared or used in a remote teach operation

Click the icon in the upper-left of the screen to hide annotations.

3.1.2 Inspection Statistics

To access the Inspection Statistics, click the Display mode icon .

The Inspection Statistic mode has three pages:

- History
- Inspection Result
- Inspection Inputs

Click the arrows to access the other pages.

Inspection Results

The Inspection Result screen shows data about the current inspection being viewed, including the

- Barcode (BCR) Pass and Fail count
- Count of barcodes found in current image
- Data for each barcode found
- Execution time of Barcode sensor
- Frame Number (total number of objects since bootup)
- Execution time of entire inspection



Barcode Viewer

To view detailed information about a particular barcode, click the arrow next to the Barcode # to access the Barcode Viewer screen.

If Data Compare is disabled, The Barcode Viewer screen shows a single text box indicating the index number of the barcode and the data the sensor is reading. The data is displayed in yellow.



If Data Compare is enabled and the barcode is the first one, there are two text boxes. The upper one displays the data read from the barcode, and the lower text box shows the data from the Data Compare screen. The sensor does a position-by-position match and the characters that match are in yellow and mismatches are in red.

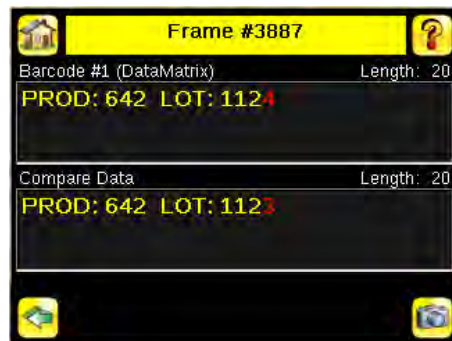

History

The History screen shows inspection history from sensor reboot, or the last time the statistics were reset, including:

- Total count barcode (BCR) sensor Passed and Failed
- Count Range for barcodes found when running this inspection
- Execution Time Range for Barcode sensor
- Pass and Fail count for this inspection (for example, Inspection1)
- Total Frames (images) captured for this inspection
- Missed triggers

Click the Reset button to reset statistics.

The table contains history of each sensor in the inspection. Data of each sensor can be expanded or collapsed as required using the +/- . The green area indicates the sensor passed, red indicates fail. If a sensor fails, an icon besides the sensor name will indicate the reason of failure.

Inspection Inputs

The Inspection Input page has the sensor settings. Use this page to verify what inspection input settings were used on the latest inspection. Click + to expand the inspection information, or - to collapse the inspection information. Use the right arrows as a shortcut to a sensor setting screen.

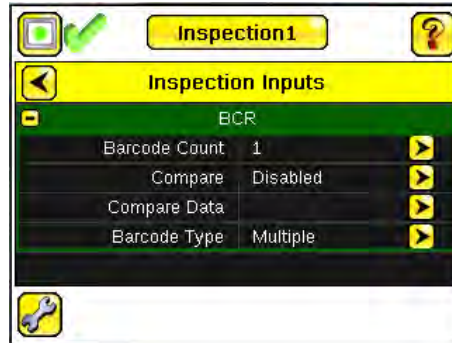

4 Main Menu Reference

4.1 Main Menu

The Main Menu has four sections:



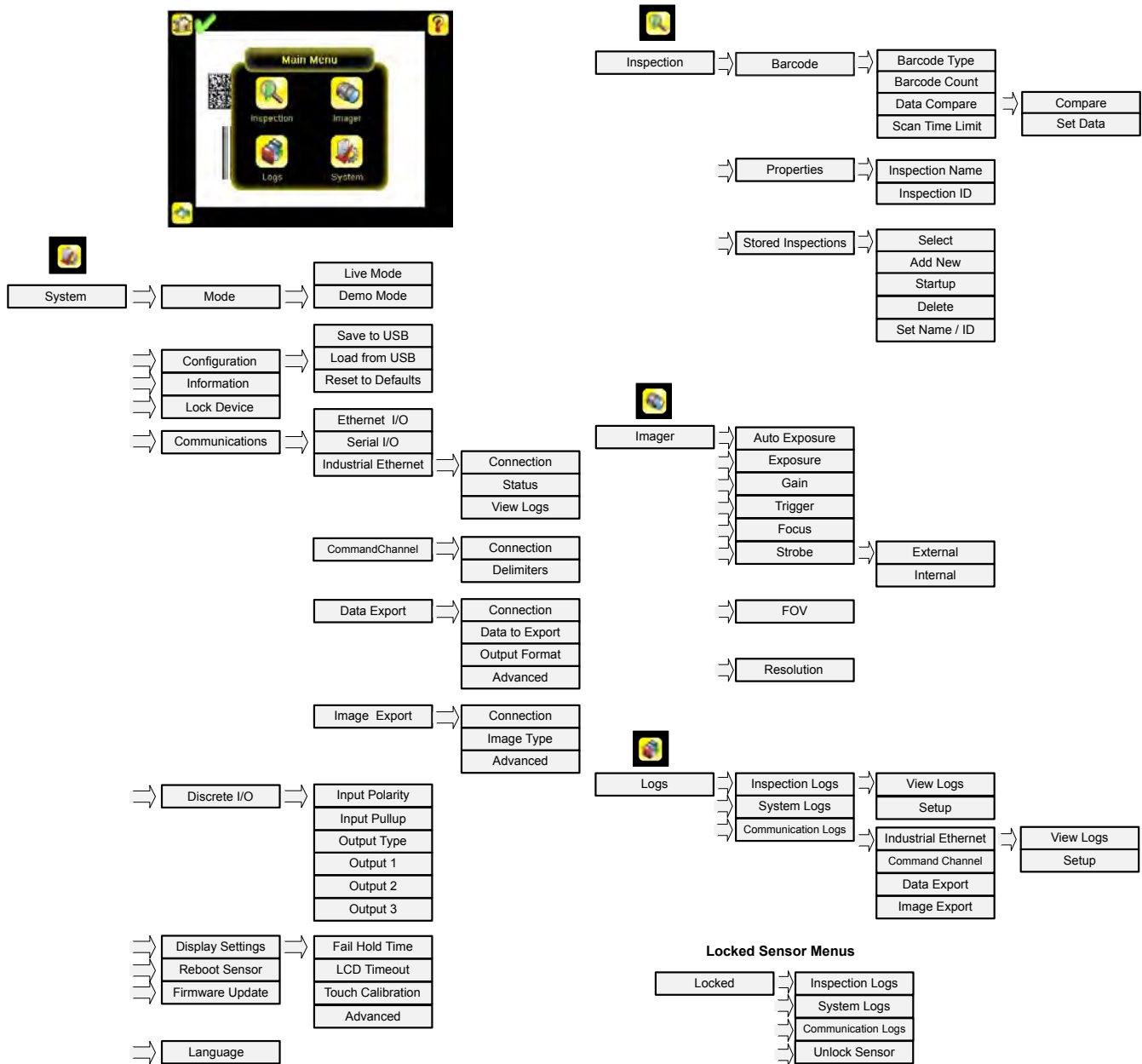















- Inspection—to modify inspection settings
- Imager—to run the Auto Exposure routine and to make adjustments to functions like exposure, gain, and strobe
- System—to set output signals, communication channel parameters and to manage the device
- Logs—to configure and view System and Inspection Logs





4.1.1 Icon Reference







Action Icons

| Icon | Description |
|---|---|
|  | The Main Menu icon is displayed on the bottom-left corner of the sensor display on the Home screen. It provides access to sub-menus that are used to set up the sensor. |







| Icon | Description |
|---|---|
|  | The Inspection menu icon is located on the the Main Menu, and provides access to parameters that need to be set for an inspection. |
|  | The Imager menu icon is on the Main Menu, and lists parameters that affect the characteristics of the captured image. |
|  | The System menu icon is on the Main Menu, and is used to manage the sensor. |
|  | The Logs menu icon is on the Main Menu, and is used to set up, view, and save Inspection and System Logs. |
|  | The Home Screen icon is displayed in the upper-left corner of the sensor display when viewing menus and parameter screens in the Main Menu. It is used to quickly return to the Home Screen. |
|  | The Display Annotations icon is one of three icons displayed in the upper-left corner of the sensor while monitoring inspections on the Home Screen. Click this icon to highlight features that the sensor finds. |
|  | The Hide Annotations icon is one of three icons displayed in the upper-left corner of the sensor while monitoring inspections on the Home Screen. Click this icon to disable highlighting. |
|  | The Show Statistics icon is one of three icons displayed in the upper-left corner of the sensor while monitoring inspections. Click this icon to show inspection results and input parameters. |
|  | The Hide System Log Details icon is one of the icons displayed in the upper-left corner of the System Logs screen. Click this icon to hide the time stamp for the System Logs. |
|  | The Show System Log Details icon is one of the icons displayed in the upper-left corner of the System Logs screen. Click this icon to show the time stamp for the System Logs. |
|  | The Go Back icon is located on the lower-left of the screen while working in the Main Menu. The Go Back icon is used to return to the previous screen or menu. |
|  | The Help button is located in the upper-right of the screen and provides context-sensitive help for each screen. |
|  | The Manual Trigger icon is located on the lower-right of the sensor display on the Home screen and is used to manually capture a new image. |
|  | The Save icon is used to save data to USB drive, and is available at the bottom of screens such as the View Logs and System Logs screens. |
|  | The Touch Calibration screen displays the Touch Calibration point at various locations on the screen. Every time the icon displays, the user taps the center of the icon to calibrate the screen. |
|  | The Zoom Out icon is located on the right of the screen and is used to reduce magnification of the image being displayed. |
|  | The Zoom In icon is located on the right of the screen and is used to magnify the image being displayed. |
|  | The Decrement icon decreases the currently displayed parameter value by one interval. To quickly decrement the value, keep pressing the icon. |
|  | The Increment icon increases the currently displayed parameter value by one interval. To quickly increment the value, keep pressing the icon. |

Display Icons

| Icon | Description |
|---|---|
|  | The Inspection Passed icon is located in the upper-left of the screen, and indicates that the last inspection passed its test conditions. |
|  | One of the possible Inspection Failed icons located in the upper-left of the screen, it indicates that the last inspection failed. |

| Icon | Description |
|---|--|
|  | In either External - Single or External Gated trigger mode this is one of the possible Inspection Failed icons located in the upper-left of the screen. It indicates that the inspection failed because there were fewer barcodes than specified by the Barcode Count. |
|  | In Continuous Scan mode this icon appears in the upper-left of the screen, and indicates that the sensor is still scanning the captured image and hasn't yet found the number of barcodes specified by the Barcode Count. |
|  | In External - Single trigger mode, this is one of the possible Inspection Failed icons located in the upper-left of the screen, it indicates that the inspection failed because the inspection timed out based on the Scan Time Limit value. |
|  | In Continuous Scan or External - Gated trigger mode, this icon appears in the upper-left of the screen, and indicates a busy timeout; that is, the scan timed out based on the Scan Time Limit, but the outputs are not affected. |
|  | One of the possible Inspection Failed icons located in the upper-left of the screen, it indicates that the sensor is in fail hold mode. |
|  | One of the possible Inspection Failed icons located in the upper-left of the screen, it indicates that the data compare has failed for the barcode that the sensor read. |
|  | The Sensor Locked icon is located in the upper-left of the screen, and indicates that the sensor is in a locked state. If no icon is displayed, the sensor is unlocked. |

Communications Log Icons

| Icon | Description |
|---|--|
|  | Port opened. |
|  | Port closed. |
|  | Indicates that the command has been processed without errors. |
|  | Indicates that the incoming entry is stalled (no new bytes), or end-of-frame delimiter was not received, or client is not reading data on ethernet. |
|  | If the response frame contains an error or is dropped, the log entry icons for the request and the response frames will be colored red, and the displayed error count will increment by one. |
|  | If the command takes a long time to process, the last long entry will change to an hourglass (for example, during trigger of long inspections). |

4.2 System Menu

Main Menu > System

The System menu icon is on the Main Menu, and is used to manage the sensor. The System menu provides for selecting Sensor Mode, updating sensor firmware, backing up and restoring sensor Configuration, and other general system-level operations.

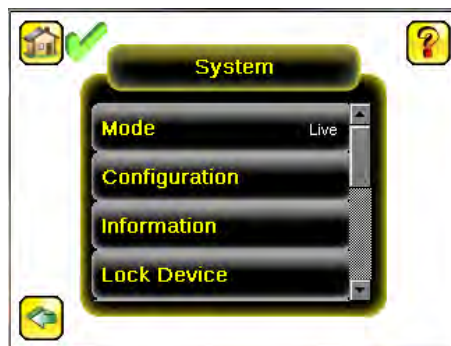

4.2.1 Mode

Main Menu > System > Mode

The sensor has two operating modes:

- Live Mode, which is the normal operating mode where the sensor captures live images, scans, and verifies barcodes
- Demo Mode, where inspections are run on stored images and inspection parameters.

The first time the device is powered up it starts in Demo Mode and allows you to choose whether to stay in Demo Mode or exit to Live Mode.

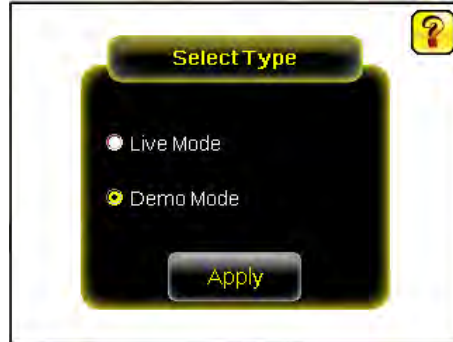

Demo Mode uses stored images and inspection parameters that demonstrate how the sensor is set up without having to worry about focus, lighting, or triggers. In this mode, practice making adjustments while observing how the adjustments affect the results. To exit Demo Mode go to Main Menu > System > Mode and select Exit Demo Mode. Upon exit, the sensor reboots into its normal operating mode with default settings.

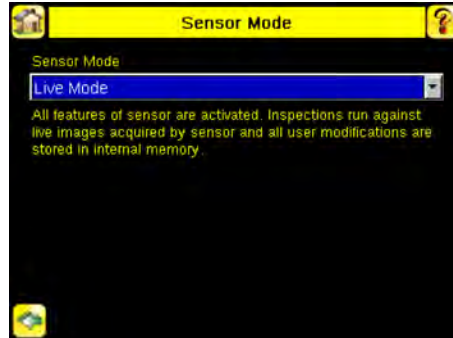

NOTE: Switch between Live Mode and Demo Mode any time by going to Main Menu > System > Mode.

4.2.2 System Configuration

Main Menu > System > Configuration

The Configuration menu options are:

- Save sensor Configuration to the USB flash drive
- Load sensor Configuration from the USB flash drive
- Reset the sensor Configuration to defaults

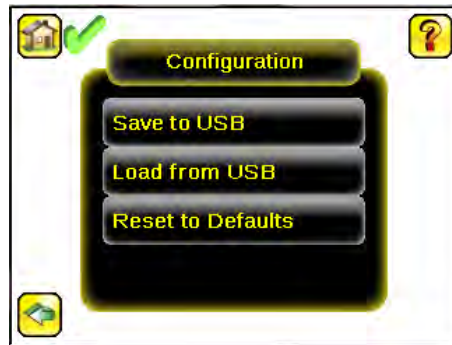

Save to USB

Main Menu > System > Configuration > Save to USB

The Save to USB screen allows the sensor Configuration to be saved to a USB flash drive. The saved configuration information can be used as a backup or as a way to clone configuration information for other sensors.



NOTE: On the Emulator, this option is Save Configuration.

Load from USB

Main Menu > System > Configuration > Load from USB

The Load from USB screen allows the sensor Configuration to be restored from a USB flash drive. This operation removes all existing inspections and replaces them with inspections contained in the configuration file on the USB flash drive.



NOTE: On the Emulator, this option is Load Configuration.

Reset to Defaults

Main Menu > System > Configuration > Reset to Defaults

Resets all sensor configurations to the factory defaults. This operation will remove all existing inspections and replace them with factory default settings.

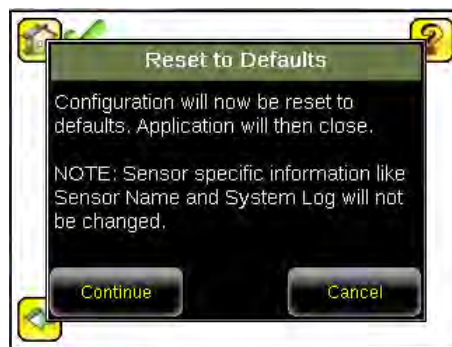

4.2.3 System Information

Main Menu > System > Information

The Information screen displays the following sensor information:

- Serial Number
- Firmware Version
- Boot Number
- Up Timer—the time elapsed since last boot of the sensor
- Hour Count—the total hours of operation in the sensor's lifetime

- Model Number
- Device Name

Click the right-arrow next to the Sensor Name field to display a software keyboard that allows you to change the Sensor Name.

4.2.4 Lock device

Main Menu > System > Lock device

This option provides for locking the sensor to prevent accidental modification of settings. When locked, the sensor only provides access to pass/fail statistics, as well as the ability to view logs and to save them to a USB device. A lock icon in the upper left corner of the sensor display indicates that the sensor is locked. Note that the sensor can be locked with or without a password. If a password is not used, unlock the sensor by clicking on the Unlock device menu. When a password is used, it must be 4 digits entered using the software keypad. If the password is lost, use the Password Reset Utility software provided on the CD to obtain a Reset Key.



NOTE: This menu option is not available in the Emulator.

4.2.5 Communications

Main Menu > System > Communications

The Communications menu is used to configure the serial I/O channel. There are six menu options:

- Ethernet I/O for configuring the Ethernet port
- Serial I/O for configuring the Serial port
- Industrial Ethernet settings
- Command Channel for sending commands to get specific data through Serial or Ethernet channels.
- Data Export Channel for enabling or disabling the channel for data export only
- Image Export Channel for enabling or disabling the channel for image export only



NOTE: Serial I/O can be configured either for Data Export or Command Channel. Image Export is only available on Ethernet.

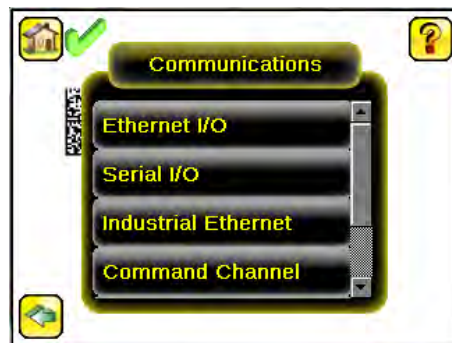

Ethernet I/O

Main Menu > System > Communications > Ethernet I/O

The sensor's Ethernet communications can be used to send data out the Ethernet port as part of an inspection, and remote devices can communicate with the sensor. The Ethernet I/O screen is where IP Address, Subnet Mask, and Gateway settings are configured. Use the expand arrow next to each field to display a software keypad to enter values for each field. Click Status at the bottom of the screen to verify communications as you connect to remote devices.

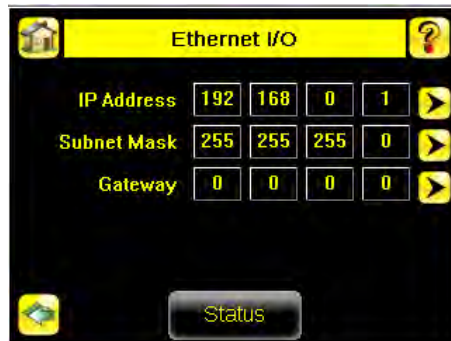

Ethernet I/O Status

Main Menu > System > Communications > Ethernet I/O > Status

The Ethernet I/O Status screen can be used to verify that the Ethernet wiring has been correctly set up. In addition to determining if the link has been established, incoming and outgoing traffic can be monitored.

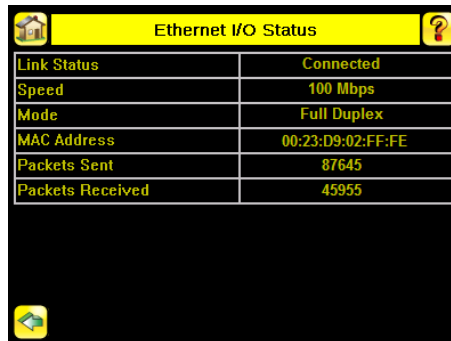

Serial I/O

Main Menu > System > Communications > Serial I/O

Set Serial I/O settings for Baud Rate, Data Bits, Parity Control and Stop Bits on this screen. Clicking Status displays recent bytes transmitted through this channel.



Port Status

Main Menu > System > Communications > Serial I/O > Status

The Port Status screen can be used to ensure data is entering and exiting the sensor. This can be useful for debugging issues such as improper wiring, mismatched baud rates, or other serial I/O issues.



Industrial Ethernet

Main Menu > System > Communications > Industrial Ethernet

The iVuPlus device can be controlled or monitored over Industrial Ethernet using Ethernet/IP, Modbus/TCP or PCCC protocols. This document will help you to set up the iVu Plus in the desired configuration and provide you with information you will need to connect to the master device (PLC, HMI, etc.).

Connection

Main Menu > System > Communications > Industrial Ethernet > Connection

The Connection screen is used to enable either Modbus or EIP/PCCC protocols on Industrial Ethernet channel. Select 'Disable' to completely disable Industrial Ethernet channel.

Status

Main Menu > System > Communications > Industrial Ethernet > Status

The status screen displays information about the current connection. This information is protocol specific.

View Logs

Main Menu > System > Communications > Industrial Ethernet > View Logs

This screen displays the list of recent events on Industrial Ethernet channel. Detailed logging can be selected under Setup when troubleshooting.

Command Channel

Main Menu > System > Communications > Command Channel

The iVu command channel is a bi-directional communication protocol that currently supports ASCII via the RS-232 serial interface or ethernet interface, and enables other devices to remotely control the iVu sensor and to access sensor results.

Connection

Main Menu > System > Communications > Command Channel > Connection

The Connection screen is used to enable or disable the Command Channel.

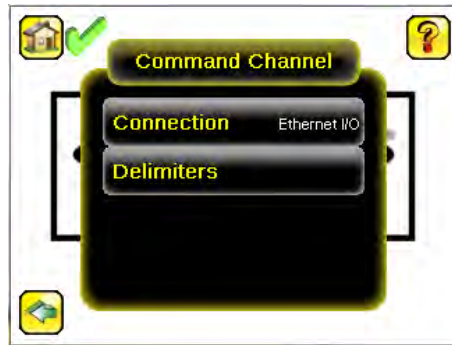

Delimiters

Main Menu > System > Communications > Command Channel > Delimiters

In the Delimiters screen, there are three delimiter options that you can set:

- Field Delimiter, which determines what is used to separate data that the sensor is sending out to a remote device.
- End of Frame, which determines the delimiter used to indicate the end of a frame.
- String Delimiter, which determines what is used to enclose a string field during both input and output operations.

Use the drop-down lists to select the appropriate delimiter. The example at the lower part of the screen displays how the data will look in the output or input streams.

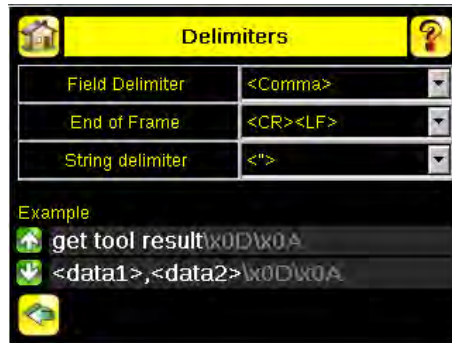

Data Export

Main Menu > System > Communications > Data Export

When the Data Export is enabled, the sensor will transmit selected inspection data when triggered.

Connection

Main Menu > System > Communications > Data Export > Connection

The Connection screen is used to enable or disable the Data Export.

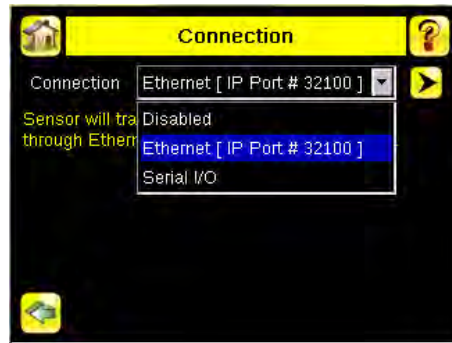

Data To Export

Main Menu > System > Communications > Data Export > Data To Export

The options in the Data To Export screen are used to determine what barcode data is exported via the serial port.



NOTE: Grab the edge of the Data to Export menu and pull down to allow all information to show.



Output Format

Main Menu > System > Communications > Data Export > Output Format

In the Output Format screen, use the drop-down lists to select Start and End Strings as well as a Delimiter. In the field at the bottom of the screen is an example of how the data will look when it is output.

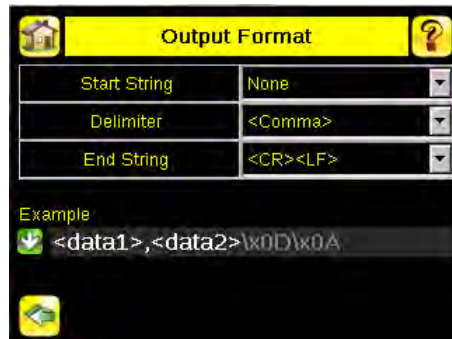

Data Export Advanced

Main Menu > System > Communications > Data Export > Advanced

During the Data and Image export operation, the sensor's output channels might become full. This can occur if the sensor is producing export data (frames) faster than the data can be exported from the device or faster than the client is reading the channel export data (due to bandwidth limitations).

This setting affects how the sensor will behave in this situation.

Select 'Hold READY' to ensure that all frames are transmitted. In this case, the READY signal will remain inactive (sensor is busy) until the new frame has been added to the channel for transmission. Triggers might be missed during this time.

Select 'Do not hold READY' to cause the sensor to discard the new frame if the channel is full and thus activate the READY signal immediately after the current inspection is complete. In this case, the discarded frames will not be transmitted.



NOTE: This setting affects both the Data Export Channel and Image Export Channel.

Image Export

Main Menu > System > Communications > Image Export

When the Image Export Channel is enabled, the sensor will transmit the acquired image on every trigger. The image is transmitted as a bitmap (BMP) file. This operation is only available over Ethernet I/O.

Connection

Main Menu > Communications > Image Export > Connection

The Connection screen is used to enable or disable the Image Export.

Image Type

Main Menu > System > Image Export > Image Type

Choose between JPEG or BMP format for the exporting image file.

Image Export Advanced

Main Menu > System > Communications > Image Export > Advanced

During the Data and Image Export operation, the sensor's output channels might become full. This can occur if the sensor is producing export data (frames) faster than the data can be exported from the device or faster than the client is reading the channel export data (due to bandwidth limitations).

This setting affects how the sensor will behave in this situation.

Select 'Hold READY' to ensure that all frames are transmitted. In this case, the READY signal will remain inactive (sensor is busy) until the new frame has been added to the channel for transmission. Triggers might be missed during this time.

Select 'Do not hold READY' to cause the sensor to discard the new frame if the channel is full and thus activate the READY signal immediately after the current inspection is complete. In this case, the discarded frames will not be transmitted.



NOTE: This setting affects both the Data Export Channel and Image Export Channel.

4.2.6 Discrete I/O

Main Menu > System > Discrete I/O

The Discrete I/O options are used to adjust iVu input and output settings.

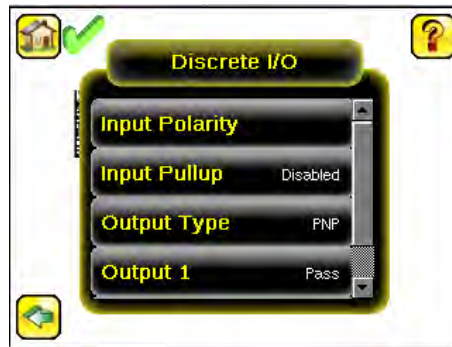

Input Polarity

Main Menu > System > Discrete I/O > Input Polarity

The iVu has two input signals—Trigger and Remote Teach. Both of these signals are edge sensitive. The operation of these signals is dependent on the Input Polarity setting.

- Low To High - The Trigger and Remote Teach are detected on a low to high transition of the signal.
- High To Low - The Trigger and Remote Teach are detected on a high to low transition of the signal.

The default setting for a PNP sensor is Low To High, and for an NPN sensor it is High To Low. The user can change the setting on the Input Polarity screen.

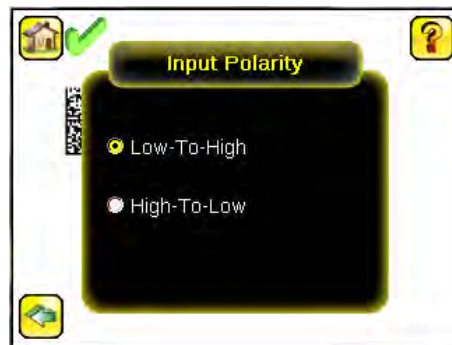

Input Pullup

Main Menu > System > Discrete I/O > Input Pullup

By default, the Input Pullup is disabled. If the device used to trigger and remote teach the iVu sensor is a Sinking device (NPN) then you will only need to enable Input Pullup here if that device does not have its own pullup resistor. Otherwise, this should be disabled.

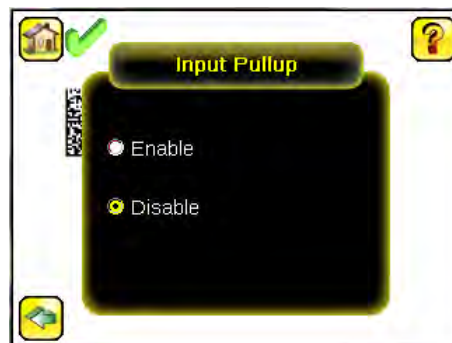

Output 1

Main Menu > System > Discrete I/O > Output 1

Output 1 can be configured for Inspection Pass, Inspection Fail, Read, No Read, Match, No Match, Missed Trigger, or System Error.

- A Read condition is when the configured number of barcodes are found in a scan. These barcodes must be error-free.
- A No Read condition is when the configured number of barcodes are not found in a scan sequence. This will not occur in Continuous Scan mode.
- If Data Compare is disabled, Inspection Pass and Inspection Fail are the same as Read and No Read.
- If the sensor is using Data Compare, Inspection Pass indicates that a good barcode was found, and the data compared.
- If the sensor is using Data Compare, Inspection Fail indicates that either no good barcode was found, or the data did not compare.
- A Match condition occurs when the required number of barcodes are found and the compare is successful.
- A No Match condition occurs when the required number of barcodes are found, but the compare is not successful.
- A Missed Trigger condition occurs when a trigger is received while sensor is busy inspecting the pervious image. This output signal will be set to active state. This signal will be reset up on resetting the 'History' on the statistics page.
- A System Error condition occurs when a fatal error is detected on the sensor. This output signal will be set to active state. This signal can be reset upon resetting the 'History' on the statistics page, or executing a 'ClearSystemError' command through command channel.

The default setting is Inspection Pass and Latched for Output 1. If Pulsed is selected, the default Pulse width is 50 ms.



NOTE: For Latched the signal is active until the results of an inspection cause a change in the signal output.

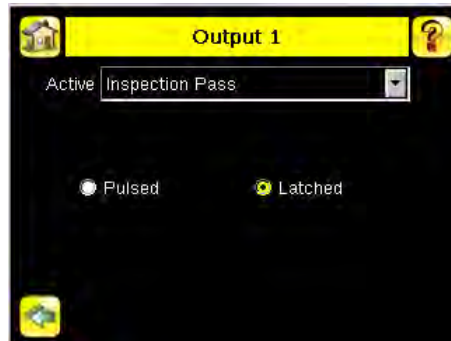

Output2 and Output3

Main Menu > System > Discrete I/O > Output 2

Main Menu > System > Discrete I/O > Output 3

Output 2 and Output 3 can be configured in a similar way as Output 1.

The default setting for Output 2 is Fail and Latched. The default setting for Output 3 is Pass and Latched.

Output Type

Main Menu > System > Discrete I/O > Output Type

Select NPN to configure the sensor's outputs to sink current. Select PNP to configure the sensor's output for source current.

4.2.7 Display Settings

Main Menu > System > Display Settings

The Display Settings menu is for setting the Fail Hold Time, LCD Timeout, and doing a Touch Screen Calibration. Display optimization can be enabled in the Advanced menu.

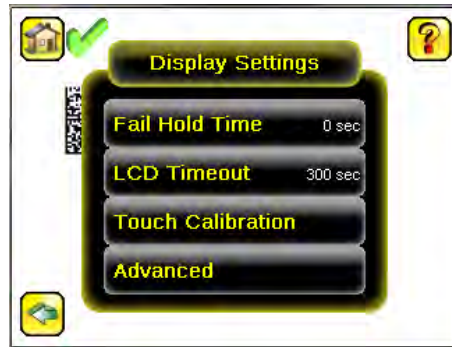

Fail Hold Time

Main Menu > System > Display Settings > Fail Hold Time

The Fail Hold Time determines how long a failed image is displayed on the LCD so that you can see what failed. The sensor will continue to process any triggers and the inspection will continue normally. This time delay is just for the screen. You can set this parameter from 0 to 3600 seconds using the slider at the bottom of the screen.

LCD Timeout

Main Menu > System > Display Settings > LCD Timeout

The LCD screen dims after a user-selectable period when the device is not being used. Use the arrow keys or slide the bar at the bottom of the screen to set the LCD screen time out.



NOTE: This screen is not available in the Emulator.

Touch Calibration

Main Menu > System > Display Settings > Touch Calibration

Touchscreen Calibration may be necessary if the software does not correctly respond when an icon on the screen is pressed. The calibration routine aligns the touch screen's coordinates to the display behind it. Be sure to follow the prompts on the screen when executing the Touchscreen Calibration function.



NOTE: This screen is not available in the Emulator.

Advanced

Main Menu > System > Display Settings > Advanced

The Advanced Display screen allows you to enable the Optimize Display Response option. This feature helps to make the display more responsive when the sensor is busy (either inspection times are long and/or no idle time exists between inspections). Disable this feature if Missed Triggers occur due to touchscreen presses. With this setting disabled, the display may become sluggish when the sensor is busy.

4.2.8 Reboot Sensor

Main Menu > System > Reboot Sensor

The Reboot Sensor screen allows you to force a reboot of the sensor.



NOTE: This option is not available on the Emulator.

4.2.9 Firmware Update

Main Menu > System > Firmware Update

The Firmware Update screen is used to load the latest sensor firmware. The Firmware Update screen lists the firmware versions it finds in the BANNER\FIRMWARE folder on the USB flash drive. When you receive a firmware update from Banner Engineering, be sure to put it in the BANNER\FIRMWARE folder on the USB flash drive.



NOTE: The Firmware Update menu is not available in the Emulator.

4.3 Imager Menu

Main Menu > Imager

The Imager menu icon is on the Main Menu, and lists parameters that affect the characteristics of the captured image. The Imager menu is used to access the Auto Exposure routine, manually adjust Exposure and Gain, set Trigger and Strobe options as well as the size of the field of view (FOV).

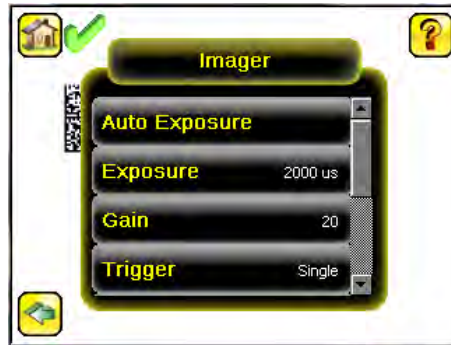

4.3.1 Auto Exposure

Main Menu > Imager > Auto Exposure

Auto Exposure optimizes the exposure time and gain for the current lighting conditions. Multiple triggers are required to complete this function.



NOTE: The Auto Exposure option is not available on the Emulator.

4.3.2 Exposure

Main Menu > Imager > Exposure

Exposure is the amount of time the sensor allows light to energize the imager. Increasing the exposure time by moving the slider to the right allows more light to energize the imager, which brightens the image.



NOTE: This feature is not effective on the emulator.

4.3.3 Gain

Main Menu > Imager > Gain

Gain is an electronic boost to the image signal. Increasing Gain by using the '-' and '+' keys or moving the slider to the right increases image brightness without increasing exposure time. Note that Gain brightens both the light pixels and dark pixels and may reduce the image quality.



NOTE: This feature is not effective on the emulator.

4.3.4 Trigger

Main Menu > Imager > Trigger

A Trigger is a signal that makes the sensor capture a barcode image and decode it. From the drop-down list, select either Continuous Scan, External - Single, External - Gated, Industrial Ethernet Only, or Command.

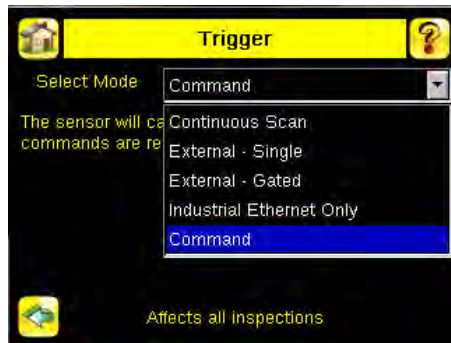

External-Single Mode

In External-Single mode, the sensor depends on an external trigger. For each trigger, the sensor captures an image and executes one scan through the configured barcode types looking for the specified number of barcodes. This trigger mode uses the Scan Time Limit parameter (Main Menu > Inspection > Barcode > Scan Time Limit) to limit the amount of time the sensor will attempt to scan for barcodes on an image.

Continuous Mode

In Continuous mode, the sensor uses internal timing to continuously capture images. For each captured image, the sensor scans through the configured barcode types looking for the specified number of barcodes. If the specified number of barcodes is found, a Read event occurs. If the specified number of barcodes is not found, the sensor captures another image and repeats the scan. There are two parameters that are used to fine-tune how Continuous Scan mode operates:

- Same Code Reject Time (set at the bottom of Main Menu > Imager > Trigger)—time in seconds that must elapse before the scanner will report a previously scanned symbol again. A different symbol will be read immediately.

- Scan Time Limit (Main Menu > Inspection > Barcode > Scan Time Limit)—limits the amount of time the sensor will attempt to scan for barcodes on an image.



NOTE: A No Read condition will not occur in Continuous mode as another image capture and scan automatically follows.

External-Gated Mode

External-Gated mode is similar to Continuous mode. While an external trigger input signal is active, the sensor continues to capture images and run barcode scans until a successful Read occurs or the External Trigger input signal becomes inactive. The External - Gated mode uses the Scan Time Limit parameter (Main Menu > Inspection > Barcode > Scan Time Limit) to limit the amount of time the sensor will attempt to decode barcodes on an image.



NOTE: A No Read condition will not occur in External - Gated mode while the external trigger is active.

Command Mode

In Command mode, the sensor captures images when Trigger commands are received. The various trigger command modes described above can also be set through a command channel. Refer to the Communications guide for specific commands. The commands can come from either Serial I/O or Ethernet I/O.

Industrial Ethernet Only

When Industrial Ethernet communication channel is enabled, triggers can be received from the modes mentioned above. Triggers through Industrial Ethernet will not be executed if selected Trigger Mode is 'Continuous Scan'. If it is desired to receive triggers only through Industrial Ethernet channel, select 'Industrial Ethernet Only'.

4.3.5 Focus

Main Menu > Imager > Focus

The Focus Number displayed at the bottom of this screen is used to fine-tune image focus. Loosen the lock on the lens cover, turn the focus ring on the sensor until the Focus Number peaks (or the image appears sharp), then lock the focus ring.



NOTE: For the Focus Number to work, the sensor must be triggering and the images must be similar over time.



4.3.6 Strobe

Main Menu > Imager > Strobe

The Internal Strobe configures the operation of the integrated ring light. The External Strobe configures the operation of an external light.

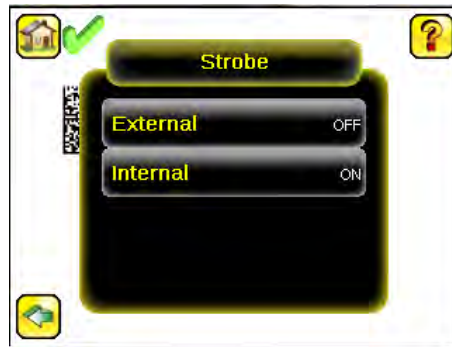

External

Main Menu > Imager > Strobe > External

The External Strobe is a 5V output that can be used for an external light. Setting options are Always ON, Always OFF, or Exposure Based. If Exposure Based is selected, then the external light is on during the time the sensor is capturing an image.

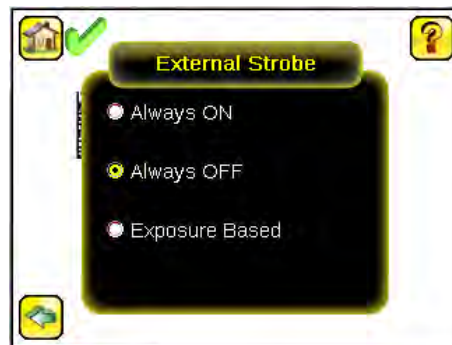

Internal

Main Menu > Imager > Strobe > Internal

The Internal Strobe setting configures the operation of the integrated ring light. Strobe options are Always ON, Always OFF, or Exposure Based. If Exposure Based is selected, then the ring light is on during the time the sensor is capturing an image. For UV models, the Always ON option is not available.

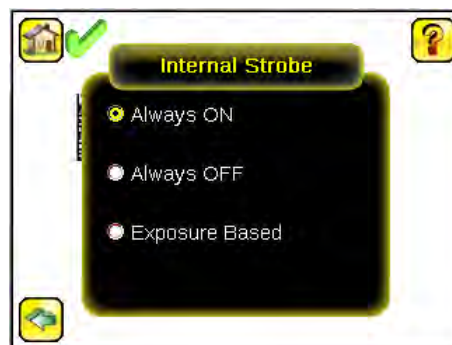

4.3.7 FOV (Field of View)

Main Menu > Imager > FOV

The field of view (FOV) is the area that the sensor can see at a given working distance. The working distance is the distance from the sensor's lens cover to the part being inspected. The effective FOV can be reduced in order to speed up the processing time of an inspection or to decrease background noise.

Adjust the Field of View

Select the resize icons to adjust the FOV. After pressing the back button, the Imager menu FOV button updates to say "Custom" to indicate that a custom FOV is in use.

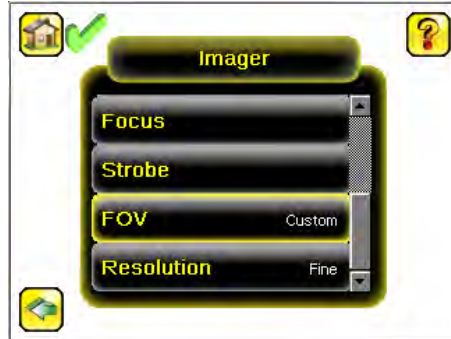

The maximum FOV is 752×480 for Fine resolution and 376×240 for Coarse resolution. To quickly set the FOV to the maximum, click Set Max. The green box representing the FOV expands to fill the screen.



4.3.8 Resolution

System > Imager > Resolution

Two resolution options are available on the iVu Plus BCR: Fine and Coarse.



Coarse resolution has a maximum FOV of 376×240 pixels, and Fine resolution has a maximum FOV of 752×480 pixels. Fine resolution has 4 times more pixels than Coarse resolution. Inspection performance may be affected when using Fine resolution, depending on the application. By default, the FOV is set to the maximum FOV size (752×480) in Fine resolution mode.

4.4 Inspection Menu

Main Menu > Inspection

The Inspection menu icon is located on the Main Menu. The Inspection Menu provides options to set inspection parameters on currently running inspection and manage stored inspections.

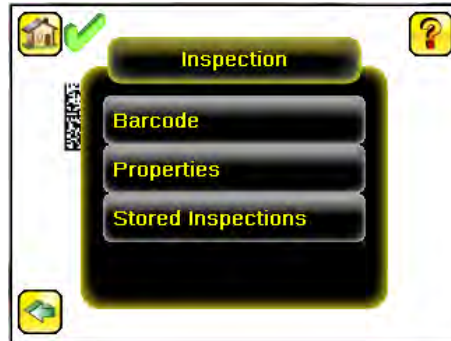

4.4.1 Barcode Menu

Main Menu > Inspection > Barcode

The Barcode Menu is the location for Barcode Type, Barcode Count, and Data Compare screens.

Barcode Type

Main Menu > Inspection > Barcode > Barcode Type

The first time the sensor is powered up, the selection checkboxes for DataMatrix and All Linear barcode types are checked. The best practice is to check only the barcode type(s) applicable for your particular application. Note that, if All Linear is unchecked, a single linear barcode type can be selected instead.

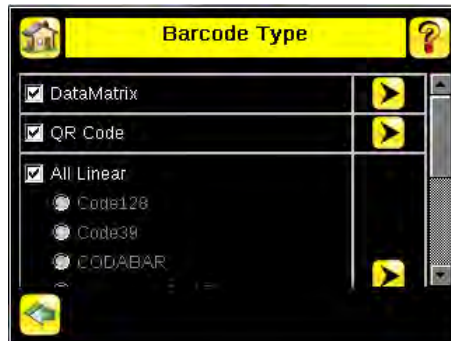

DataMatrix Settings

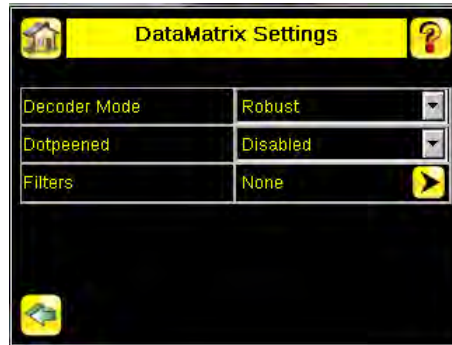

Decoder Mode

The Decoder Mode determines which decode algorithm to use and how imperfections in barcode images are handled. When you select Fast from the drop-down list, the sensor uses an algorithm that is tailored for speed. The algorithm does NOT correct for barcode image imperfections. The Fast setting has the best results on high-contrast images that contain high-quality barcodes. When you select Robust, the sensor uses an algorithm that performs routines to correct for imperfections of the barcode image. When Equalization is selected, the sensor tries to improve the contrast within the symbol to improve readability.

Dotpeened

Enabling Dotpeened causes the decoder to be run in a method that is optimized for dot peened data matrix barcodes.

Filters

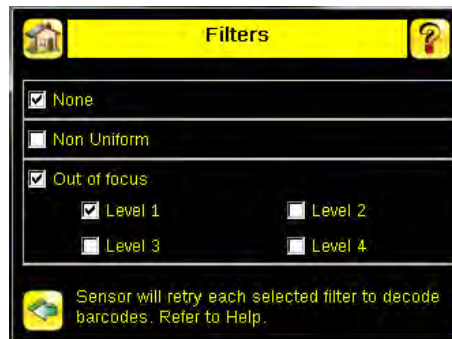

Use filters to improve decode rates in conditions in which the barcodes are blurred or have nonuniform module sizes. Select one or more Out-of-focus filters to improve the decode rate of out-of-focus barcodes. Select the Non Uniform filter to improve the decode rate of barcodes with non-uniformly sized data modules. The time required to read the barcode data may increase with the number of selected filters. The sensor will run the most successful filter (since boot-up) first before trying other filters. Select None to force the sensor to first try to decode barcodes without applying any filters.

QR Code Settings

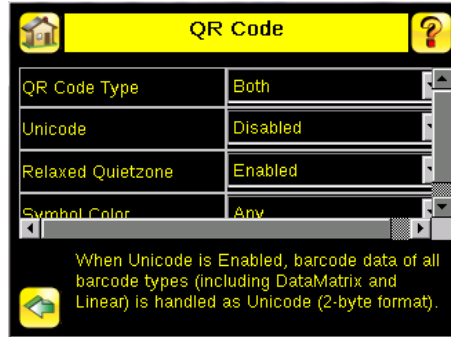

QR Code Type

The QR Code Type determines whether the device should decode a QR Code, Micro QR code, or both.

Unicode

The device is capable of decoding Kanji characters embedded in a QR Code. In order for the device to display the decoded data correctly, and be able to export the decoded data in Unicode format (2 byte), this setting should be enabled. Decoded data sent out on Communication Channels will also be in unicode format. The Compare Data will also be stored in unicode format. Enabling this feature affects data decoded from all barcodes in the inspection, irrespective to their symbology.

All Linear Settings

The All Linear settings described below apply to the following barcode types:

- Code 128
- Code 39
- CODABAR
- Interleaved 2 of 5
- EAN13
- EAN8
- UPCE
- Postnet
- IMB

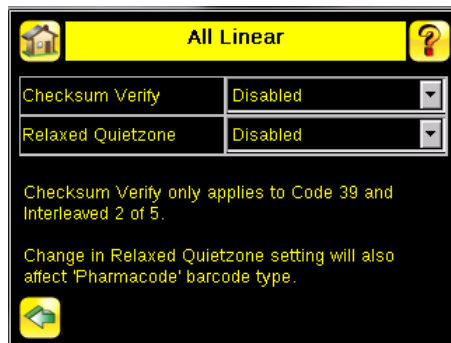

Checksum Verify

When checksum is enabled, the sensor uses a checksum to verify the integrity of the barcode being read.

Relaxed Quietzone

The Quietzone is a blank margin on either side of a barcode that indicates where the barcode begins and ends. If this Quietzone isn't big enough, the sensor can have trouble decoding the barcode. By enabling Relaxed Quietzone there is a greater tolerance with respect to the quiet zone required before and after the barcode.

Pharmacode Settings

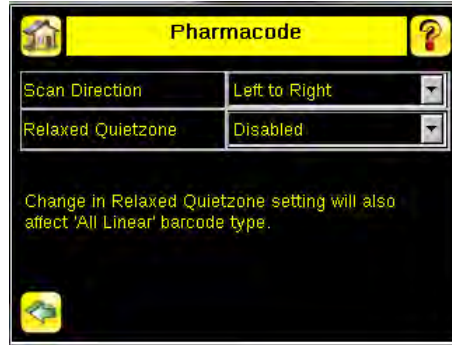

Scan Direction

For Pharmacode, select one of the following for Line Scanning:

- Left to Right
- Right to Left
- Top to Bottom
- Bottom to Top
- Omnidirectional

Use Omnidirectional scanning if barcode can appear inverted on part being inspected. If 'Compare' is enabled, the sensor attempts to compare that string to decoded data in both scan directions. Inspection is marked as PASS if at least one string matches. The data that successfully matched is displayed on the screen and is exported through communication channels as requested.

If Omnidirectional scan is selected, but 'Compare' is disabled, the data decoded from left-to-right scan is reported.

Relaxed Quietzone

The Quietzone is a blank margin on either side of a barcode that indicates where the barcode begins and ends. If this Quietzone isn't big enough, the sensor can have trouble decoding the barcode. Enabling Relaxed Quietzone creates a greater tolerance with respect to the quiet zone required before and after the barcode.

Barcode Count

Main Menu > Inspection > Barcode > Barcode Count

In the Barcode Count screen, select the number of barcodes you want to decode. You can select from 1 to 10.



NOTE: For IMB, Postnet and Pharmacode barcode types, the sensor will decode only one barcode for each of these types regardless of the Barcode Count setting. This means that if there is one of each of these types in an image, and the Barcode Count is set to 3, the sensor will decode all three; however, if there are three IMB barcodes, for example, the sensor will always only decode one IMB barcode.

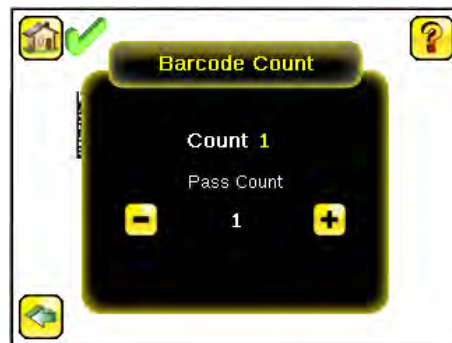

Data Compare

Main Menu > Inspection > Barcode > Data Compare

The menu options here are used to set up the sensor for Data Compare. Note that, if the Barcode Count is greater than 1, only the first barcode data can be compared or used in a remote teach operation. Turn on annotations to see which barcode is first.

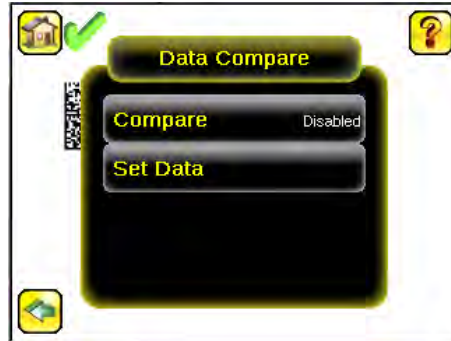

Compare

Use this menu to enable or disable Data Compare. If Data Compare is enabled, data can be defined in the Compare Data screen. The data can be retrieved from a previously scanned barcode, or it can be entered using the software keyboard on the touch screen, and insignificant characters can be masked within the data.

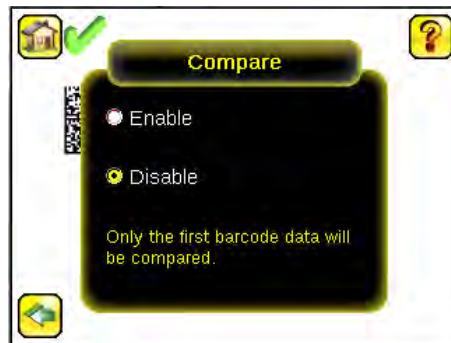

Compare Data

The Compare Data screen allows you to specify data against which you can compare a read barcode. Note that, if the Barcode Count is greater than 1, only the first barcode data can be compared or used in a remote teach operation. To see which barcode is the first one, turn on annotations.

- Click the Show last read data button to use the last read barcode data for the data compare.
- Click the Edit button to enter data using a software keyboard on the touch screen.
- Click the Mask button to select characters in the data to mask from the data compare. To mask a character, use the arrows at the bottom of the screen to move the cursor (|). When the cursor is to the left of a character you want to mask, click the Mask button. The character will change to green with a slash through it. If you want to unmask a character, make sure that the cursor is to the left of the masked character, and click the Unmask button.

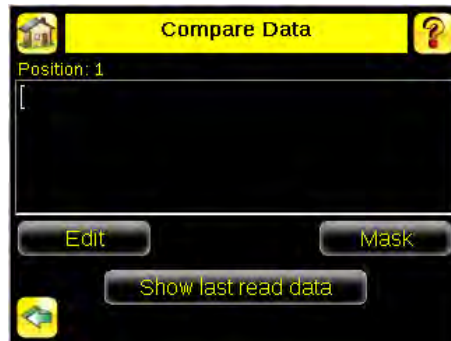

Edit Compare Data

The Edit screen displays data that was previously read or entered in the text field. The Position of the cursor within the characters displayed (|) in the text field is indicated at the top of the screen. Additionally, the number of characters is indicated by Length. Use the left and right arrows below the software keyboard to move the cursor between the displayed characters. Place the cursor to the right of any character and use the back-arrow at the top of the screen to delete that character. Use the button at the bottom right of the screen to cycle through different character entry keyboards: text entry (with a button to toggle between upper- and lower-case characters), numeric entry, special character entry, and hex character entry.

Last Read Data

Click Show last read data to use the last read barcode data for the data compare.

Mask Data

To mask characters in the data, move the cursor to the left of the character(s) to be masked, and click the Mask button. A masked character will appear gray with a strikethrough (\) indicator. To unmask a previously masked character, click the UnMask button. Note that, when using Remote Teach to set new barcode data, if the previous input data contained any masked characters, Remote Teach will retain the masked characters only if the new data is of the same length as the previous input data. If the length does not match, masking is removed.



4.4.2 Properties

Main Menu > Inspection > Properties

The Properties menu is used to edit an Inspection Name or set the Scan Time Limit.

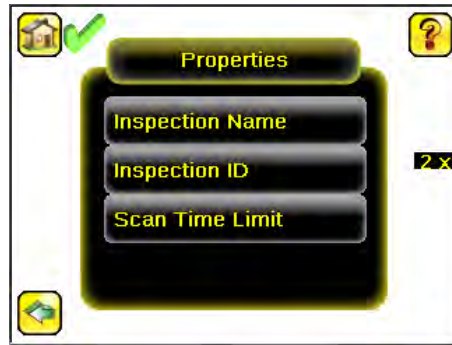

4.4.3 Stored Inspections

Main Menu > Inspection > Stored Inspections

Stored Inspections is used to manage stored inspections. Management of stored inspections includes adding, deleting, and specifying which inspection should be defined as the Startup inspection.



From the Stored Inspections menu click Select, Add New, Startup, Delete, or Set Name/ID

Select

Main Menu > Inspection > Stored Inspections > Select

This screen is used to select a new running inspection. Select the name of the inspection to start, and click the Start Running button that displays.

Add New

Main Menu > Inspection > Stored Inspections > Add New

The Add New button is to add a new inspection. The sensor can store up to 30 inspections. When you add a new inspection, it will begin running. When adding a new inspection, you can specify the name for the new inspection.

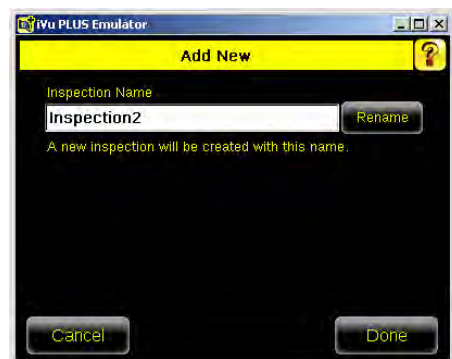

Startup

Main Menu > Inspection > Stored Inspections > Startup

The Startup button allows you to select the inspection to use as the startup inspection. The selected inspection will automatically start after power up.

Delete Inspections

Main Menu > Inspection > Stored Inspections > Delete

The Delete button is used to delete stored inspections. Note that any running inspection, or the inspection marked as the Startup inspection, cannot be deleted.

Set Name/ID

Main Menu > Inspection > Stored Inspections > Set Name/ID

The Set Name/ID button is used to change the name or ID of an inspection. You can sort the inspections in numeric or alphabetical order by clicking on the icon beside the Help icon. Click on Name to edit the name of the inspection. Click on ID to change the ID of the inspection.

4.5 Logs Menu

Main Menu > Logs

The Logs menu icon is on the Main Menu, and is used to set up, view, and save Inspection, Communication, and System Logs.

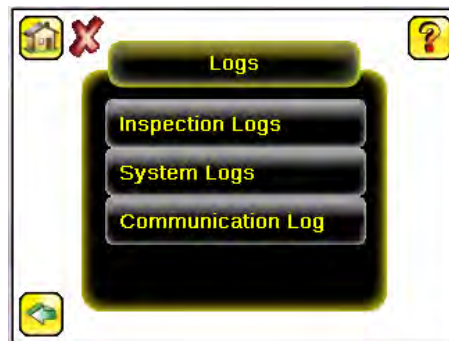

4.5.1 Inspection Logs

Main Menu > Logs > Inspection Logs

This menu provides for configuring and viewing Inspection Logs. Inspection Logs are stored inspection records that include a captured image, the parameters used to inspect it, and the results of that inspection. Up to ten Inspection Logs can be held in memory on the sensor. The next ten overwrite the previous. Inspection Logs can be saved to the USB flash drive so that the logs can be imported to the emulator.

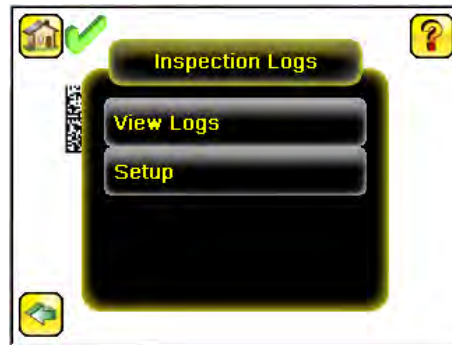

View Logs

Main Menu > Logs > Inspection Logs > View Logs

Inspection Logs appear as a strip of film. You can select a frame to view a specific image. Use the icon in the lower right of the screen to save the logs to the USB flash drive. Logs saved to the USB flash drive can be imported into the emulator. Click the Clear button to clear Inspection Logs.



The View Inspection Log screen is used to debug an inspection, and shows one inspection in read-only mode. Click the upper-left icon to cycle through views. When in Statistics view, the table title has arrows to switch between Inputs and Results of the Inspection.

Use the left and right arrow keys at the bottom of the screen to navigate through the all stored Inspection Logs.



Setup

Main Menu > Logs > Inspection Logs > Setup

Use the radio buttons to Disable Logging, to log Passed Inspections, Failed Inspections, or All Inspections.

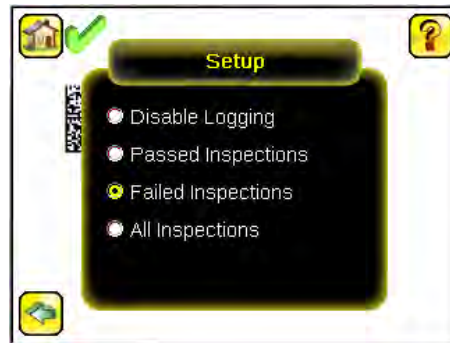

4.5.2 System Logs

Main Menu > Logs > System Logs

The System Log contains configuration change information, other notifications, and any errors or warnings that may be encountered.

- Click the icon in the upper left corner of the screen to show/hide the time column
- Click Clear Log button at the bottom of the screen to clear the System Log
- Click the icon at the lower-right of the screen to save the System Log to the USB flash drive



NOTE: System log will not log changes while in Demo mode. Additionally, the Emulator does not log changes.

4.5.3 Communication Logs

Main Menu > Logs > Communication Logs

The Communication Log contains logs for the four communications channels; Industrial Ethernet, Command Channel, Data Export, and Image Export. The features below are available for each of the logs:

- Click the icon in the upper left corner of the screen to show/hide the time column.
- Click Clear Log button at the bottom of the screen to clear the log.
- Click the icon at the lower-right of the screen to save the Log to the USB flash drive.



NOTE: Communication log will not log changes while in Demo mode. Additionally, the Emulator does not log changes.

5 Setting up an Inspection

To set up for an inspection:

1. Acquire a good image.
2. Set up a barcode application.
3. Set data compare parameters.

5.1 Acquiring a Good Image

The iVu Series sensor needs to capture a good image to ensure that it can read the barcode(s) correctly.

1. Go to Main Menu > Imager > Auto Exposure to run the Auto Exposure routine.
2. Check the lighting.
 - Make sure that the lighting is constant and consistent (unchanging over time, no shadows or hot spots).
 - Capture the barcode with lighting that optimizes its contrast and separates it from the background. Depending on the target, this may mean the integral ring light is not the best choice and other Banner lights should be considered.
 - Adjust the mounting angle to provide the clearest image of the barcode. The mounting bracket lets you easily position and adjust the sensor on your line. Typically, a slight angle will help with read robustness.
3. If needed, go to Main Menu > Imager > Auto Exposure to run the Auto Exposure routine a second time or adjust Gain and Exposure manually:
 - Main Menu > Imager > Gain



- Main Menu > Imager > Exposure



4. Go to Main Menu > Imager > Focus to adjust the focus while monitoring the Focus Number:



5.1.1 Adjust the Focus on a Micro Video Lens Model

1. Use the supplied 1/16 in. hex key to loosen the Focusing Window locking screw (D), then adjust focus on the iVu Series sensor using the clear Focusing Window (B).
2. Adjust focus while monitoring the focus number. To ensure the best image, adjust the focus until the Focus Number peaks.



NOTE: Turning the Focusing Window counter-clockwise focuses on closer objects, while turning the Focusing Window clockwise focuses on more distant objects.



3. After the best image has been acquired, lock the focusing window.

| Micro Video Lens Models | |
|-------------------------|---|
| | A Lens |
| | B Focusing Window |
| | C Locking Clip |
| | D Locking Screw |
| | E Filter Cap (optional) |
| | F Filter (optional) |
| | NOTE: Filter Kits are available separately. |

5.1.2 Adjust the Focus on a C-Mount Lens Model

1. Remove the Lens Enclosure.
2. Adjust focus while monitoring the focus number. To ensure the best image, adjust the focus until the Focus Number peaks.
3. Replace the Lens Enclosure on the camera.

| C-Mount Models | |
|----------------|---|
| | A C-Mount Lens |
| | B Lens Enclosure |
| | C Retainer Ring (optional) |
| | D Filter (optional) |
| | E Filter Retainer Ring Tool |
| | NOTE: Filter Kits are available separately. |

5.2 Using iVu Gen1 and Gen2 Devices in the Same Application

Generation 1 and Generation 2 iVu devices can be used in the same application, however steps must be taken to ensure compatibility. Gen2 output files, such as configuration and log files, are not compatible with Gen1 devices. In order to have one configuration file that applies to both Gen1 and Gen2 devices, configure inspections using a Gen1 device or the Gen1 Emulator. Settings from Gen1 are automatically converted to Gen2 when they are loaded onto a Gen2 device. Confirm all inspections after loading to ensure that they are correct.



NOTE: New features available on Gen2 devices will not be available when creating the inspection on Gen1 software.

5.3 Setting Up a Barcode Application

This section describes how to set up the iVu Plus BCR sensor.

1. Go to Main Menu > Inspection > Barcode > Barcode Type to select one or more Barcode Types from the list.

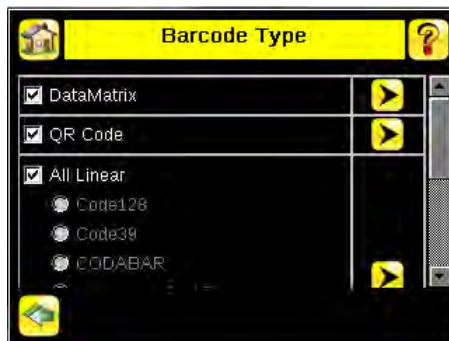

NOTE: To ensure optimal performance, select only the barcode types for your application. For example, if you use only one of the of the barcode types listed for All Linear, uncheck the box next to All Linear, and select a radio button next to the desired linear barcode type. If you use only DataMatrix, uncheck all the boxes except the one next to DataMatrix.

2. Go to Main Menu > Inspection > Barcode > Barcode Count to select the number of barcodes (1 to 10) to be read at one time.

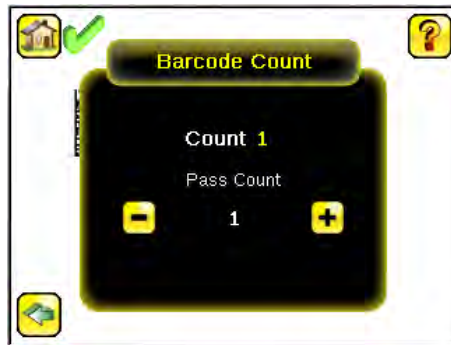

After the sensor has been set up as described:

- Each successfully read barcode is marked by a green bounding box. If annotations are on, the barcode data is also displayed.
- Any case where data does not compare is marked with a solid red bounding box. If the barcode is marked with a dotted red bounding box, this indicates a checksum error or quiet zone violation.
- Any barcodes in the field of view that the sensor does not detect (for example, because they are not one of the barcode types selected), are unmarked.

5.4 Setting up for Data Compare

This section describes how to set up the data compare feature. For this example, the reference data will be from a previously decoded barcode.

1. Go to the Main Menu > Inspection > Barcode > Data Compare > Compare to Enable data compare.

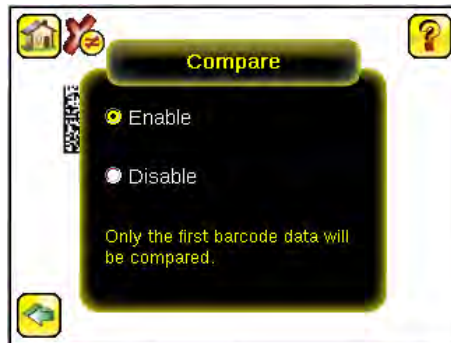

2. Go to the Main Menu > Inspection > Barcode > Data Compare > Set Data, and click Show last read data.

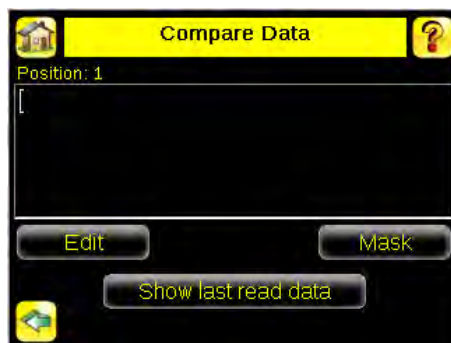

3. Click Yes.

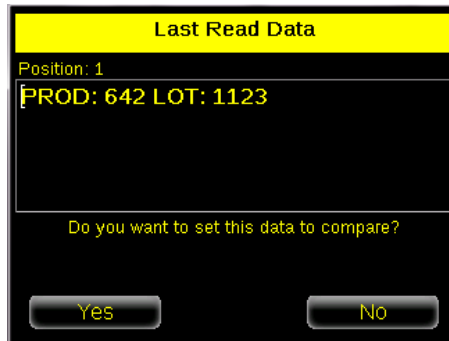

4. Click the Home icon to return to the main screen.



For all subsequent triggers, when the sensor reads the barcode data, it will compare it against this reference data.

5.4.1 Remote Teach

The Remote Teach function is a method of remotely updating inspection parameters while the iVu sensor is running. The sequence of events for executing a Remote Teach are:

1. With the sensor Ready (see [Installation](#) on page 8), pulse the Remote Teach line.
2. The sensor recognizes that the Remote Teach line has been pulsed and waits for the next valid trigger.
3. At the next valid trigger, Ready goes inactive (the Green Ready LED shuts OFF), and the sensor acquires a new image.

When a Remote Teach occurs, the data of the first read barcode is saved as Data Compare input. Inspections executed on the next trigger uses the new data for comparison with subsequently read barcodes. If the previous input data contained any masked characters, Remote Teach retains the masked characters only if the new data is of the same length as the previous input data. If the length does not match, masking is removed.

6 Communications Guide

6.1 Introduction

The iVuPlus device can be controlled or monitored over Industrial Ethernet using Ethernet/IP, Modbus/TCP or PCCC protocols. This document will help you to set up the iVu Plus in the desired configuration and provide you with information you will need to connect to the master device (PLC, HMI, etc.).

6.2 iVu Plus Communication Summary of Ethernet and Serial

The iVu Plus communicates with other devices via Ethernet or a UART serial communications port (RS-232). In order to establish an Ethernet connection to the sensor, the external device must be configured with the correct IP address and TCP port to communicate. To use the serial communications connection, port settings for baud rate, data bits, parity, and stop bits must be configured on the iVu Plus to match the settings of the external device.

6.2.1 Communication Channels

The iVu Plus BCR supports up to four communications channels. To access the channels, go to Main Menu > System > Communications.

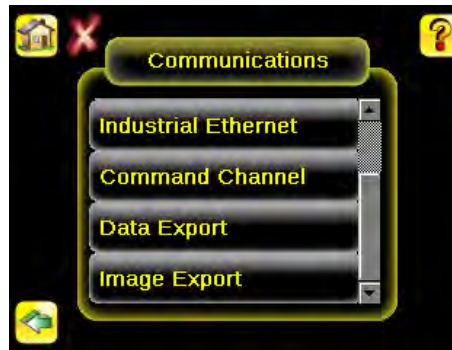

- Command Channel—a bi-directional communication protocol that currently supports ASCII and enables other devices to remotely control the iVu Plus sensor and access sensor results
- Industrial Ethernet—a bi-directional communication channel that allows the user to control the sensor and access sensor results using Ethernet/IP, Modbus/TCP, or PCCC protocol
- Data Export—used to export selected inspection data to a remote device
- Image Export—used to export inspection images to a remote device

Data export and command channel can be configured for either Ethernet or Serial I/O (but not both); image export is only available over Ethernet. The table below briefly summarizes valid communication channel configuration options.

| Command Channels | Scenario #1 | | Scenario #2 | | Scenario #3 | |
|---------------------|-------------|------------|-------------|------------|-------------|------------|
| | Ethernet | Serial I/O | Ethernet | Serial I/O | Ethernet | Serial I/O |
| Command Channel | Yes | No | No | Yes | Yes | No |
| Industrial Ethernet | Yes | No | Yes | No | Yes | No |
| Data Export | Yes | No | Yes | No | No | Yes |
| Image Export | Yes | No | Yes | No | Yes | No |

6.2.2 Industrial Ethernet

Main Menu > System > Communications > Industrial Ethernet

The iVuPlus device can be controlled or monitored over Industrial Ethernet using Ethernet/IP, Modbus/TCP or PCCC protocols. This document will help you to set up the iVu Plus in the desired configuration and provide you with information you will need to connect to the master device (PLC, HMI, etc.).

6.2.3 Command Channel

The iVu Plus BCR command channel is a bi-directional communication protocol that currently supports ASCII via either Ethernet or the RS-232 serial interface, and enables other devices to remotely control the iVu sensor and access sensor results.

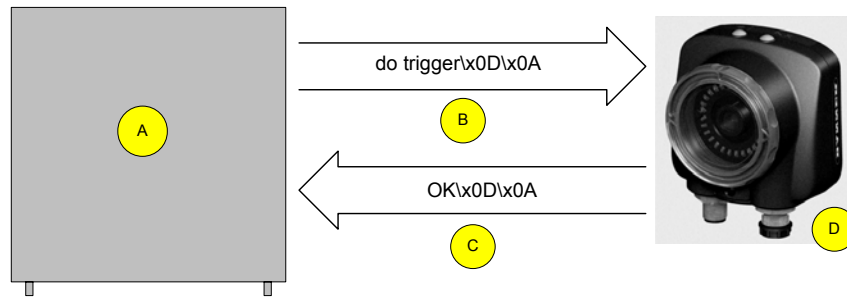

- | | | | |
|---|---|---|---------------------|
| A | Control Device, which can be a PLC, PC program, or a terminal | C | Response Frame |
| B | Request Frame | D | iVu Plus BCR Sensor |

The following are some of the functionality available via the command channel:

- Get sensor information (such as version and sensor name)
- Control "discrete" I/O (such as trigger and teach)
- Get sensor results (such as sensor status)
- Change the running inspection

Command Channel Sample Application

The iVu Plus BCR installation CD has a Command Channel sample application that provides an easy interface to execute commands. In a production environment, you will need to create your own application for bi-directional communication with the sensor.

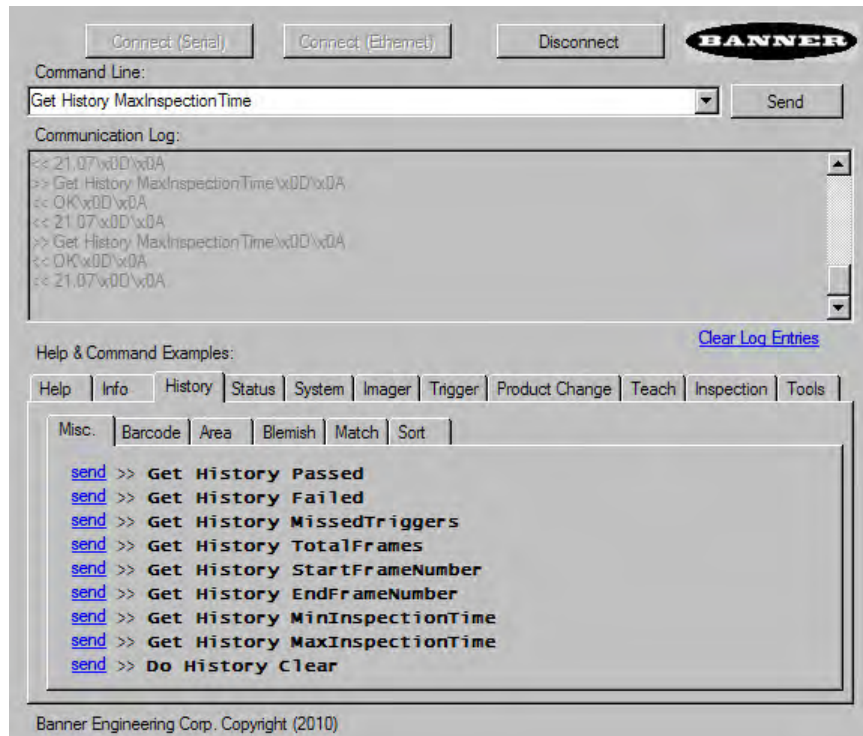

6.2.4 Data Export

The iVu Plus sensor provides for exporting user-selected inspection data via either Ethernet or the RS-232 serial interface. Inspection data that can be exported includes:

- Pass/Fail Output
- Inspection Name
- Sensor Result
 - Pass/Fail
 - Sensor Result (see [Table 5](#) on page 55 for additional information)
- Frame #
- Inspection Time (ms)

Table 5: Sensor Results

| Sensor Type | Data to Export |
|-------------|----------------|
| Barcode | Barcode Count |
| | Data Length |
| | Symbol Type |
| | Barcode Data |

Sample Application

The iVu Plus BCR installation CD has a Data Export sample application that provides for viewing exported data while setting up the sensor, etc. In a production environment, you will need to create your own application to process data exported from the sensor.

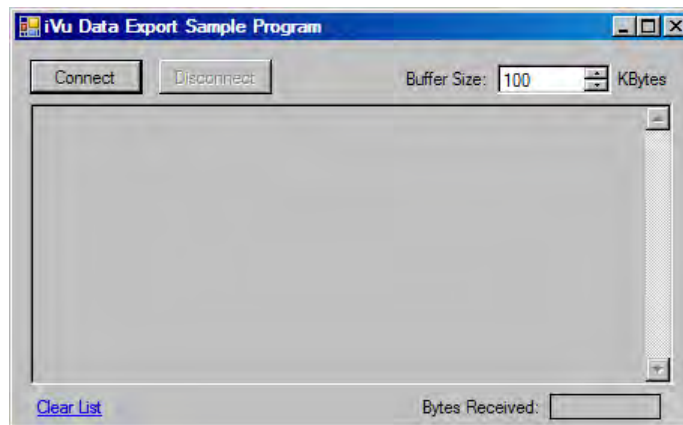

6.2.5 Image Export

Image export is only supported on Ethernet ports. Inspection images are a maximum 752×480 8-bits per pixel grayscale images in Windows BMP format that represent all the data in a full Field of View (FOV).

Each exported image is comprised of a header (64 bytes) followed by the image data (approximately 361K). All 16- and 32-bit numeric entries are little endian.

The header includes the following information:

| Byte Offset | Field ID | Size in Bytes | Data Type | Description |
|-------------|--------------------|---------------|-----------|--|
| 0-15 | Header Prefix | 16 | char | "IVU PLUS IMAGE" |
| 16-19 | Header Version | 4 | UInt32 | 1 |
| 20-23 | Image Size | 4 | UInt32 | Number of bytes (Windows BMP image) |
| 24-27 | Image Frame Number | 4 | UInt32 | Most recently snapped image frame number |
| 28-29 | Image Width | 2 | UInt16 | 752 (max) |

| Byte Offset | Field ID | Size in Bytes | Data Type | Description |
|-------------|--------------|---------------|-----------|-------------------------|
| 30-31 | Image Height | 2 | UInt16 | 480 (max) |
| 32-33 | Image Format | 2 | UInt16 | 0: Bitmap, 1: JPEG |
| 34-63 | Reserved | 32 | byte | Reserved for future use |



NOTE: If FOV's are adjusted so that they are smaller, the bitmaps will also be smaller.

Image Export Sample Application

The iVu Plus BCR installation CD has an Image Export sample application that provides a way to save exported images. In a production environment, you will need to write your own application to process exported images, for example to display them on an HMI or to save them to disk.

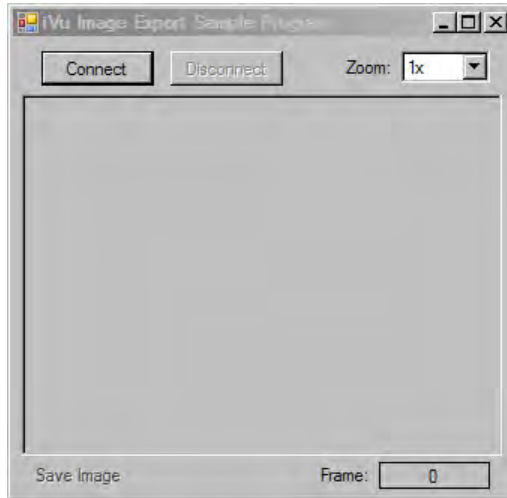

6.3 Enabling Communications

6.3.1 Setting Up Ethernet Communications

Configure both the PC and the sensor using the following instructions.

Windows XP

1. Open Network Properties on the PC (right-click on the Network Neighborhood icon).
2. On the Local Area Connection, right-click on Properties.
3. In the dialog, click on Internet Protocol (TCP/IP) and click the Properties button.

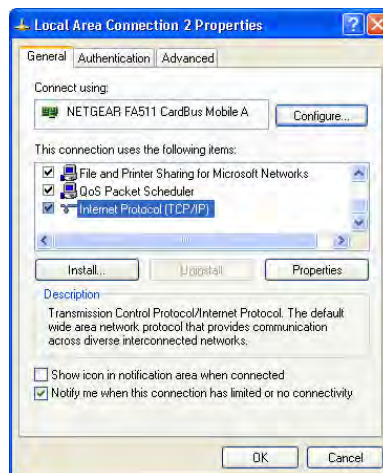

4. In the Internet Protocol (TCP/IP) Properties dialog, select Use the following IP address and make sure that the IP address is 192.168.0.2, and the subnet mask is 255.255.255.0.

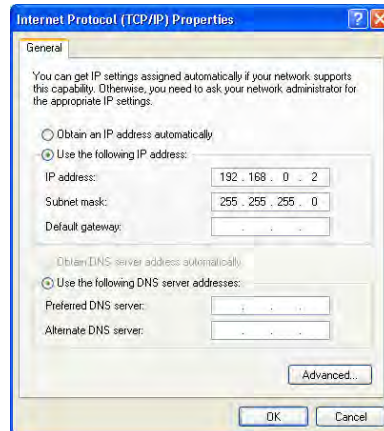

Windows 7

1. Open Network Connections by clicking on the Start button, then selecting the Control Panel followed by Network and Internet, and clicking Manage network connections.
2. Right-click the connection you want to change, then click Properties. If you are prompted for an administrator password or confirmation, type the password or provide confirmation.
3. In the Networking dialog, click on Internet Protocol Version 4 (TCP/IPv4) and click the Properties button.

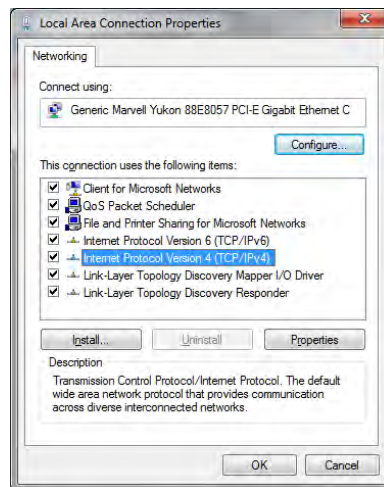

4. In the Internet Protocol (TCP/IPv4) Properties dialog, select Use the following IP address and make sure that the IP address is 192.168.0.2, and the subnet mask is 255.255.255.0.

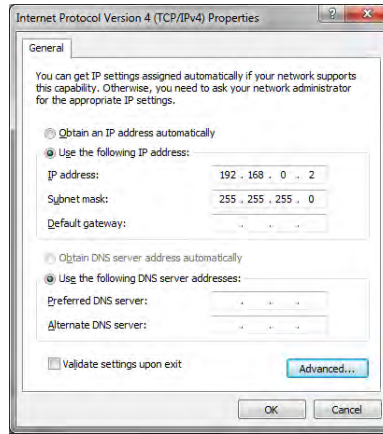

Sensor Setup for Ethernet Communications

1. Go to Main Menu > System > Communications > Ethernet I/O and make sure that the sensor is configured as shown below.

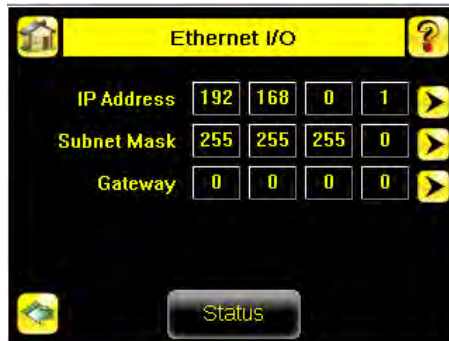

2. To enable the command channel over Ethernet:
 - a. Go to Main Menu > System > Communications > Command Channel > Connection, and select Ethernet [IP Port # 32000].



- b. Configure the field and end-of-frame delimiters. Go to Main Menu > System > Communications > Command Channel > Delimiters.

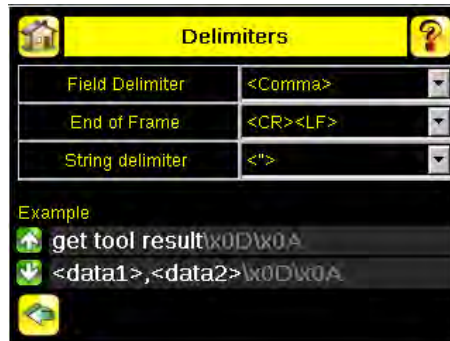

Valid end-of-frame delimiters are: <comma>, <colon>, <semicolon>, <CR>, <CR><LF>, <LF><CR>, or <ETX>.

- c. Verify that the iVu receives and transmits data correctly.
3. To enable Data Export over Ethernet:
 - a. Go to Main Menu > System > Communications > Data Export > Connection and select Serial I/O from the drop-down.



- b. Go to Main Menu > System > Communications > Data Export > Data To Export and select the inspection data to export.

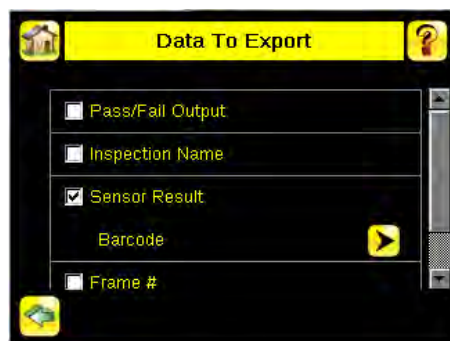

- c. Go to Main Menu > System > Communications > Data Export > Output Format and select the Start String, Delimiter, and End String.

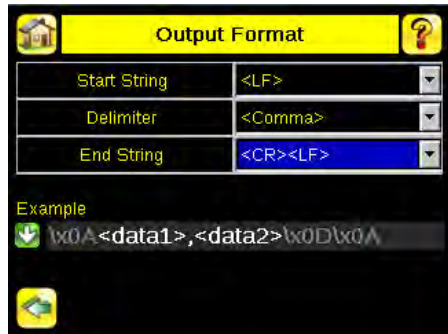

- d. Go to Main Menu > System > Communications > Data Export > Advanced.



During the Data and Image export operation the sensor's output channels might become full. This can occur if the sensor is producing export data (frames) faster than the data can be exported from the device (due to bandwidth limitations) or faster than the client is reading the channel export data.

This setting affects how the sensor will behave in this situation.

- Select Hold READY to ensure that all frames are transmitted. In this case, the READY signal will remain inactive (sensor is busy) until the new frame has been added to the channel for transmission. Triggers might be missed during this time.
- Select Do not hold READY to cause the sensor to discard the new frame if the channel is full and thus activate the READY signal immediately after the current inspection is complete. In this case, the discarded frames will not be transmitted.

Communications Channel Ports

The following are the default Ethernet port settings for the communications channels:

- Command Channel — 32200
- Data Export — 32100
- Image Export — 32000

6.3.2 Setting Up Serial Communications

1. Electrically connect the control device and the iVu sensor. On the iVu, the pins/wire colors used for serial communications via RS-232 are shown in the table below.

Table 6: iVu RS-232 Connections

| Pin # | Wire Color | Description |
|-------|------------|---------------|
| 10 | Light-Blue | TX |
| 11 | Black | Signal Ground |
| 12 | Violet | RX |

2. Configure port settings (baud rate, data bits, parity, and stop bits) on the iVu to match the settings on the control device. Go to Main Menu > System > Communications > Serial I/O.



3. To enable the command channel over the serial connection:
 - a. Go to Main Menu > System > Communications > Command Channel > Connection and select Serial I/O.
 - b. Configure the field and end-of-frame delimiters. Go to Main Menu > System > Communications > Command Channel > Delimiters.

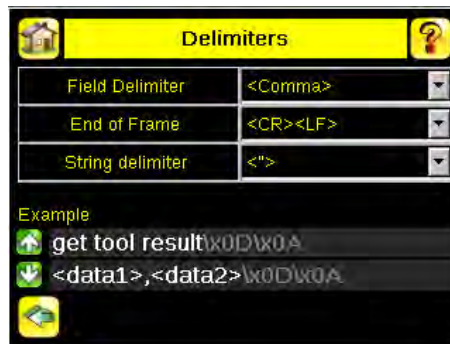

Valid end-of-frame delimiters are: <comma>, <colon>, <semicolon>, <CR>, <CR><LF>, <LF><CR>, or <ETX>.

- c. Optionally, if you want to trigger the iVu from the control device, set the trigger mode to Command (go to Main Menu > Imager > Trigger and select Command from the drop-down).

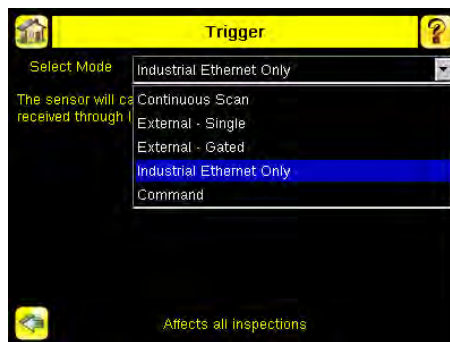

- d. Verify that the iVu receives and transmits data correctly.
4. To enable Data Export over the serial connection:
 - a. Go to Main Menu > System > Communications > Data Export > Connection and select Serial I/O from the drop-down.



- b. Go to Main Menu > System > Communications > Data Export > Data To Export and select the inspection data to export.



- c. Go to Main Menu > System > Communications > Data Export > Output Format and select the Start String, Delimiter, and End String.

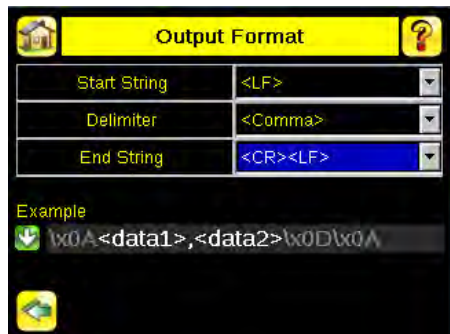

- d. Go to Main Menu > System > Communications > Data Export > Advanced.



During the Data and Image export operation the sensor's output channels might become full. This can occur if the sensor is producing export data (frames) faster than the data can be exported from the device (due to bandwidth limitations) or faster than the client is reading the channel export data.

This setting affects how the sensor will behave in this situation.

- Select Hold READY to ensure that all frames are transmitted. In this case, the READY signal will remain inactive (sensor is busy) until the new frame has been added to the channel for transmission. Triggers might be missed during this time.
- Select Do not hold READY to cause the sensor to discard the new frame if the channel is full and thus activate the READY signal immediately after the current inspection is complete. In this case, the discarded frames will not be transmitted.

6.4 Testing and Troubleshooting iVu Plus Communications

6.4.1 Understanding the Communication Log

The iVu Plus sensor includes the following Communication Logs:

- Command Channel Log that can be used to ensure that commands are properly formed (syntax is correct), and provides a history of commands issued along with responses to these commands. To access the Command Channel Log, go to Main Menu > Logs > Communication Logs > Command Channel
- Data Export and Image Output logs that are purely output logs (that is, there is no receive activity to log)



Some notes about the logs:

- To see an expanded view of each entry, click on the small right-triangle control on each entry
- To save the log, click the save icon. The saved communication log can be loaded into the emulator for troubleshooting offline

The table below describes the icons used in the Communication Log, the up-arrow indicates an incoming request to the iVu from the control device; the down-arrow indicates an outgoing response from the iVu to the control device.

| Icon | Description |
|------|--|
| | Port opened. |
| | Port closed. |
| | Indicates that the command has been processed without errors. |
| | Indicates that the incoming entry is stalled (no new bytes), or end-of-frame delimiter was not received, or client is not reading data on ethernet. |
| | If the response frame contains an error or is dropped, the log entry icons for the request and the response frames will be colored red, and the displayed error count will increment by one. |
| | If the command takes a long time to process, the last long entry will change to an hourglass (for example, during trigger of long inspections). |

For Ethernet channels:

- The channel's log will show an Enabled entry that indicates which port is being listened to
- When a client connects, a log entry is added that indicates which IP address connected

- When a client closes the connection, a log entry indicates that the channel is no longer being listened to

6.4.2 Ethernet I/O

Ethernet I/O Status

The Ethernet I/O Status screen can be used to verify that the Ethernet wiring has been correctly set up. In addition to determining if the link has been established, incoming and outgoing traffic can be monitored.

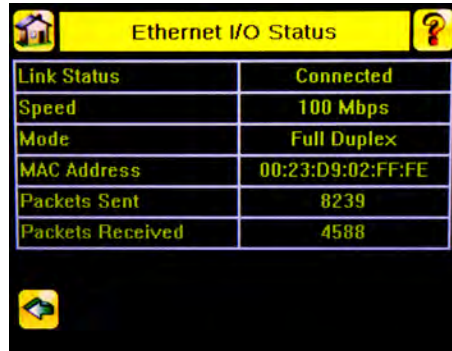

| Ethernet I/O Status | |
|---------------------|-------------------|
| Link Status | Connected |
| Speed | 100 Mbps |
| Mode | Full Duplex |
| MAC Address | 00:23:D9:02:FF:FE |
| Packets Sent | 8239 |
| Packets Received | 4588 |

6.4.3 Serial I/O

Using the Port Status Screen for Testing RS-232 Communications

The Port Status screen can be used to ensure data is entering and exiting the sensor. This can be useful for debugging issues such as improper wiring, mismatched baud rates, or other serial I/O issues. To access the Port Status screen, go to Main Menu > System > Communications > Serial I/O and click on the Status button.

- The upper field shows the bytes received (request frame) on the iVu from the control device.
- The lower field shows the bytes sent (response frame) from the iVu to the control device.



| Port Status | |
|--|-------------------------------|
| Last Bytes Received (22 Total): | do trigger\x0D\x0A do trigger |
| Last Bytes Sent (4 Total): | OK\x0D\x0A |
| Port Status: No Errors | |
| <div style="display: flex; justify-content: space-around;"> Clear HEX </div> | |

Port Errors

The Port Errors screen can help to debug communications channel issues: Parity, Break, and Framing indicate mismatched port settings or, in the case of Break, incorrect cabling.

Using the iVu Command Channel Sample Application or a Terminal Program for Testing

The easiest way to test that the iVu command channel is correctly receiving and transmitting data is to use either the iVu Command Channel Sample App (available on the installation CD) or to use a terminal program running on a PC:

If using a terminal program, in the terminal program's configuration:

- Set new-line transmit to <CR><LF> (and set the end-of-frame delimiters on the iVu to match).
- Enable local echo.
- Set the Serial port set up so that the PC port number's baud rate, data, parity, and stop bits match those setup on the iVu.

Verifying Basic Receive Functionality

To verify the iVu can receive request frames from the requesting device:

1. On the iVu Sensor, go to the Main Menu > System > Communications > Serial I/O > Port Status screen.



2. On the requesting device, transmit one or more bytes to the iVu sensor.
 - If the data byte values appear correct and the number sent by the requesting device matches the number received by the iVu sensor, then the transmit/receive functionality is working properly.
 - If the connection is incorrect (electrically) or if the baud rate is mismatched, no bytes will appear in the upper field on the Port Status screen.
 - If the connection is correct (electrically), bytes will appear in the upper field of the Port Status screen in the order they were received.
 - If the Port Status: Errors at the bottom of the Port Status screen highlights red, then the connection is correct electrically but there is likely a settings mismatch between the iVu sensor and the requesting device. Verify the settings on both devices.
 - If the bytes appear with no errors but appear incorrect or there are too many or too few, then the port settings (for example, baud rate) are likely mismatched in a way that does not generate serial hardware errors. Verify the settings on both devices match exactly.

Verifying Basic Transmit Functionality

The iVu command channel will only send response frames to the requesting device if it receives a valid end-of-frame delimiter from the requesting device. To verify transmit functionality:

1. Transmit an end-of-frame delimiter sequence from the requesting device to the iVu sensor. For example, in a terminal program, simply hit Enter.

If a valid end-of-frame delimiter is received, the iVu sensor will immediately transmit a short error message back to the requesting device (for example, ERROR 10000_COMMAND_MISSING).

2. Verify that the number of bytes sent by the requesting device are the same as the number shown in the lower field of the Port Status screen on the iVu sensor. Go to the Main Menu > System > Communications > Serial I/O > Port Status screen.



3. If the byte count does not match, re-verify that the settings on both devices match exactly. If no bytes are received, re-check the wiring.

If the correct response frame is received, then basic electrical and port settings are correct.

6.5 Command Channel Primer

6.5.1 Command Channel Commands

All iVu command channel request command frames use the following syntax:

```
>> command group item value<EOF>
```

Notes

<EOF> is the end-of-frame delimiter. See below for a description.
All commands are in ASCII and are case-insensitive

command

An action to be performed on a particular iVu group; for example, get, set, do, login, or logout.

group

Identifies the iVu group that the command should act upon; for example, info, system, trigger, or bcr_input.

item

Further qualifies the action by specifying an item within the identified group; for example, comparedata or status.

value

For set commands, this identifies the data that must be set for the specified group item.

Note: Item is not used with get commands.

<EOF>

Identifies the end-of-frame for the command so that the iVu knows to begin processing. The iVu will return a response that includes the end-of-frame delimiter. The options for the <EOF> are set in the iVu Serial I/O menu, and are as follows:

- <comma>
- <colon>
- <semicolon>
- <CR>
- <CR><LF>
- <LF><CR>
- <ETX>



NOTE: When data is displayed on iVu screens such as the Port Status screen, printable delimiters are displayed as expected. Non-printable characters, such as <CR> are displayed in hex notation (\x0D).

Command Flow

The command flow should be such that a new command request should not be issued until the iVu command channel acknowledges the previous command request.

For example, the following is a series of command requests and responses. The first request sets the trigger mode to command and, once the sensor responds with an "OK," the next command request is issued to do (or execute) the trigger.

```
>> set trigger mode command\x0D\x0A
<< OK\x0D\x0A
>> do trigger\x0D\x0A
<< OK\x0D\x0A
```

String Delimiters and Escaping

By default setting, all strings used in commands are enclosed in quotation marks (""). All text in quotes is part of the command. Quotes (") or back-slashes (\) that are part of the string must be escaped with a back-slash. For example:

```
"abc\"def\"ghi\"jkl"
```

Set the String Delimiter parameters to 'None' if strings should not be enclosed in quotation marks.

Command Channel Command Synopsis

There are a number of general types of commands to do, set, and get sensor data.

Command Channel Response Frames

The iVu responds to all request frames with one or two responses depending on the type of command.

Do commands

All do commands are followed by one response that identifies the command status. For example:

```
>> do trigger\x0D\x0A
<< OK\x0D\x0A
```

Get commands

All get commands are followed by two responses: the first identifies the status of the command, and the second contains the retrieved information. For example:

```
>> get bcr_input comparedata\x0D\x0A
<< OK\x0D\x0A
<< "012345ABCDEF"\x0D\x0A
```

Set commands

All set commands are followed by one response that identifies the command status. For example:

```
>> set bcr_input comparedata "012345ABCDEF"\x0D\x0A
<< OK\x0D\x0A
```

Command Channel Command Status

The command status is either OK or ERROR. If OK, then the command has fully and successfully completed. If an error is returned it is in the form *ERROR nnnnn_ERROR_IDENTIFIER* (for example ERROR 10001_COMMAND_NOT_RECOGNIZED). Refer to [Command Channel Error Codes](#) on page 74 for a list of errors.

6.5.2 Conventions Used for Examples

There are a number of command channel examples included here, and the following are the conventions used in the examples:

- All examples use <CR><LF> for the end-of-frame delimiter, and this delimiter is always denoted in hex (\x0D\x0A) since that is what is displayed in the iVu logs and, for example, the Port Status screen.
- All commands are in bold text.
- For each example, a command request to the iVu sensor is prefaced with a >>, and a command response frame from the iVu sensor is prefaced by a << as shown below. These are only used to make the documentation clearer.

```
>> get info companyname\x0D\x0A
<< OK\x0D\x0A
<< "Banner Engineering Corp."\x0D\x0A
```

6.5.3 Examples

How to Trigger the Sensor and Retrieve Barcode Data using the Command Channel

To trigger the sensor and retrieve barcode data, do the following:

1. Go to the Main Menu > System > Sensor Configuration > Serial I/O.
2. Click on the Channel Mode button.
3. In the Channel Mode dialog, select Command from the drop-down list.

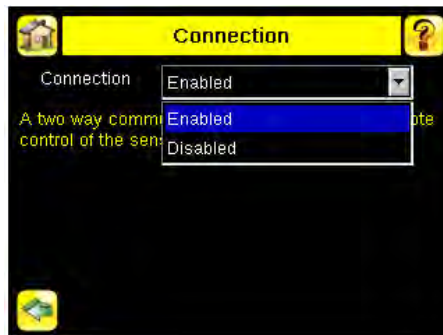

4. Set Trigger to Command. Go to the Main Menu > Imager > Trigger screen, and from the drop-down select Command
5. Issue a trigger command as follows:

```
>> do trigger\x0D\x0A
<< OK\x0D\x0A
```

6. Check that the inspection passed.

```
>> get inspection status\x0D\x0A
<< OK\x0D\x0A
<< Pass\x0D\x0A
```

7. Get the barcode data read by the iVu sensor.

```
>> get bcr_result\x0D\x0A
<< OK\x0D\x0A
<< "0043000011201"\x0D\x0A
```

How to Modify Barcode Compare Data Using the Command Channel

1. Go to the Main Menu > System > Sensor Configuration > Serial I/O.
2. Click on the Channel Mode button.
3. In the Channel Mode dialog, select Command from the drop-down list.



4. Set Trigger to Command. Go to the Main Menu > Imager > Trigger screen, and from the drop-down select Command.
5. Set the compare data.

```
>> set bcr_input comparedata "0043000011201"\x0D\x0A
<< OK\x0D\x0A
```

6. Trigger the sensor.

```
>> do trigger\x0D\x0A
<< OK\x0D\x0A
```

7. Check that the inspection passed.

```
>> get inspection status\x0D\x0A
<< OK\x0D\x0A
<< Pass\x0D\x0A
```

8. Get the barcode data read by the iVu sensor.

```
>> get bcr_result data\x0D\x0A
<< OK\x0D\x0A
<< "0043000011201"\x0D\x0A
```

6.5.4 Command Channel Reference

Info Command Group

| Command | Group | Item | Description |
|---------|-------|--------------------|---|
| Get | Info | CompanyName | The company name as a string. |
| Get | Info | ModelNumber | The sensor model number as a string. |
| Get | Info | FirmwareVersion | The sensor firmware version as a string. |
| Get | Info | SerialNumber | The sensor serial number as a string. |
| Get | Info | Name | The sensor name as a string. |
| Get | Info | BootNumber | The number of sensor bootups. |
| Get | Info | UpTimer | The elapsed time the sensor has been running in the format hh:mm:ss:msec. |
| Get | Info | HourCount | The number of hours the sensor has been running. |
| Get | Info | RemoteConnected | The remote display connected status as a boolean value (true or false). |
| Get | Info | RemoteModelNumber | The model number of the remote display as a string. |
| Get | Info | RemoteSerialNumber | The serial number of the remote display as a string. |

Examples

```
>> get info companyname\x0D\x0A
<< OK\x0D\x0A
<< "Banner Engineering Corp."\x0D\x0A
```

```
>> get info bootnumber\x0D\x0A
<< OK\x0D\x0A
<< 42\x0D\x0A
```

```
>> get info uptimer\x0D\x0A
<< OK\x0D\x0A
<< 4:42:42:324\x0D\x0A
```

System Command Group

| Command | Group | Item | Description |
|---------|----------|------------|--|
| Do | System | Reboot | Reboots the sensor. Pre-empts other commands except Save. |
| Do | System | Save | Saves inspection and configuration parameters. Blocks until finished. Should be used sparingly. |
| Get | Ethernet | IPAddress | Get the current active IP address of the sensor as a string. |
| Get | Ethernet | SubnetMask | Get the current active subnet mask of the sensor as a string. |
| Get | Ethernet | Gateway | Get the current active Gateway address of the sensor as a string. |
| Set | Ethernet | IPAddress | Set IP address of the sensor. A valid IP address must be supplied as a string (for example: 192.168.0.1). A 'Reboot' command from the command channel must follow in order to make the new IP address effective. You may also set new Subnet Mask and Gateway address as required before a 'Reboot' command is sent to the sensor. |
| Set | Ethernet | SubnetMask | Set new subnet mask. A 'Reboot' command is required to be sent from the command channel in order to make the new mask effective. |
| Set | Ethernet | Gateway | Set new Gateway IP address. A 'Reboot' command is required to be sent from the command channel to make the new address effective. |

Examples

```
>> do system save\x0D\x0A
<< OK\x0D\x0A
```

Status Command Group

| Command | Group | Item | Description |
|---------|--------|------------------|--|
| Get | Status | Ready | Flag indicating whether the system is ready to trigger (true) or busy (false). |
| Get | Status | SystemError | Flag indicating whether a system error is active (true) or cleared (false). |
| Do | Status | ClearSystemError | Clears the system error LED and sets the internal flag to false. |

Examples

```
>> get status ready\x0D\x0A
<< OK\x0D\x0A
<< True\x0D\x0A
```

```
>> get status systemerror\x0D\x0A
<< OK\x0D\x0A
<< False\x0D\x0A
```

```
>> do status clearsystemerror\x0D\x0A
<< OK\x0D\x0A
```

Trigger Command Group

| Command | Group | Item | Description |
|---------|---------|------------|---|
| Get | Trigger | Mode | The sensor's triggering mode. This value must match the modes supported by the sensor. This value can be modified using the sensor's touchscreen. This remotely modified value is not persisted to the sensors permanent memory. The 'Save' operation is required to persist this value. |
| Set | Trigger | Mode | The sensor's triggering mode. This value must match the modes supported by the sensor. This value can be modified using the sensor's touchscreen. This remotely modified value is not persisted to the sensors permanent memory. The 'Save' operation is required to persist this value. |
| Do | Trigger | Immediate | This command initiates a single trigger and inspection. The sensor does not transmit a response until the sensor has completed the action and returned to the READY state. This command requires the 'Command' trigger mode. The sensor must be in the ready state to perform the desired operation. |
| Do | Trigger | Gated | This command initiates the gated triggering mode. Images are repeatedly acquired until a valid object is detected or this mode is aborted. The sensor does not transmit a response until the sensor has completed the action and returned to the READY state. This command requires the 'Command' trigger mode. The sensor must be in the ready state to perform the desired operation. |
| Do | Trigger | AbortGated | This command aborts the gated triggering mode. The sensor does not transmit a response until the gated triggering option has been aborted and the sensor has returned to the READY state. This command requires the 'Command' trigger mode. |

Imager Command Group

| Command | Group | Item | Description |
|---------|--------|------|--|
| Get | Imager | Gain | The sensor's value used to electronically brighten all image pixels. This value can be modified using the sensor's touchscreen. This remotely modified value is not persisted to the sensors permanent memory. The 'Save' operation is required to persist this value. |

| Command | Group | Item | Description |
|---------|--------|----------|---|
| Set | Imager | Gain | The sensor's value used to electronically brighten all image pixels. This value can be modified using the sensor's touchscreen. This remotely modified value is not persisted to the sensor's permanent memory. The 'Save' operation is required to persist this value. |
| Get | Imager | Exposure | The sensor's value used to control the amount of time the imager is allowed to gather light for the image. This value can be modified using the sensor's touchscreen. This remotely modified value is not persisted to the sensor's permanent memory. The 'Save' operation is required to persist this value. |
| Set | Imager | Exposure | The sensor's value used to control the amount of time the imager is allowed to gather light for the image. This value can be modified using the sensor's touchscreen. This remotely modified value is not persisted to the sensor's permanent memory. The 'Save' operation is required to persist this value. |

Examples

```
>> get imager exposure\x0D\x0A
<< OK\x0D\x0A
<< Command\x0D\x0A
```

```
>> set imager exposure"11900"\x0D\x0A
<< OK\x0D\x0A
```

Teach Command Group

| Command | Group | Item | Description |
|---------|-------|-------------|---|
| Do | Teach | NextTrigger | This command forces the sensor to perform the Remote Teach operation on the next trigger. This command can be performed using the sensor's touchscreen. |

Examples

```
>> do teach\x0D\x0A
<< OK\x0D\x0A
```

ProductChange Command Group

| Command | Group | Item | Description |
|---------|---------------|-----------------|---|
| Do | ProductChange | [Name] | Forces the sensor to switch to the specified inspection. The sensor does not transmit a response until the sensor has completed the action. Inspections results will be invalid until the next trigger. |
| Get | ProductChange | InspectionNames | List of all inspections stored in the sensor. |

Examples

```
>> get productchange inspectionnames\x0D\x0A
<< OK\x0D\x0A
```

```
>> do productchange "inspection2"\x0D\x0A
<< OK\x0D\x0A
```

History Command Group

| Command | Group | Item | Description |
|---------|---------|-------------------|--|
| Get | History | Passed | This value indicates the number of passed inspections for the active inspection. This value is cleared (reset) whenever history is cleared. This value is cleared (reset) when the device starts up or is rebooted. |
| Get | History | Failed | This value indicates the number of failed inspections for the active inspection. This value is cleared (reset) whenever history is cleared. This value is cleared (reset) when the device starts up or is rebooted. |
| Get | History | MissedTriggers | This value indicates the number of missed triggers for the active inspection. This value is cleared (reset) whenever history is cleared. This value is cleared (reset) when the device starts up or is rebooted. |
| Get | History | StartFrameNumber | This value indicates the starting frame number for the active inspection. This value is cleared (reset) whenever history is cleared. This value is cleared (reset) when the device starts up or is rebooted. |
| Get | History | EndFrameNumber | This value indicates the latest frame number for the active inspection. This value is cleared (reset) whenever history is cleared. This value is cleared (reset) when the device starts up or is rebooted. |
| Get | History | TotalFrames | This value indicates the total number inspections (frames) for the active inspection. This value is cleared (reset) whenever history is cleared. This value is cleared (reset) when the device starts up or is rebooted. |
| Get | History | MinInspectionTime | This value indicates the minimum (fastest) inspection time for the active inspection. This value is cleared (reset) whenever history is cleared. This value is cleared (reset) when the device starts up or is rebooted. |
| Get | History | MaxInspectionTime | This value indicates the maximum (slowest) inspection time for the active inspection. This value is cleared (reset) whenever history is cleared. This value is cleared (reset) when the device starts up or is rebooted. |
| Get | History | MinBarcodeCount | This value indicates the minimum number of barcodes read for the active inspection. This value is cleared (reset) whenever history is cleared. This value is cleared (reset) when the device starts up or is rebooted. |
| Get | History | MaxBarcodeCount | This value indicates the maximum number of barcodes read for the active inspection. This value is cleared (reset) whenever history is cleared. This value is cleared (reset) when the device starts up or is rebooted. |
| Do | History | Clear | This command clears all history fields for the active inspection. History values include pass count, fail count, execution times and sensor specific history values. This command can be performed using the sensor's touchscreen. |

Examples

```
>> get history passed\x0D\x0A
<< OK\x0D\x0A
<< 13\x0D\x0A
```

```
>> get history startframenumber\x0D\x0A
<< OK\x0D\x0A
<< 3\x0D\x0A
```

```
>> do history clear\x0D\x0A
<< OK\x0D\x0A
```

Inspection Command Group

| Command | Group | Item | Description |
|---------|------------|--------|---|
| Get | Inspection | Status | This status of the most recent inspection either Pass, Fail, or Idle (no triggers). |
| Get | Inspection | Name | The name of the active inspection. |

| Command | Group | Item | Description |
|---------|------------|---------------|--|
| Get | Inspection | FrameNumber | The most recent inspection frame number. |
| Get | Inspection | ExecutionTime | The most recent inspection execution time in msec. |

Examples

```
>> get inspection status\x0D\x0A
<< OK\x0D\x0A
<< Fail\x0D\x0A
```

```
>> get inspection executiontime\x0D\x0A
<< OK\x0D\x0A
<< 37.739\x0D\x0A
```

BCR_INPUT Command Group

| Command | Group | Item | Description |
|---------|-----------|-------------|--|
| Get | BCR_INPUT | CompareData | The Barcode inspection compare data string. This string must start and end with the double quote character. This value can be modified using the sensor's touchscreen. This remotely modified value is not persisted to the sensors permanent memory. The 'Save' operation is required to persist this value. |
| Set | BCR_INPUT | CompareData | The Barcode inspection compare data string. This string must start and end with the double quote character. This value can be modified using the sensor's touchscreen. This remotely modified value is not persisted to the sensors permanent memory. The 'Save' operation is required to persist this value. |
| Get | BCR_INPUT | CompareMask | The Barcode inspection compare string mask in binary format; that is, masked characters are indicated by a "1" and unmasked characters are "0." Note that the mask character string must match the length of the compare string. This value can be modified using the sensor's touchscreen. This remotely modified value is not persisted to the sensors permanent memory. The 'Save' operation is required to persist this value. |
| Set | BCR_INPUT | CompareMask | The Barcode inspection compare string mask in binary format; that is, masked characters are indicated by a "1" and unmasked characters are "0." Note that the mask character string must match the length of the compare string. This value can be modified using the sensor's touchscreen. This remotely modified value is not persisted to the sensors permanent memory. The 'Save' operation is required to persist this value. |

BCR_RESULT Command Group

| Command | Group | Item | Description |
|---------|------------|-------|--|
| Get | BCR_RESULT | Count | The total number of barcodes found. The most recent inspection value is used. Access to this value requires a valid trigger. |
| Get | BCR_RESULT | Data | The decoded barcode data strings. Each string starts and ends with the double quote character. Multiple values are separated by the field delimiter The most recent inspection value is used. Access to this value requires a valid trigger. |
| Get | BCR_RESULT | Type | The decoded barcode symbol type(s). Multiple values are separated by the field delimiter The most recent inspection value is used. Access to this value requires a valid trigger. |

BCR_HISTORY Command Group

| Command | Group | Item | Description |
|---------|-------------|----------|--|
| Get | BCR_HISTORY | MinCount | This value indicates the minimum number of barcodes read for the active inspection. This value is cleared (reset) whenever history is cleared. This value is cleared (reset) when the device starts up or is rebooted. |
| Get | BCR_HISTORY | MaxCount | This value indicates the maximum number of barcodes read for the active inspection. This value is cleared (reset) whenever history is cleared. This value is cleared (reset) when the device starts up or is rebooted. |

6.5.5 Command Channel Command Status Register

The command status is a verification of the command type.

| Command Status | Value (16-bit integer) |
|----------------|------------------------|
| Unknown | 0 |
| Read | 1 |
| Write | 2 |
| Execute | 3 |

6.5.6 Command Channel Error Codes

Table 7: Plus BCR Command Channel Error Codes

| Numeric ID | Text ID | Description |
|------------|------------------------|---|
| 00000 | SUCCESS | Command processed successfully |
| 10000 | EMPTY_FRAME_RECEIVED | Indicates that the request was empty. The command channel requires a command, any arguments, and an end-of-frame delimiter. |
| 10001 | COMMAND_NOT_RECOGNIZED | The command specified is not recognized |
| 10100 | GROUP_MISSING | A Group ID must be specified immediately after the command |
| 10101 | GROUP_NOT_FOUND | The specified Group ID is invalid / unknown |
| 10102 | GROUP_ITEM_MISSING | A Group Item ID must be specified immediately after the Group ID |
| 10103 | GROUP_ITEM_NOT_FOUND | The specified Group Item ID is invalid / unknown |
| 10152 | NOT_READABLE | Attempt to get a value that is not readable |
| 10153 | NOT_WRITEABLE | Attempt to set a value that is not writeable |
| 10250 | NOT_A_METHOD | Method ID specified is not a method |
| 10251 | WRONG_ARGUMENT_COUNT | Total method arguments specified do not match method |
| 10252 | COMMAND_NOT_FINISHED | Attempt to issue command when a previous command has not finished |
| 10300 | INVALID_ARGUMENT_TYPE | Item ID specified must be a item (not a group or method) |
| 10301 | DATA_VALUE_MISSING | Command missing item's data value |
| 10350 | ARGUMENTS_DETECTED | Get command received with unneeded arguments |
| 10351 | INVALID_ARGUMENT_TYPE | Item ID specified must be a item (not a group or method) |
| 10340 | MINIMUM_VALUE_EXCEEDED | New item value is below the minimum |
| 10341 | MAXIMUM_VALUE_EXCEEDED | New items value is above the maximum |
| 10500 | DATA_SET_EMPTY | Data export operation returned no results. |
| 10900 | SENSOR_NOT_READY | Command specified requires sensor to be in the READY state. |

| Numeric ID | Text ID | Description |
|------------|------------------------------|--|
| 10920 | SENSOR_TYPE_NOT_ACTIVE | Command specified belongs to a different sensor type. |
| 15000 | VALUE_INVALID | Text value is invalid / unknown |
| 15050 | VALUE_INVALID | Text value is invalid - expecting True or False |
| 15100 | STRING_TOO_LONG | String value specified exceeds maximum allowable length |
| 20000 | BARCODE_TIMEOUT | Attempt to obtain Barcode result data when decoder has timed out |
| 20001 | NO_BARCODES_FOUND | Attempt to obtain Barcode result data when no barcodes were found |
| 20002 | COMPARE_DATA_DISABLED | Operation requires Barcode compare to be enabled |
| 20003 | COMPARE_MASK_INVALID | Compare mask invalid. Expecting string of 1's and 0's with length equal to compare data string |
| 20004 | NUMBER_TO_FIND_NOT_ONE | Barcode number to find must be set to one for this operation. |
| 80000 | REMOTE_DISPLAY_NOT_CONNECTED | Remote Display must be connected to obtain this value |
| 80001 | REMOTE_DISPLAY_NOT_SUPPORTED | This sensor does not have Remote Display capability |
| 80100 | COMMAND_MODE_EXPECTED | The Trigger Mode must be set to "Command" perform this operation |
| 80101 | COMMAND_TIMED_OUT | The command timed out before finishing |
| 80102 | TRIGGER_REQUIRED | Access to the specified data requires a triggered inspection |
| 80103 | TRIGGER_NOT_GATED | Command requires a active Gated Trigger |
| 80150 | COMMAND_TIMED_OUT | The command timed out before finishing |
| 80200 | SYSTEM_ERROR_NOT_ACTIVE | The System Error must be active to execute this command |

6.6 iVu Discovery Protocol

The iVu Discovery Protocol is a method by which Banner's iVu Vision sensors can be dynamically discovered on an Ethernet network.

6.6.1 Overview

The iVu Discovery Protocol is a method to dynamically discover Banner's iVu Vision sensors on an Ethernet network. The goal is to both be able to find a sensor and then if necessary change the IP address of that sensor so that it is on the same subnet as the controlling PC. This is done without requiring the PC to change its IP address or using anything more than an Ethernet cable connected to the sensor.

The iVu Discovery Protocol is implemented using UDP broadcast packets that are mapped to Ethernet Broadcast packets by the TCP/IP stack. Broadcast packets are the only mechanism that ensures delivery of the data if the sensor and controlling PC are configured for different subnets and on the same bridged Ethernet network. The contents of the packets used for Banner's iVu Vision systems are proprietary.

The iVu Discovery Protocol is supported by iVu Vision sensors from the 2012R1 or later releases.

6.6.2 UDP Usage

The packets are all sent with the source and destination port number set to 19995.

The destination IP address is always set to a broadcast value of 255.255.255.255.

6.6.3 Packet Format

The packets used by the Discovery Protocol all follow the same general format. The packets have a short header and a larger body area with ASCII text.

Header Format

The header of the packets is as follows:

| Name | Offset | Length (bytes) | Description |
|-----------------|--------|----------------|---|
| Protocol ID | 0 | 4 | Magic number that identifies this as a Discovery Protocol Packet. If the protocol changes and the same port number is used, this value should also change. Always set to 0x6956752b. This appears as "iVu+" when viewed with packet dump software. |
| Message Type | 4 | 4 | Identifies the type of message: DISCOVER = 0x44495343 - dumps as "DISC" DISCOVER_REPLY = 0x52504c59 – dumps as "RPLY" DISCOVER_SETIP = 0x53455449 – dumps as "SETI" See below for a detailed description of each of these messages. |
| Correlation Tag | 8 | 4 | A number chosen by the sender of a DISCOVER packet. The value sent in a DISCOVER packet is returned in the DISCOVER_REPLY packet. This allows the sender to match its requests with responses it receives. |

Body Format

The Body of the packet follows the header and consists of a long string of ASCII text. The ASCII text section contains a number of strings in the format of "<name>=<value>," Those names and values are detailed below. Please note that the comma is required, and is used as a string separator.

| Name | Values | Description |
|--------------|--|---|
| SerialNumber | String | Sensor serial number |
| Version | String | Firmware version string. |
| Name | String | Name of the sensor as ASCII string. This field is filled in only if the sensor is configured for English language. For all other languages, this field will be omitted. |
| MAC | xx:xx:xx:xx:xx:xx – Each 'x' is a hexadecimal character. | Ethernet MAC address of this sensor |
| IP | String in decimal dot notation | IP address of the sensor |
| NetMask | String in decimal dot notation | Network mask of the sensor |
| Gateway | String in decimal dot notation | IP address of the sensor's default gateway |

DISCOVER Message

The packet with Discover message is sent by a controlling PC to find which sensors are present on its network. The DISCOVER message should broadcast on all Ethernet interfaces of the controlling PC. After sending the DISCOVER message packet, the PC should wait to receive DISCOVER_REPLY packets from the sensors.

The controlling PC does not 'know' how many sensors are connected therefore it should wait for up to 5 seconds for any reply packets to come to it to allow for any variation in time needed for the sensors to reply.

It is recommended that more than one DISCOVER packet is sent because a single UDP packet may be lost by network switches or the camera. The probability of multiple packets being lost is much smaller. These packets should be separated in time by 100 milliseconds or more.

This and the following packet capture examples were done using a freely-available network tracing and troubleshooting software called Wireshark. Banner Engineering Corporation does not provide support for this product nor endorses it.

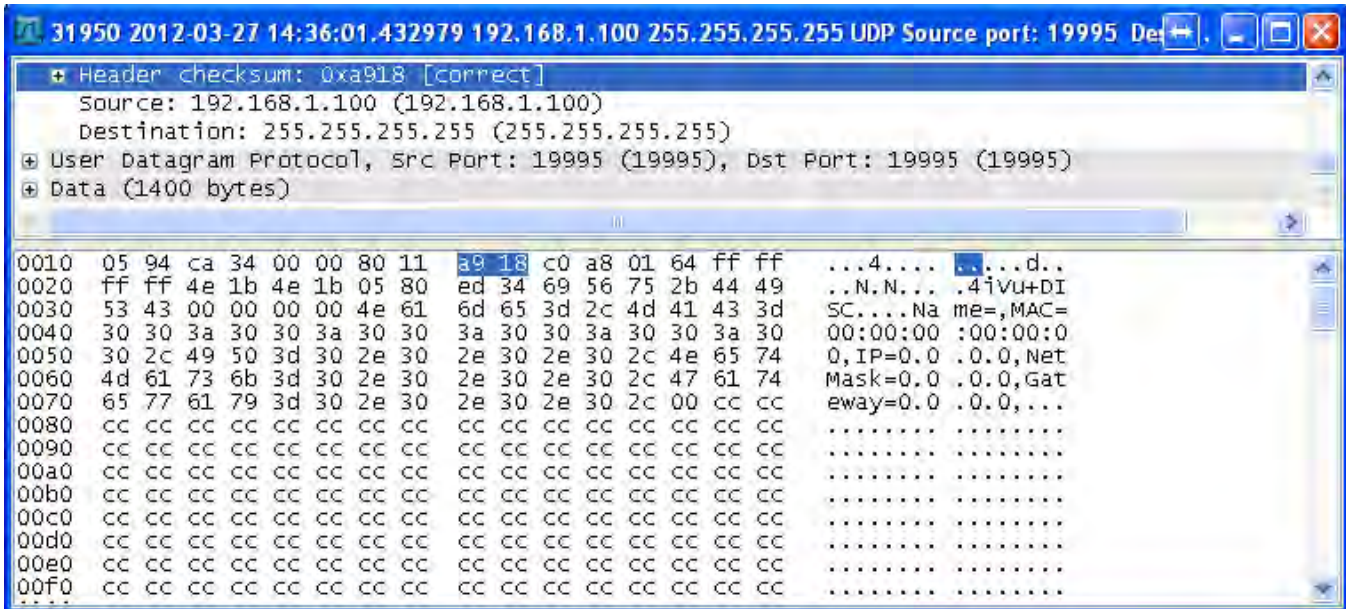

NOTE: – In some situations, it is possible for a PC to receive a copy of the packet it sent. This condition is subject to the operating system and/or network configuration. If received, such a received packet should be detected (by checking the message type) and discarded.

In this example for the Discover packets, empty sections for Name, MAC, IP, NetMask and Gateway are shown. These empty fields in the Discover packet are not necessary and are an artifact of the application used to test the iVu Discovery Protocol

DISCOVER_REPLY Message

The DISCOVER_REPLY packet is sent by the sensor in reply to a DISCOVER message. For the body portion of the message it will contain all of the parameters detailed above.

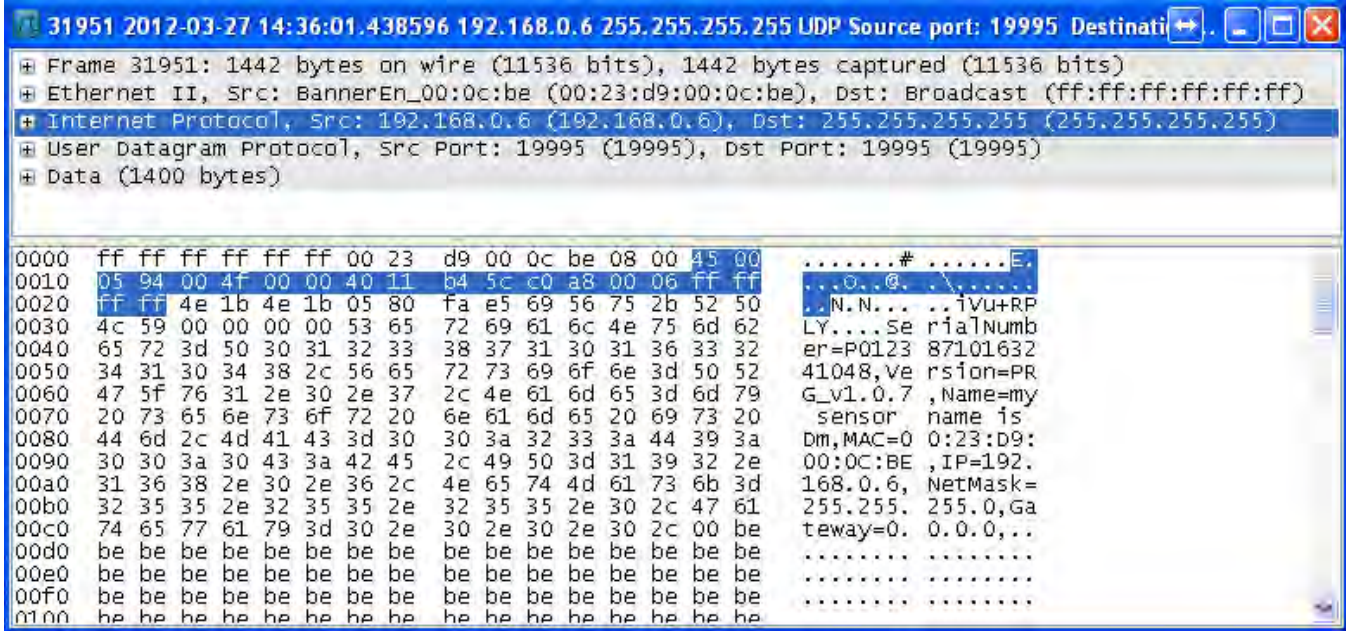

NOTE: In some situations, a network switch/router will receive a broadcast packet and duplicate it. This will result in the controlling PC receiving multiple responses that are completely identical. This can be handled by discarding multiple replies that have the same correlation tag.

DISCOVER_SETIP Message

The DISCOVER_SETIP message is sent by the controlling PC to instruct a sensor to change its IP address, subnet mask and default gateway. The message sent by the PC must always have the following parameters in the body portion:

Either MAC or SerialNumber or both. If both are present, the match will be performed on both fields.

- IP
- NetMask
- Gateway

Any other parameters in the body will be ignored by the sensor.

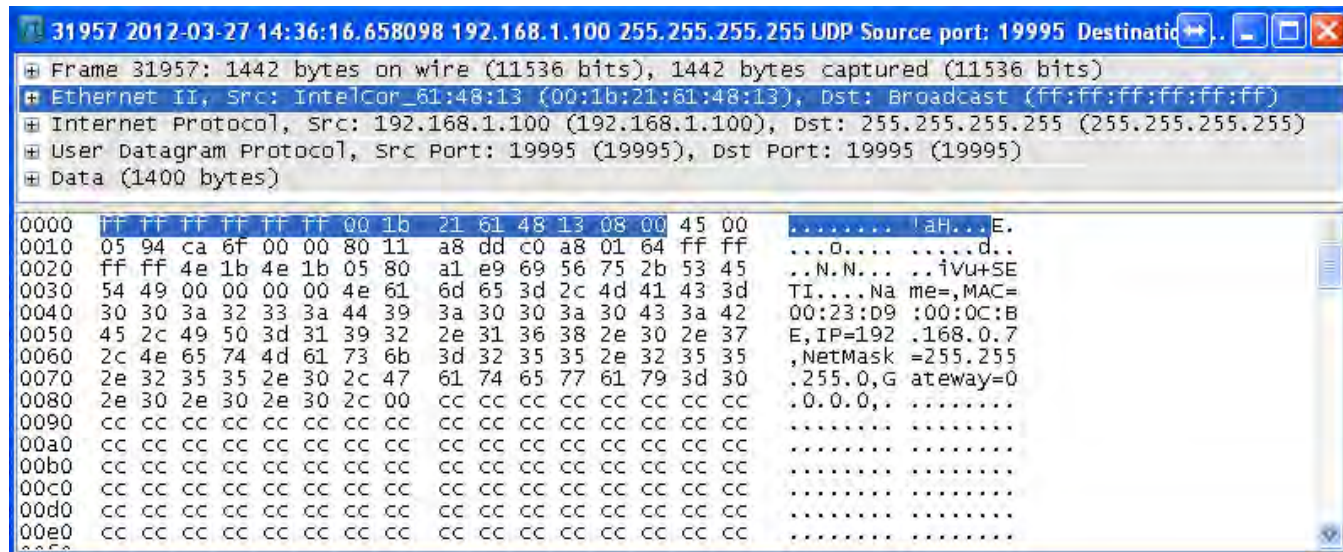

When the sensor receives a DISCOVER_SETIP message, the following actions are performed:

1. The sensor will first compare the specified MAC address, the SerialNumber, or both, if both are present, with its own.
 - 2a. If the above field(s) does not match the sensor's equivalent, the sensor will discard the packet.
 - No reply will be generated
 - 2b. If the match is detected:

The sensor will compare the new values with the current values

- If the new values are the same as the current values, the sensor will discard the packet
- No further reply will be generated

The sensor will set its IP address, subnet mask and default gateway to match what is in the packet.

- The sensor will perform only syntactic checks on the supplied data. It will not perform gateway presence or duplicate IP address checks.
 - > The change will be logged in iVu system log as a success
 - > A DISCOVER_REPLY packet will be sent by the sensor back to the request originator
 - > The sensor will reboot in approximately 1 second

```

31959 2012-03-27 14:36:16.665180 192.168.0.6 255.255.255.255 UDP Source port: 19995 Destination:
+ Frame 31959: 1442 bytes on wire (11536 bits), 1442 bytes captured (11536 bits)
+ Ethernet II, Src: BannerEn_00:0c:be (00:23:d9:00:0c:be), Dst: Broadcast (ff:ff:ff:ff:ff:ff)
+ Internet Protocol, Src: 192.168.0.6 (192.168.0.6), Dst: 255.255.255.255 (255.255.255.255)
+ User Datagram Protocol, Src Port: 19995 (19995), Dst Port: 19995 (19995)
+ Data (1400 bytes)
0000  ff ff ff ff ff 00 23 d9 00 0c be 08 00 45 00  .....# .....E.
0010  05 94 00 51 00 00 40 11 b4 5a c0 a8 00 06 ff ff  ...Q..@. .Z.....
0020  ff ff 4e 1b 4e 1b 05 80 a1 3e 69 56 75 2b 52 50  ..N.N... .>iVu+RP
0030  4c 59 00 00 00 00 53 65 72 69 61 6c 4e 75 6d 62  LY...Se rialNumb
0040  65 72 3d 50 30 31 32 33 38 37 31 30 31 36 33 32  er=P0123 87101632
0050  34 31 30 34 38 2c 56 65 72 73 69 6f 6e 3d 50 52  41048, Ve rsion=PR
0060  47 5f 76 31 2e 30 2e 37 2c 4e 61 6d 65 3d 6d 79  G_v1.0.7 ,Name=my
0070  20 73 65 6e 73 6f 72 20 6e 61 6d 65 20 69 73 20  sensor name is
0080  44 6d 2c 4d 41 43 3d 30 30 3a 32 33 3a 44 39 3a  Dm,MAC=0 0:23:D9:
0090  30 30 3a 30 43 3a 42 45 2c 49 50 3d 31 39 32 2e  00:0C:BE ,IP=192.
00a0  31 36 38 2e 30 2e 37 2c 4e 65 74 4d 61 73 6b 3d  168.0.7, NetMask=
00b0  32 35 35 2e 32 35 35 2e 32 35 35 2e 30 2c 47 61  255.255. 255.0,Ga
00c0  74 65 77 61 79 3d 30 2e 30 2e 30 2e 30 2c 00 be  teway=0. 0.0,..
00d0  be be be be be be be be be be be be be be be be  .....
00e0  be be be be be be be be be be be be be be be be  .....
00f0  be be be be be be be be be be be be be be be be  .....
0100  be be be be be be be be be be be be be be be be  .....

```

6.6.4 Message Flow

Below are some examples of typical message flows for various interactions with the sensor.

Discovery of a Sensor

1. PC broadcasts a DISCOVER message

Only the header values need to be filled

- Protocol ID field should be set to 0x6956752b, "iVu+"
- Message Type field should be set to 0x44495343, "DISC"
- Correlation tag should be set by the sender to the non-zero value that will allow the sender to identify the response.

The packet with the header values is sent out using the broadcast address of 255.255.255.255



NOTE: Not all the switches are configured to pass broadcast packets by default. A switch configuration change may be necessary to enable the passing of broadcast packets.

2. Upon receipt of the broadcast message the sensor performs the following:

Sensor verifies that the message is addressed to it by comparing Protocol ID field to value 0x6956752b.

- If the value matches, the sensor examines the Message Type field.
 - > If the value does not match any of the commands, the sensor discards the packet.
 - > If the Message Type field matches 0x44495343, "DISC", the sensor prepares the response in the form of DISCOVER_REPLY packet:
 - Protocol ID field is again set to 0x6956752b, "iVu+"
 - Message Type field is set to 0x52504c59, "RPLY"
 - Correlation Tag is copied from the received message
 - Body of the message is populated with the following fields, with fields separated by a comma:

- SerialNumber ("SerialNumber=P01238710163241048")
- Version ("Version=TB_v1.1.4")
- Name ("Name=Sensor1")
- MAC ("MAC=00:11:22:33:44:55")
- IP ("IP=192.168.0.1")
- NetMask ("NetMask=255.255.255.0")
- Gateway ("Gateway=0.0.0.0")

The body of the message will look like this:

SerialNumber=P01238710163241048,Version=TB_v1.1.4,Name=Sensor1,MAC=00:11:22:33:44:55,IP=192.168.0.1,NetMask=255.255.255.0,Gateway=0.0.0.0

- The packet is broadcast on the network to port 19995. The sensor uses a pseudo-random back-off time to minimize collisions with other sensors.

Change IP Address of a Sensor Using the MAC

1. PC broadcasts a DISCOVER_SETIP message

The header values are filled as follows:

- Protocol ID field must be set to 0x6956752b, "iVu+"
- Message Type field should be set to 0x53455449, "SETI"
- Correlation tag must be set by the sender to a non-zero value that will allow the originator to identify the response

The body of the message must be filled as follows:

- MAC ("MAC=00:11:22:33:44:55")
- IP ("IP=192.168.0.1")
- NetMask ("NetMask=255.255.255.0")
- Gateway ("Gateway=0.0.0.0")
- The body of the message will look like this:

MAC=00:11:22:33:44:55,IP=192.168.0.1,NetMask=255.255.255.0,Gateway=0.0.0.0

The packet must be sent out using the broadcast address of 255.255.255.255



NOTE: Not all the switches are configured to pass broadcast packets by default. A switch configuration change may be necessary to enable the passing of broadcast packets.

2. Upon receipt of the broadcast message the sensor performs the following:

Sensor verifies that the message is addressed to it by comparing Protocol ID field to value 0x6956752b, "iVu +".

- If the value matches, the sensor examines the Message Type field.
- If the Message Type field matches 0x53455449, "SETI", the sensor performs the following actions:
 - >The received MAC address is compared with the MAC address of the sensor.
- If the MAC address does not match, the packet is discarded
 - >No further replies or logs are generated
- If the received MAC address matches that of the sensor, the sensor performs the following actions:
 - > IP, NetMask, and Gateway addresses are extracted from the body of the message
 - > Values are verified to be syntactically correct
 - For example, Gateway address of 255.255.255.255 is not allowed
 - IP address of 0.0.0.0 or 255.255.255.255 is not allowed

- The check for duplicate IP address will not be performed
- > If the values do not pass the syntax check, the packet is discarded
 - The attempt is logged in the System Log
 - A DISCOVER_REPLY (RPLY) reply with current values is generated and sent. (please see Sensor Discovery for details)
- > If the values do pass the syntax check:
 - New values are stored in the sensor
 - The change is logged in the System Log
 - A DISCOVER_REPLY ("RPLY) reply with new values is generated and sent. (please see [iVu Discovery Protocol Message Flow Discovery of a sensor](#) for details)
 - The sensor is restarted.

Change IP Address of a Sensor Using the Serial Number

1. PC broadcasts a DISCOVER_SETIP message

The header values are filled as follows:

- Protocol ID field must be set to 0x6956752b, "iVu+"
- Message Type field should be set to 0x53455449, "SETI"
- Correlation tag must be set by the sender to a non-zero value that will allow the originator to identify the response
- The body of the message must be filled as follows:
 - SerialNumber ("SerialNumber=P01238710163241048")
 - IP ("IP=192.168.0.1")
 - NetMask ("NetMask=255.255.255.0")
 - Gateway ("Gateway=0.0.0.0")
 - The body of the message will look like this:

```
SerialNumber=P01238710163241048,IP=192.168.0.1,NetMask=255.255.255.0,Gateway=0.0.0.0
```

- The packet must be sent out using the broadcast address of 255.255.255.255



NOTE: Not all the switches are configured to pass broadcast packets by default. A switch configuration change may be necessary to enable the passing of broadcast packets.

2. Upon receipt of the broadcast message the sensor performs the following:

Sensor verifies that the message is addressed to it by comparing Protocol ID field to value 0x6956752b, "iVu+".

- If the value matches, the sensor examines the Message Type field
- If the Message Type field matches 0x53455449, "SETI", the sensor performs the following actions:
 - > The received SerialNumber is compared with the SerialNumber of the sensor.
 - If the received serial number does not match, the packet is discarded
 - No further replies or logs are generated
 - If the received serial number matches that of the sensor, the sensor performs the following actions:
 - IP, NetMask, and Gateway addresses are extracted from the body of the message
 - Values are verified to be syntactically correct

For example, Gateway address of 255.255.255.255 is not allowed

IP address of 0.0.0.0 or 255.255.255.255 is not allowed

The check for duplicate IP address will not be performed

- If the values do not pass the syntax check, the packet is discarded

The failed attempt is logged in the System Log

A DISCOVER_REPLY (RPLY) reply with current values is generated and sent. (please see [Sensor Discovery](#) for details)

- If the values do pass the syntax check:

New values are stored in the sensor

The change is logged in the System Log

A DISCOVER_REPLY ("RPLY) reply with new values is generated and sent. (please see [Sensor Discovery](#) for details)

The sensor is restarted.

7 Industrial Ethernet Overview

7.1 Device Setup

7.1.1 Set IP Address

When shipped, the device is assigned a default IP address - 192.168.0.1, a default Subnet Mask - 255.255.255.0, and a default gateway - 0.0.0.0. To change these defaults, click on Main Menu > System > Communications > Ethernet I/O.

7.1.2 Set Industrial Ethernet Protocol (EIP/Modbus/TCP/PCCC/PROFINET®)

The Industrial Ethernet communication channel is disabled by default. In order to enable this channel, click on Main Menu > System > Communications > Industrial Ethernet > Connection. Select the channel of interest (EIP, Modbus/TCP, PROFINET, or PCCC). Only one type of connection can be established at any given time.

Information about an established connection can be obtained from Main Menu > System > Communications > Industrial Ethernet > Status screen. Click on the connection of interest to view details.

This device provides extensive logging for the communication that occurs over the Industrial Ethernet connection. Logs can either be viewed from Main Menu > System > Communications > Industrial Ethernet > View Logs, or Main Menu > Logs > Communication Logs > Industrial Ethernet.

7.1.3 Set Trigger Mode

The sensor can be triggered using either the hardware trigger or through over the Industrial EtherNet. In order to only accept triggers generated through the Industrial EtherNet communication channel, click on the Main Menu > Imager > Trigger, and select Industrial EtherNet Only from the drop-down menu.

7.2 Supported Functions

The iVu Plus Series sensor is controlled over EtherNet/IP and Modbus/TCP using the input and output data it makes available as a slave device for those protocols.

Here are some of the Sensor operations that can be performed using input and output values:

- Product Change
- Teach Enable
- Trigger the sensor
- Read output indicators (pass/fail/ready/error)
- Read counters (pass, fail, system error, missed trigger, frame count, iteration count)
- Read iVu sensor results
- On Barcode, change compare string and its mask

7.2.1 iVu Input Values

The operation of the iVu Plus Series sensor can be controlled through input bits and commands.

Register/Input Coil Bits

The following commands can only be executed using bits:

| Input Coil Bit | Command | Description |
|----------------|----------------|--|
| 0 | Product Change | Execute a product change (inspection number specified in the "Product Change Number" 32-bit integer register). |
| 1 | Teach Latch | Latch a teach flag. Teach is executed on next trigger. |
| 2 | Trigger | Causes system to trigger an inspection if ready. |
| 3 | Gated Trigger | Causes system to start looking for requested barcodes (BCR products only) |
| 5 | Set BCR String | Sets barcode compare string (BCR products only) |
| 6 | Set BCR Mask | Sets masks for barcode compare string (BCR products only) |
| 15 | Command | Set this bit to 1 to execute the command entered in the Command ID Register. |

7.2.2 iVu Output Values

Using output values, the following information can be obtained:

- ACK bits (acknowledgement bits) for input commands, including error codes
- System indicators (Ready, Pass/Fail, Read/No Read, Output signals, Command Error, etc.)
- Inspection History (Iteration Count, Pass Count, Fail Count, etc.)
- Current Inspection Results (data of the sensor type contained in the inspection)
- Command Responses

Refer to the sections on protocols for more information.

ACK Flags

For each of the Command Flags there is a corresponding ACK flag. The Vision Sensor sets the ACK flag when the corresponding action is complete. Command flags cause actions to occur on the low-to-high transition of that flag. You must clear the command flag after the corresponding ACK flag has been observed to be high.

As an example, to use the Trigger ACK flag, the programming steps for triggering an inspection would be:

1. Wait for ready.
2. Set Trigger command flag to 1.
3. Wait for Trigger ACK to go to 1.
4. Set Trigger command flag to 0.

Command Responses

iVu Plus Series Command Channel commands executed using command IDs may have a response value. Depending on the Data Type, the response value will be contained in one or multiple registers. Refer to iVu Command Channel Commands section of this document and the iVu Plus Communication's Users Guide for more information about the iVu Command Channel.

7.3 Sensor Operation

Any Industrial Ethernet protocol can be used to trigger inspections, remote teach and perform command functions. On iVuPlus BCR models, compare strings can also be set.

7.3.1 General Command Execution

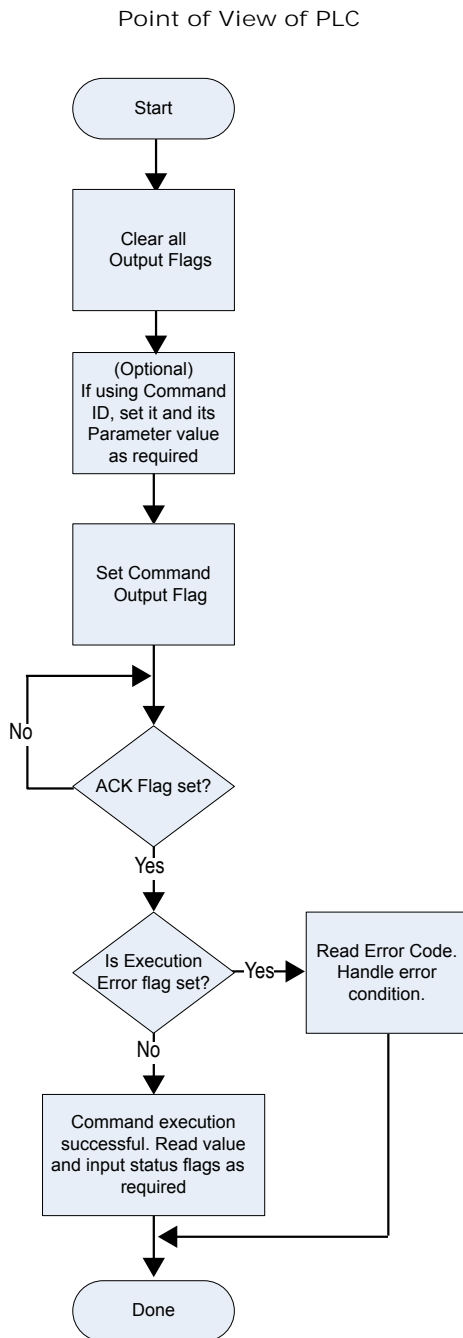

Following rules apply for the usage of input bit commands:

- Only one iVu input bit can be set at a time.
- Corresponding ACK bits are only set high on completion of the command (if the iVu input bit is still high).
- Corresponding ACK bits are cleared when the iVu input bit is cleared.
- When multiple iVu input bits are set simultaneously, the Execution Error input bit is set and an Error Code value is reported in the Error Code register.
- The Execution Error iVu output bit is cleared when all ACK bits get cleared, or a new valid command is received.

7.4 EtherNet/IP

The iVu Plus device is controlled via EtherNet/IP using assembly objects. From the point-of-view of a PLC, there are three input assemblies and two output assemblies.

The Originator of the EtherNet/IP connection is the PLC. The Target of the EtherNet/IP connection is the iVu Plus. The direction of communication can be described as T > O or O > T (sometimes also shown as T2O or O2T).

7.4.1 Inputs to iVu (Outputs from PLC)

PLC Assembly Instance 112 (0x70) - 6 Registers (iVu Inputs/PLC Outputs)

Data transfer direction: Originator (PLC) to Target (iVu Plus). Assembly Instance 112 (0x70) is a small group of registers used for basic control of the iVu Plus.

| WORD # | WORD NAME | DATA TYPE |
|--------|---|----------------|
| 0 | Input Bits Register (see <i>Input and Output Flags Bits</i> on page 89) | 16-bit integer |
| 1-2 | Product Change Number | 32-bit integer |
| 3-5 | <i>reserved</i> | 16-bit integer |

PLC Assembly Instance 113 (0x71) - 240 Registers (iVu Inputs/PLC Outputs)

Data transfer direction: Originator (PLC) to Target (iVu Plus). Assembly Instance 113 (0x71) has more registers than Assembly Instance 112. This allows for more comprehensive control of the iVu Plus, including Command Channel functionality.

| WORD # | WORD NAME | DATA TYPE |
|---------|---|----------------|
| 0 | Inputs Bit Register (see <i>Input and Output Flags Bits</i> on page 89) | 16-bit integer |
| 1-2 | Product Change Number | 32-bit integer |
| 3-49 | <i>reserved</i> | 32-bit integer |
| 50 | Command ID | 16-bit integer |
| 51 | Command Parameter Int16 | 16-bit integer |
| 52-53 | Command Parameter Int32 | 32-bit integer |
| 54-55 | Command Parameter Float | Float |
| 56-57 | String Length | 32-bit integer |
| 58-107 | String Parameter | 100 Byte Array |
| 108 | <i>reserved</i> | 16-bit integer |
| 109-110 | Barcode String/Mask Length | 32-bit integer |
| 111-210 | Barcode String/Mask | 200 Byte Array |
| 211-239 | <i>reserved</i> | 16-bit integer |

7.4.2 Outputs from the iVu (Inputs to the PLC)

PLC Assembly Instance 100 (0x64) - 30 Registers (iVu Outputs/PLC Inputs)

Data transfer direction: Target (iVu Plus) to Originator (PLC). Assembly Instance 100 is a small block of registers providing basic inspection results from the iVu Plus.



NOTE: Assembly Instance 100 does not provide barcode data.

| WORD # | WORD NAME | DATA TYPE |
|--------|---|----------------|
| 0 | Input Bits ACK Register (see <i>Input and Output Flags Bits</i> on page 89) | 16-bit integer |
| 1 | Output Bits Register (see <i>Input and Output Flags Bits</i> on page 89) | 16-bit integer |
| 2-3 | Error Code | 32-bit integer |
| 4-5 | Inspection Number | 32-bit integer |
| 6-7 | Iteration Count | 32-bit integer |
| 8-9 | Pass Count | 32-bit integer |
| 10-11 | Fail Count | 32-bit integer |
| 12-13 | Missed Triggers | 32-bit integer |
| 14-15 | Current Inspection Time | Float |

| WORD # | WORD NAME | DATA TYPE |
|--------|-----------------|----------------|
| 16 | Sensor P/F Coil | 16-bit integer |
| 17-29 | <i>reserved</i> | 16-bit integer |

PLC Assembly Instance 101 (0x65) - 240 Registers (iVu Outputs/PLC Inputs)

Assembly Instance 101 provides space for a single block of barcode data (up to ASCII characters in length) as well as space for Command Channel replies.

| WORD # | WORD NAME | DATA TYPE |
|---------|--|----------------------------------|
| 0 | Input Bits ACK Register (see Input and Output Flags Bits on page 89) | 16-bit integer |
| 1 | Output Bits Register (see Input and Output Flags Bits on page 89) | 16-bit integer |
| 2-3 | Error Code | 32-bit integer |
| 4-5 | Inspection Number | 32-bit integer |
| 6-7 | Iteration Count | 32-bit integer |
| 8-9 | Pass Count | 32-bit integer |
| 10-11 | Fail Count | 32-bit integer |
| 12-13 | Missed Triggers | 32-bit integer |
| 14-15 | Current Inspection Time | Float |
| 16 | Sensor Pass/Fail Coil | 16-bit integer |
| 17-29 | <i>reserved</i> | 16-bit integer |
| 30-52 | Inspection Name | 2-Word Length + 20-unicode chars |
| 53-54 | Frame Number | 32-bit integer |
| 55 | Sensor Type ID | 16-bit integer |
| 56 | Barcode Count | 16-bit integer |
| 57 | Barcode-1 Type | 16-bit integer |
| 58 | Barcode-1 Actual Decoded Data Length | 16-bit integer |
| 59-60 | Barcode-1 Data Array Length | 32-bit integer |
| 61-162 | Barcode-1 Data Array | 100 Byte Array |
| 163-170 | <i>reserved</i> | 16-bit integer |
| 171 | Command Status | 16-bit integer |
| 172 | Command Response Int16 | 16-bit integer |
| 173-174 | Command Response Int32 | 32-bit integer |
| 175-176 | Command Response Float | Float |
| 177-178 | Command Response Length | 32-bit integer |
| 179-228 | Command Response Data | 100 Byte Array |
| 229-239 | <i>reserved</i> | 16-bit integer |

PLC Assembly Instance 102 (0x66) - 240 Registers (iVu Outputs/PLC Inputs)

Data transfer direction: Target (iVu Plus) to Originator (PLC). Assembly Instance 102 provides space for data from up to ten different barcodes read in the same inspection.

| WORD # | WORD NAME | DATA TYPE |
|--------|--|----------------|
| 0 | Input Bits ACK Register (see Input and Output Flags Bits on page 89) | 16-bit integer |
| 1 | Output Bits Register (see Input and Output Flags Bits on page 89) | 16-bit integer |
| 2-3 | Error Code | 32-bit integer |
| 4-5 | Inspection Number | 32-bit integer |
| 6-7 | Iteration Count | 32-bit integer |

| WORD # | WORD NAME | DATA TYPE |
|---------|-------------------------|-------------------------------|
| 8-9 | Pass Count | 32-bit integer |
| 10-11 | Fail Count | 32-bit integer |
| 12-13 | Missed Triggers | 32-bit integer |
| 14-15 | Current Inspection Time | Float |
| 16 | Sensor Pass/Fail Coil | 16-bit integer |
| 17-29 | <i>reserved</i> | 16-bit integer |
| 30 | Barcode Count | 16-bit integer |
| 31 | Barcode-1 Type | 16-bit integer |
| 32 | Barcode-1 Length | 16-bit integer |
| 33-50 | Barcode-1 Data | 32-bit length + 32-byte array |
| 51 | Barcode-2 Type | 16-bit integer |
| 52 | Barcode-2 Length | 16-bit integer |
| 53-70 | Barcode-2 Data | 32-bit length + 32-byte array |
| 71 | Barcode-3 Type | 16-bit integer |
| 72 | Barcode-3 Length | 16-bit integer |
| 73-90 | Barcode-3 Data | 32-bit length + 32-byte array |
| 91 | Barcode-4 Type | 16-bit integer |
| 92 | Barcode-4 Length | 16-bit integer |
| 93-110 | Barcode-4 Data | 32-bit length + 32-byte array |
| 111 | Barcode-5 Type | 16-bit integer |
| 112 | Barcode-5 Length | 16-bit integer |
| 113-130 | Barcode-5 Data | 32-bit length + 32-byte array |
| 131 | Barcode-6 Type | 16-bit integer |
| 132 | Barcode-6 Length | 16-bit integer |
| 133-150 | Barcode-6 Data | 32-bit length + 32-byte array |
| 151 | Barcode-7 Type | 16-bit integer |
| 152 | Barcode-7 Length | 16-bit integer |
| 153-170 | Barcode-7 Data | 32-bit length + 32-byte array |
| 171 | Barcode-8 Type | 16-bit integer |
| 172 | Barcode-8 Length | 16-bit integer |
| 173-190 | Barcode-8 Data | 32-bit length + 32-byte array |
| 191 | Barcode-9 Type | 16-bit integer |
| 192 | Barcode-9 Length | 16-bit integer |
| 193-210 | Barcode-9 Data | 32-bit length + 32-byte array |
| 211 | Barcode-10 Type | 16-bit integer |
| 212 | Barcode-10 Length | 16-bit integer |
| 213-230 | Barcode-10 Data | 32-bit length + 32-byte array |
| 231-239 | <i>reserved</i> | 16-bit integer |

Barcode Type Numeric Codes

| Symbol | Type ID |
|------------|---------|
| No Symbol | 0 |
| DataMatrix | 1 |
| Code 39 | 10 |
| Code 128 | 11 |

| Symbol | Type ID |
|------------------|---------|
| CODABAR | 20 |
| EAN8 | 30 |
| EAN13 | 31 |
| Interleaved 2of5 | 40 |
| UPCE | 50 |
| Postnet | 60 |
| IMB | 70 |
| Pharmacode | 80 |
| QR Code | 90 |

7.4.3 Input and Output Flags Bits

Inputs Bits Register (Command Flag Bits)

Bit Position

| 15 | 14 | 13 | 12 | 11 | 10 | 9 | 8 | 7 | 6 | 5 | 4 | 3 | 2 | 1 | 0 |
|---------|----|----|----|----|----|---|---|---|--------------|----------------|---|---------------|---------|-------------|----------------|
| Command | | | | | | | | | Set BCR Mask | Set BCR String | | Gated Trigger | Trigger | Teach Latch | Product Change |

Input Bits ACK Register (ACK Flag Bits)

Bit Position

| 15 | 14 | 13 | 12 | 11 | 10 | 9 | 8 | 7 | 6 | 5 | 4 | 3 | 2 | 1 | 0 |
|-------------|----|----|----|----|----|---|---|---|------------------|--------------------|---|-------------------|-------------|-----------------|--------------------|
| Command ACK | | | | | | | | | Set BCR Mask ACK | Set BCR String ACK | | Gated Trigger ACK | Trigger ACK | Teach Latch ACK | Product Change ACK |

Output Bits Register (iVu Status Flag Bits)

Bit Position

| 15 | 14 | 13 | 12 | 11 | 10 | 9 | 8 | 7 | 6 | 5 | 4 | 3 | 2 | 1 | 0 |
|-----------------|--------------|-------------|----------------|----|----|---|---|----------|----------|----------|---|-------------|--------------|-----------|-------|
| Execution Error | System Error | Teach Error | Missed Trigger | | | | | Output 3 | Output 2 | Output 1 | | Ready Latch | Read/No Read | Pass/Fail | Ready |

7.4.4 Configuration Assembly Object

The iVuPlus EIP implementation does not support an assembly object configuration instance. However, one is required for creation of implicit Class 1 connections on a ControlLogix family PLC. Therefore, a configuration instance is defined as instance number 0x80 (128 decimal). Its size is zero.

7.4.5 Data Formats

The iVuPlus EIP implementation supports 32-bit Integers in LSW_MSW data format. The least significant word is stored first, then the most significant word. This format is used for Allen-Bradley ControlLogix PLCs.

The string format is compatible with the Allen-Bradley ControlLogix built-in string data type. This format is a 32 bit (DINT) length followed by character bytes (SINT). This results in the following string format as viewed from the iVu Plus:

| Word | 0 | 1 | 2 | | 3 | | 4 | | ... | ... |
|------|------------|------------|--------|--------|--------|--------|--------|--------|-----|-----|
| | Length LSW | Length MSW | byte 1 | byte 0 | byte 3 | byte 2 | byte 5 | byte 4 | | |

7.4.6 Minimum Requested Packet Interval (RPI) Value

iVuPlus devices can operate with input and output Requested Packet Intervals (RPIs) as low as 50 milliseconds. The device may not operate reliably if a lower RPI value is selected.

7.4.7 iVu Plus EDS File Installation in ControlLogix Software

1. Use the EDS Hardware Installation Tool to register the EDS file.

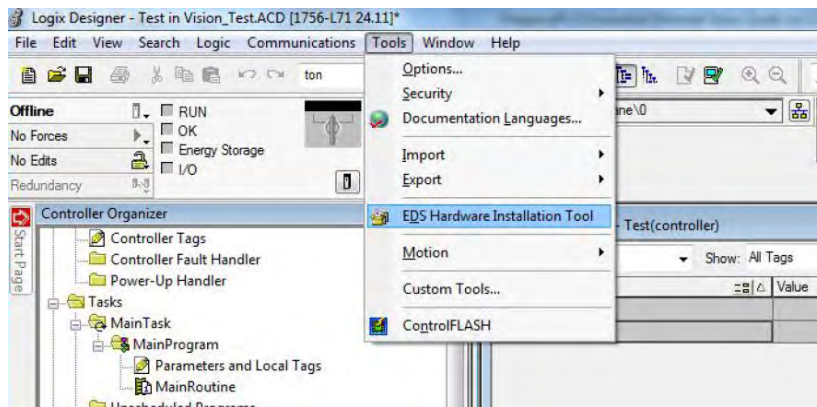

2. Click Next.



3. Select the Register and EDS file(s) option.



4. Browse to locate the EDS file and click Next.

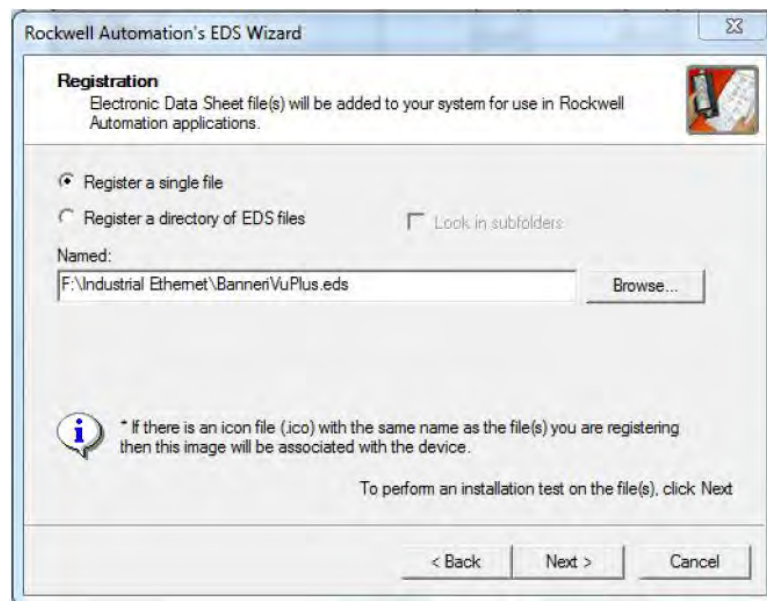

5. Click Next to register the tested file.

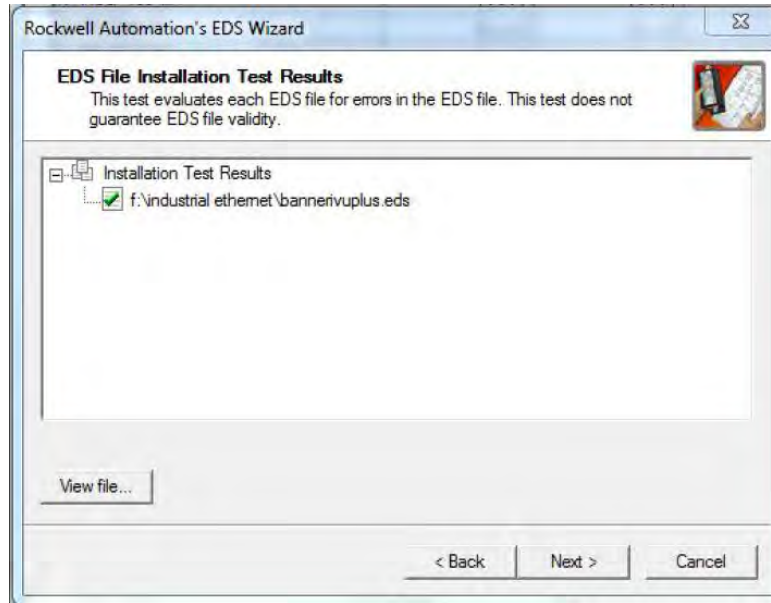

6. Click Next when you see the icon associated with the EDS file.

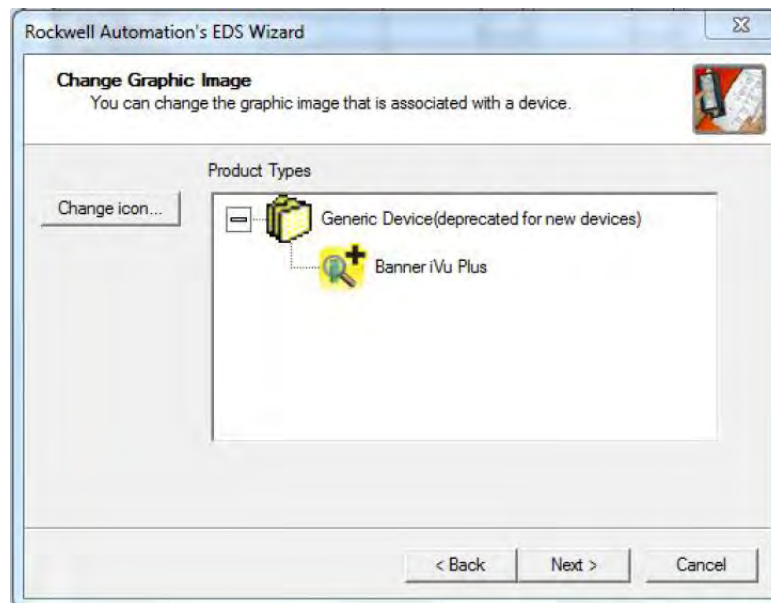

7. Click Next to register the EDS file.

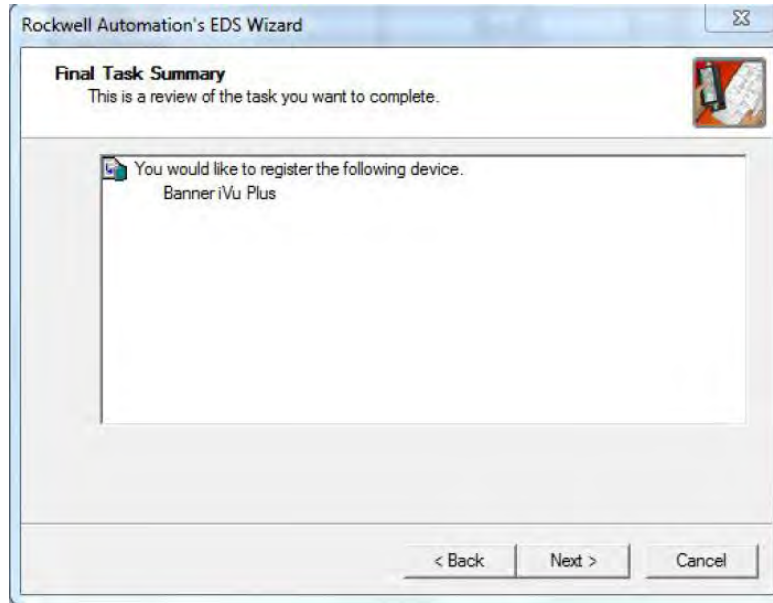

8. Click Finish to close the EDS Wizard window.



9. Right-click on the PLC's Ethernet adapter and select New Module...

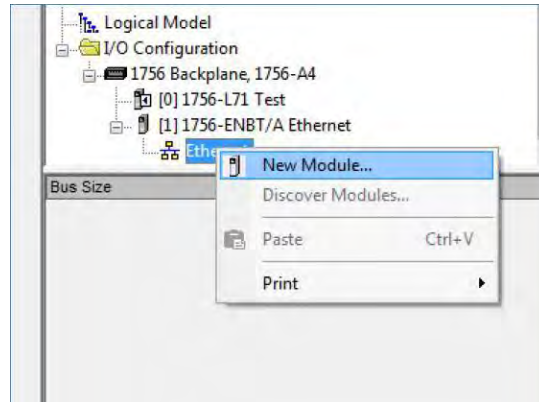

10. Locate iVu Plus from the displayed list and click Create.

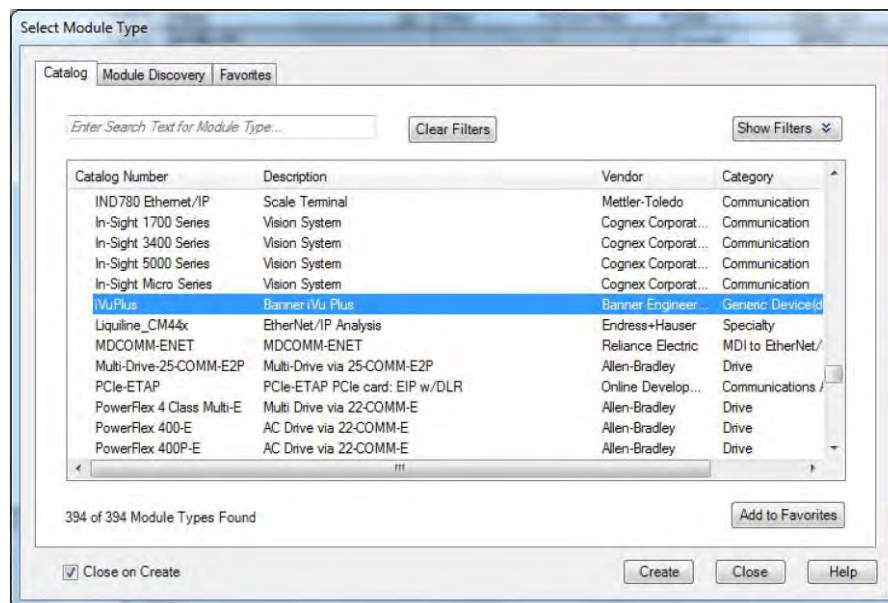

11. Enter a name, optional description, and IP address for the iVu Plus.

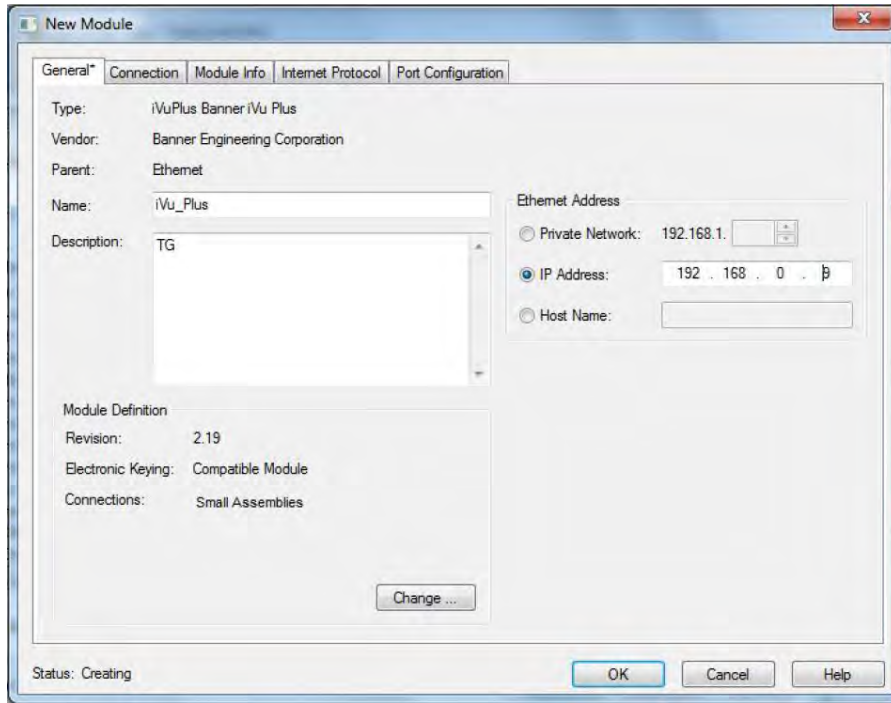

12. Click Change in the Module Definition field.

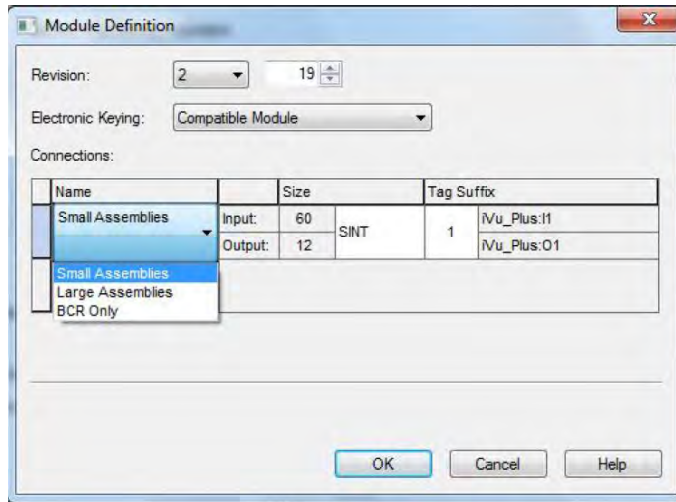

13. Select the desired connection in the Module Definition window. Each of the items in the Name drop-down menu represents a fixed grouping of input and output assembly instances (see below).

- Small Assemblies
- O>T PLC Input/iVu Plus Output Assembly 112 (0x70)
- T>O PLC Output/iVu Plus Input Assembly 100 (0x64)
- Large Assemblies
- O>T PLC Input/iVu Plus Output Assembly 113 (0x71)
- T>O PLC Output/iVu Plus Input Assembly 101 (0x65)
- BCR Only
- O>T PLC Input/iVu Plus Output Assembly 113 (0x71)
- T>O PLC Output/iVu Plus Input Assembly 102 (0x66)

14. Select INT as the data type.

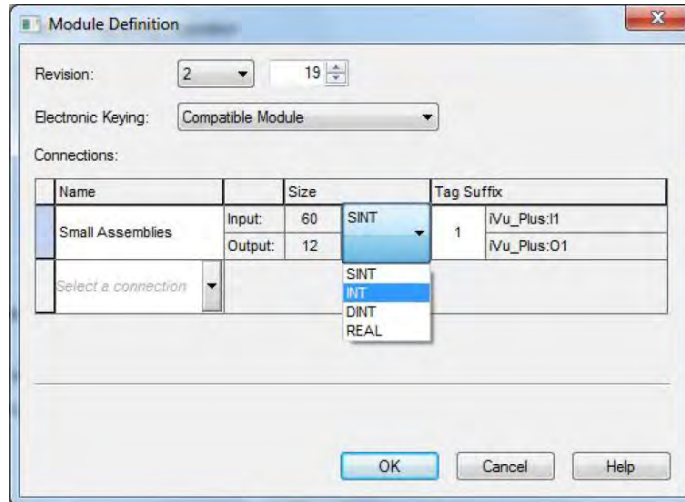

15. Click OK twice and download the program to the PLC.

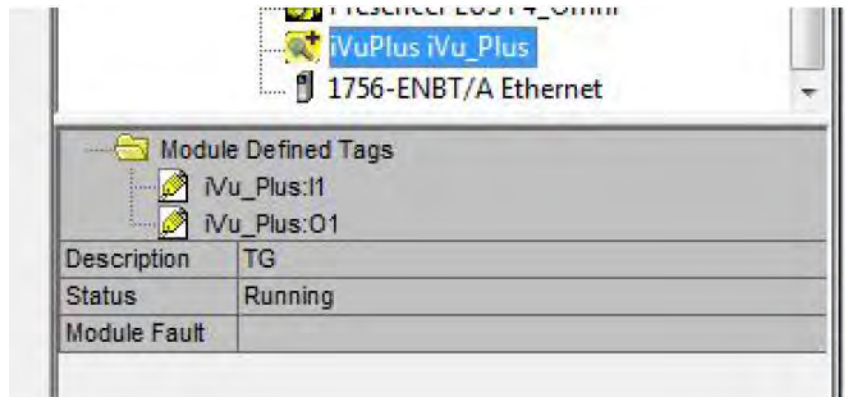

The connection looks like the one above.

7.4.8 RSLogix5000 Configuration

To create an implicit Class 1 configuration to the iVu Plus using EIP when using a ControlLogix family PLC, configure the iVu Plus as a "Generic Ethernet Module" under the ENET_MODULE. The following is a sample setup of Banner sensor:

1. Add a generic Ethernet module to the PLC's Ethernet card.

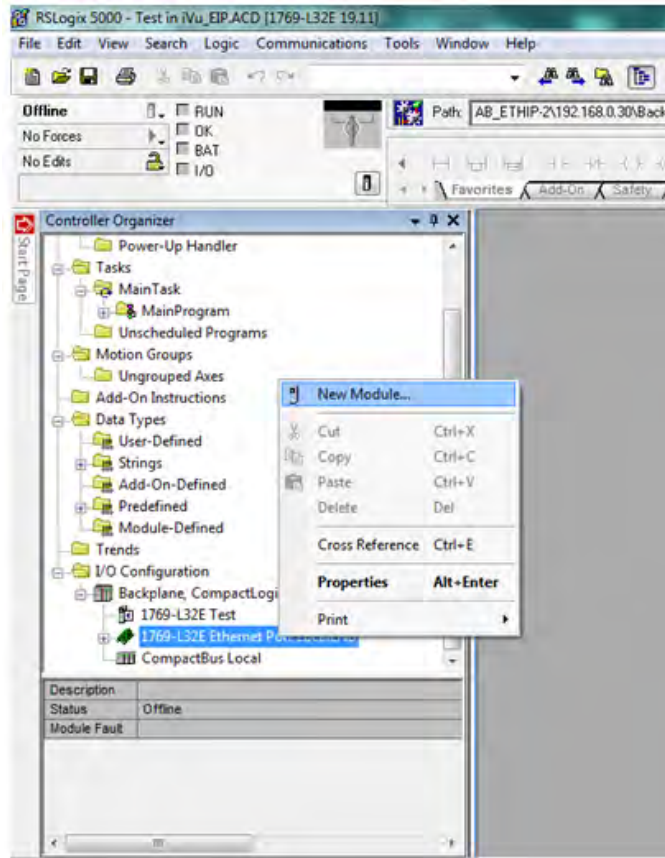

2. Select Module.

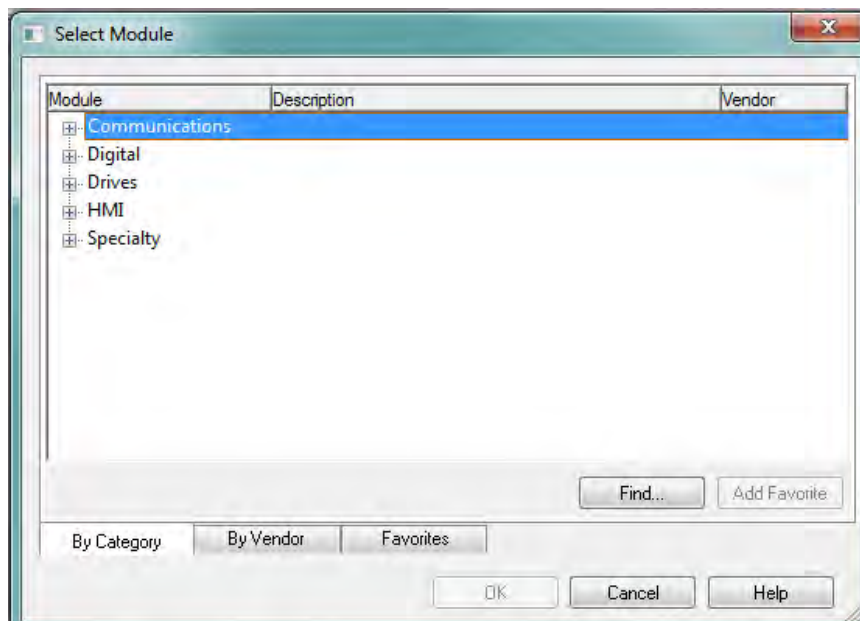

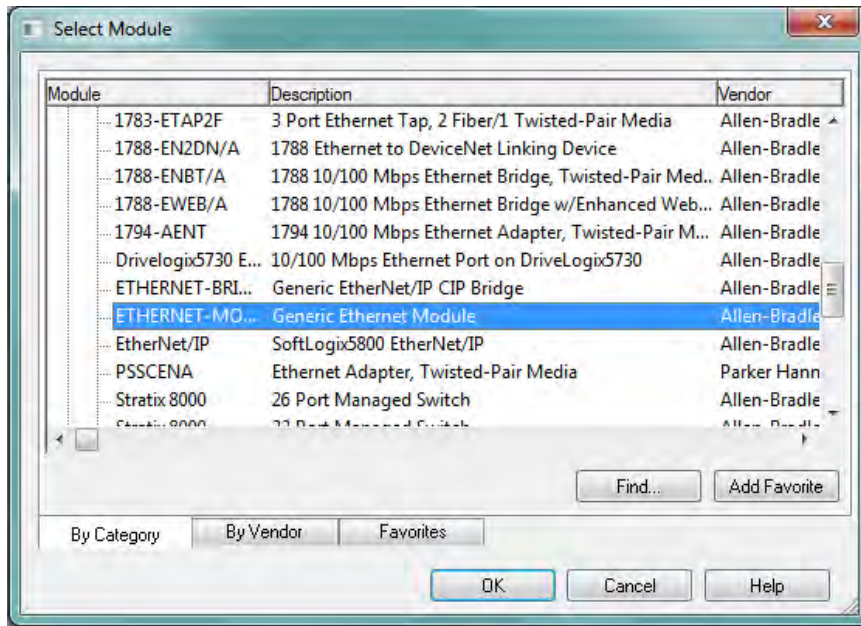

3. Configure Module Properties.



NOTE: The data type in the Comm Format must be changed to an INT.

See [Inputs to iVu \(Outputs from PLC\)](#) on page 86 and [Outputs from the iVu \(Inputs to the PLC\)](#) on page 86 for more information on each specific assembly instance.

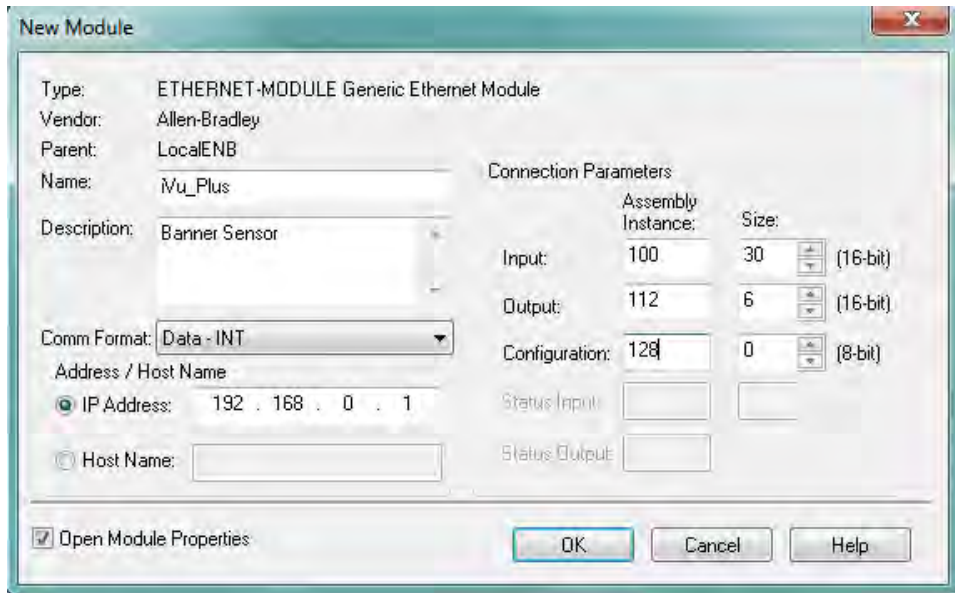

Figure 3. PLC Input Assembly (100), PLC Output Assembly (112)

New Module

Type: ETHERNET-MODULE Generic Ethernet Module
 Vendor: Allen-Bradley
 Parent: LocalENB
 Name: iVu_Plus
 Description: Banner Sensor

Comm Format: Data - INT

Address / Host Name
 IP Address: 192 . 168 . 0 . 1
 Host Name:

| Connection Parameters | | |
|-----------------------|--------------------|--------------|
| | Assembly Instance: | Size: |
| Input: | 101 | 240 (16-bit) |
| Output: | 113 | 240 (16-bit) |
| Configuration: | 128 | 0 (8-bit) |
| Status Input: | | |
| Status Output: | | |

Open Module Properties

OK Cancel Help

Figure 4. PLC Input Assembly (101), PLC Output Assembly (113)

New Module

Type: ETHERNET-MODULE Generic Ethernet Module
 Vendor: Allen-Bradley
 Parent: LocalENB
 Name: iVu_Plus_BCR
 Description: Banner Sensor (BCR)

Comm Format: Data - INT

Address / Host Name
 IP Address: 192 . 168 . 0 . 1
 Host Name:

| Connection Parameters | | |
|-----------------------|--------------------|--------------|
| | Assembly Instance: | Size: |
| Input: | 102 | 240 (16-bit) |
| Output: | 113 | 240 (16-bit) |
| Configuration: | 128 | 0 (8-bit) |
| Status Input: | | |
| Status Output: | | |

Open Module Properties

OK Cancel Help

Figure 5. iVu Plus BCR—PLC Input Assembly (102), PLC Output Assembly (113)

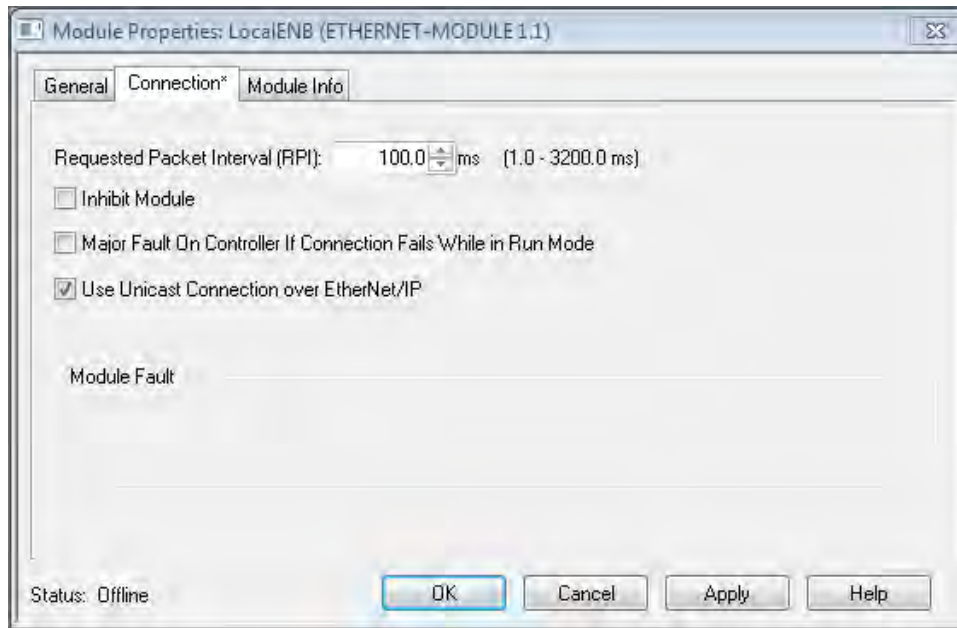
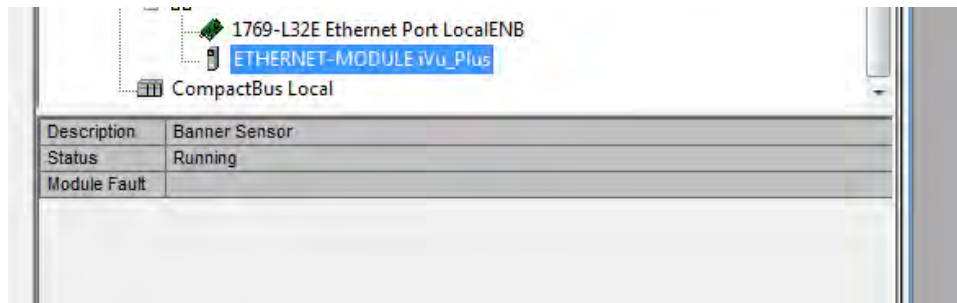

Figure 6. Select or deselect Unicast Connection as desired



NOTE: The minimum allowed RPI is 50 ms.

4. If the module configuration was successful, the following information should be displayed:



If the module configuration was not successful, the RSLogix 5000 software will indicate errors similar to the ones displayed below:

- ERROR: Assembly Instance number and/or size incorrect.

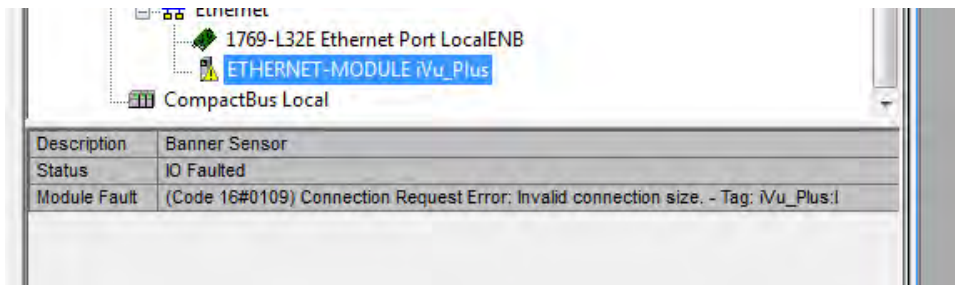

- ERROR: iVu Plus not powered up or EtherNet cable not attached.

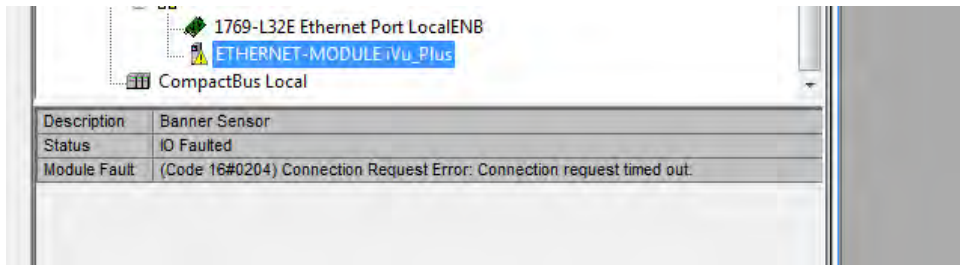

5. Locate the memory map setup from Banner module to PLC memory map.

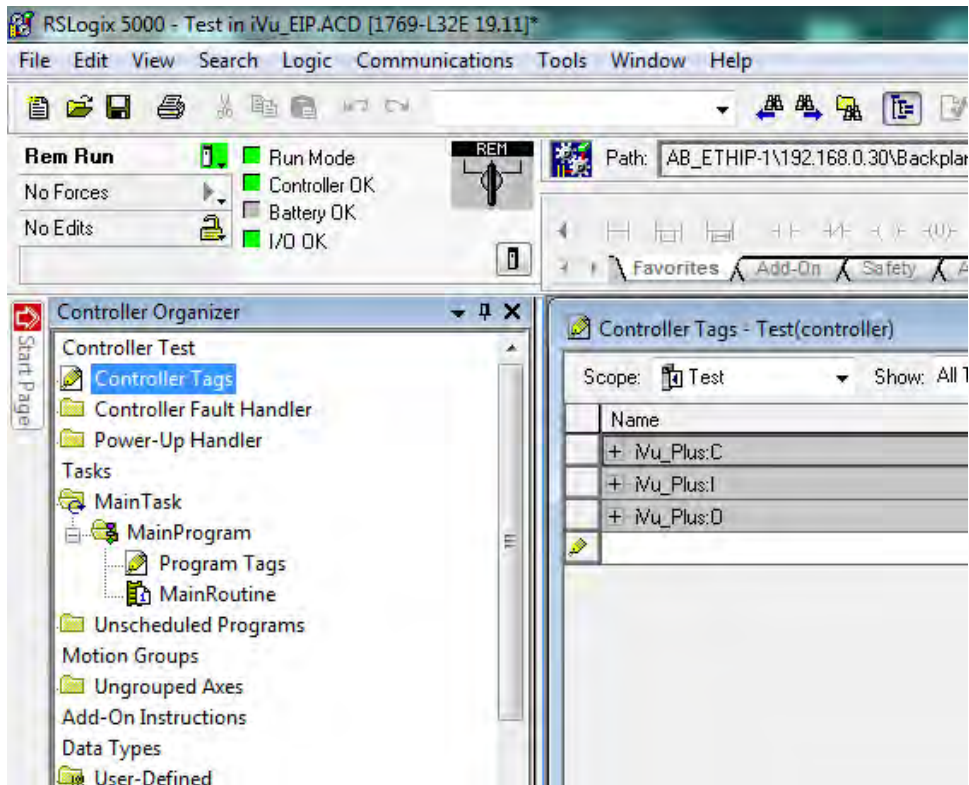

- C = Configuration (not used)
- I = Inputs to PLC (outputs from iVu Plus)
- O = Outputs from PLC (inputs to iVu Plus)

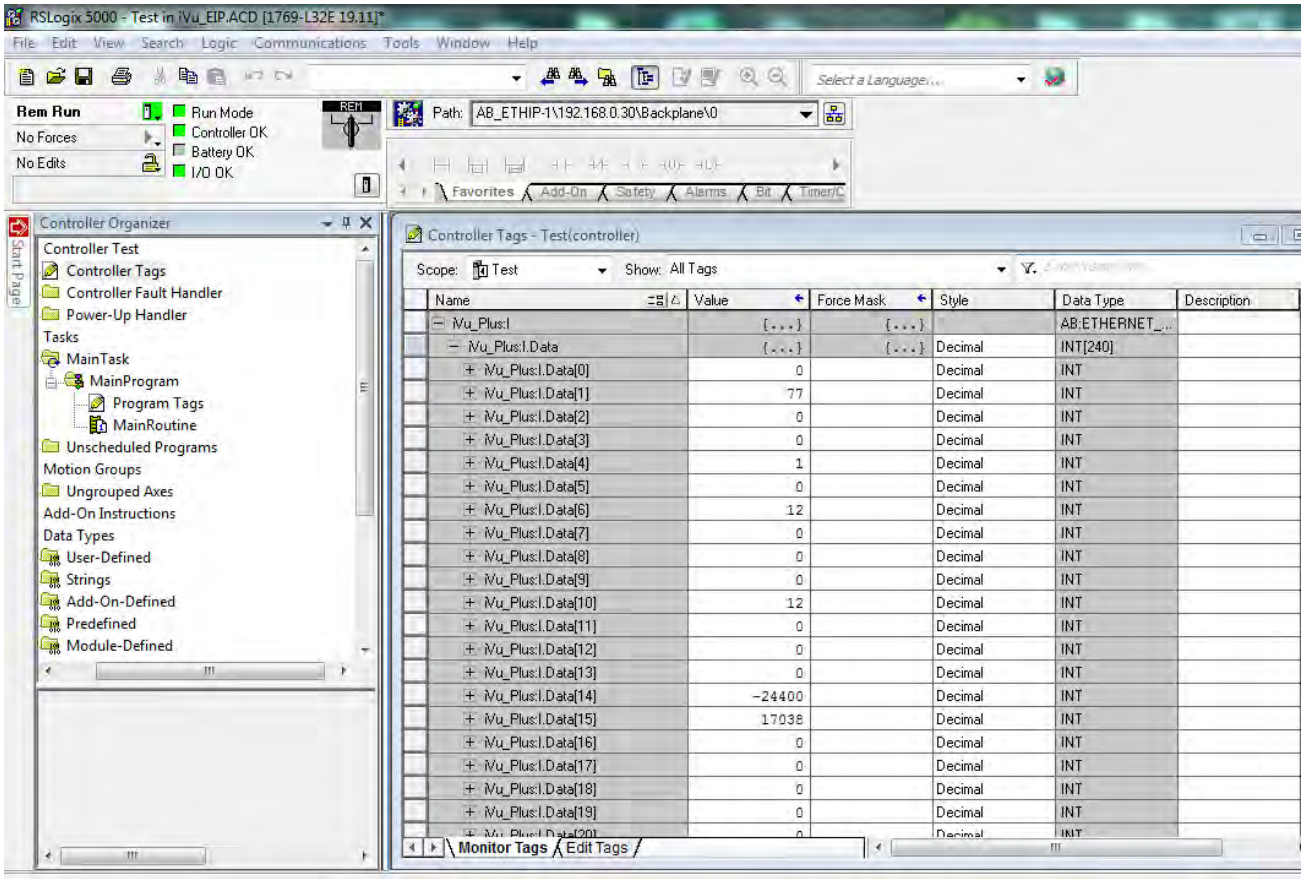

The iVu Plus memory map expanded. I = Inputs to PLC (outputs from iVu Plus).

Sample map demonstrating string values:

| Name | Value | Force Mask | Style | Data Type | Description |
|---------------------|-------|------------|---------|-----------|-------------|
| IVu_Plus:I.Data[55] | 1 | | Decimal | INT | |
| IVu_Plus:I.Data[56] | 1 | | Decimal | INT | |
| IVu_Plus:I.Data[57] | 1 | | Decimal | INT | |
| IVu_Plus:I.Data[58] | 20 | | Decimal | INT | |
| IVu_Plus:I.Data[59] | 20 | | Decimal | INT | |
| IVu_Plus:I.Data[60] | 0 | | Decimal | INT | |
| IVu_Plus:I.Data[61] | 22121 | | Decimal | INT | |
| IVu_Plus:I.Data[62] | 20597 | | Decimal | INT | |
| IVu_Plus:I.Data[63] | 30060 | | Decimal | INT | |
| IVu_Plus:I.Data[64] | 8307 | | Decimal | INT | |
| IVu_Plus:I.Data[65] | 27977 | | Decimal | INT | |
| IVu_Plus:I.Data[66] | 26465 | | Decimal | INT | |
| IVu_Plus:I.Data[67] | 8293 | | Decimal | INT | |
| IVu_Plus:I.Data[68] | 25939 | | Decimal | INT | |
| IVu_Plus:I.Data[69] | 29550 | | Decimal | INT | |
| IVu_Plus:I.Data[70] | 29295 | | Decimal | INT | |

Figure 7. Memory Map: Default



NOTE: ControlLogix string format. "iVu Plus Image Sensor"

| | | | |
|-----------------------|------|---------|-----|
| + iVu_Plus:I.Data[55] | 1 | Decimal | INT |
| + iVu_Plus:I.Data[56] | 1 | Decimal | INT |
| + iVu_Plus:I.Data[57] | 1 | Decimal | INT |
| + iVu_Plus:I.Data[58] | 20 | Decimal | INT |
| + iVu_Plus:I.Data[59] | 20 | Decimal | INT |
| + iVu_Plus:I.Data[60] | 0 | Decimal | INT |
| + iVu_Plus:I.Data[61] | 'Vi' | ASCII | INT |
| + iVu_Plus:I.Data[62] | 'Pu' | ASCII | INT |
| + iVu_Plus:I.Data[63] | 'ul' | ASCII | INT |
| + iVu_Plus:I.Data[64] | 's' | ASCII | INT |
| + iVu_Plus:I.Data[65] | 'mI' | ASCII | INT |
| + iVu_Plus:I.Data[66] | 'ga' | ASCII | INT |
| + iVu_Plus:I.Data[67] | 'e' | ASCII | INT |
| + iVu_Plus:I.Data[68] | 'eS' | ASCII | INT |
| + iVu_Plus:I.Data[69] | 'sn' | ASCII | INT |
| + iVu_Plus:I.Data[70] | 'ro' | ASCII | INT |

All data is initially transferred as "INT" data type. An ASCII string looks like gibberish in this format. Changing the "style" to ASCII instead of "Decimal" reveals the correct string data.

Figure 8. Memory Map: "Style" changed to ASCII

7.5 Modbus/TCP

The Modbus/TCP protocol provides device information using register and coil banks defined by the slave device. This section defines the register and coil banks. By specification, Modbus/TCP uses TCP port 502.

The following registers are used to send values back and forth from the vision sensor to the PLC. iVu Plus read-only output data can be read as Input Registers (30000) using Modbus function code 04 (Read Input Registers). Because some devices like the Modicon family of PLCs cannot access data using the 30000 range of registers, the same values can also be seen as Holding Registers (40000) using Modbus function code 03 (Read Holding Registers).

The Input Bits can be set as Coils using Modbus function code 05 (Force Single Coil). The state of the Input ACK Bits and Status Bits can be read as Inputs (10000) using Modbus function code 02 (Read Input Status).

Modbus Function Codes Supported

- 01: Read Coil Status
- 02: Read Input Status
- 03: Read Holding Registers
- 04: Read Input Registers
- 05: Force Single Coil
- 06: Preset Single Register
- 07: Read Exception Status
- 16: Preset Multiple Registers

Table 8: Input Bits (Coils 00001-00016)

| Register | Bit Position | WORD Name |
|----------|--------------|-----------------|
| 00001 | 0 | Product Change |
| 00002 | 1 | Teach Latch |
| 00003 | 2 | Trigger |
| 00004 | 3 | Gated Trigger |
| 00005 | 4 | <i>reserved</i> |
| 00006 | 5 | Set BCR String |
| 00007 | 6 | Set BCR Mask |
| 00008 | 7 | <i>reserved</i> |
| 00009 | 8 | <i>reserved</i> |

| 05: Force Single Coil | | |
|-----------------------|--------------|-----------------|
| Register | Bit Position | WORD Name |
| 00010 | 9 | <i>reserved</i> |
| 00011 | 10 | <i>reserved</i> |
| 00012 | 11 | <i>reserved</i> |
| 00013 | 12 | <i>reserved</i> |
| 00014 | 13 | <i>reserved</i> |
| 00015 | 14 | <i>reserved</i> |
| 00016 | 15 | Command |

Table 9: Input ACK Bits (Inputs 10001-10016)

| 02: Read Input Status | | |
|-----------------------|--------------|--------------------|
| Register | Bit Position | WORD Name |
| 10001 | 0 | Product Change ACK |
| 10002 | 1 | Teach Latch ACK |
| 10003 | 2 | Trigger ACK |
| 10004 | 3 | Gated Trigger ACK |
| 10005 | 4 | <i>reserved</i> |
| 10006 | 5 | Set BCR String ACK |
| 10007 | 6 | Set BCR Mask ACK |
| 10008 | 7 | <i>reserved</i> |
| 10009 | 8 | <i>reserved</i> |
| 10010 | 9 | <i>reserved</i> |
| 10011 | 10 | <i>reserved</i> |
| 10012 | 11 | <i>reserved</i> |
| 10013 | 12 | <i>reserved</i> |
| 10014 | 13 | <i>reserved</i> |
| 10015 | 14 | <i>reserved</i> |
| 10016 | 15 | Command ACK |

Table 10: Status Bits (Inputs 10017-10032)

| 02: Read Input Status | | |
|-----------------------|--------------|-----------------|
| Register | Bit Position | WORD Name |
| 10017 | 0 | Ready |
| 10018 | 1 | Pass/Fail |
| 10019 | 2 | Read/No Read |
| 10020 | 3 | Ready Latch |
| 10021 | 4 | <i>reserved</i> |
| 10022 | 5 | Output 1 |
| 10023 | 6 | Output 2 |
| 10024 | 7 | Output 3 |
| 10025 | 8 | <i>reserved</i> |
| 10026 | 9 | <i>reserved</i> |

| 02: Read Input Status | | |
|-----------------------|--------------|-----------------|
| Register | Bit Position | WORD Name |
| 10027 | 10 | <i>reserved</i> |
| 10028 | 11 | <i>reserved</i> |
| 10029 | 12 | Missed Trigger |
| 10030 | 13 | Teach Error |
| 10031 | 14 | System Error |
| 10032 | 15 | Execution Error |

7.5.1 iVu Plus Input Values

Holding Registers (40000) are used by the PLC or HMI to write values to the iVu Plus sensor. To write, use function codes 6 (Preset Single Register) or 16 (Preset Multiple Registers).

Table 11: iVu Plus Input Values (Modbus/TCP Holding Registers)

| 06: Preset Single Register or 16: Preset Multiple Registers | | |
|---|---|-----------------------------|
| REG # | WORD NAME | DATA TYPE |
| 1 | Input Bits (See Flags on page 107 and Coils 00001-16) | 16-bit Integer |
| 2-3 | Product Change Number | 32-bit Integer |
| 4-50 | <i>reserved</i> | 16-bit Integer |
| 51 | Command ID | 16-bit Integer |
| 52 | Command Parameter Int16 | 16-bit Integer |
| 53-54 | Command Parameter Int32 | 32-bit Integer |
| 55-56 | Command Parameter | Float |
| 57-58 | Command Parameter ASCII String Length | 32-bit Integer |
| 59-108 | Command Parameter ASCII String | 100 byte Unicode char array |
| 109 | <i>reserved</i> | 16-bit Integer |
| 110-111 | BCR ASCII String/Mask Length | 32-bit Integer |
| 112-211 | BCR ASCII String/Mask | 200 byte Unicode char array |
| 212-240 | <i>reserved</i> | 16-bit Integer |

7.5.2 iVu Plus Output Values

The iVu Plus sends output data to the PLC or HMI via a bank of Input Registers (30000). Some devices, like the Modicon family of PLCs, cannot access data using the 30000 range of register addresses. For these devices, the iVu Plus output data is also made available as Holding Registers (40000). To access this data, use either function code 04 (Read Input Registers) or function code 03 (Read Holding Registers).

Table 12: iVu Plus Output Values (Modbus/TCP Input or Holding Registers)

| 04: Read Input Registers or 03: Read Holding Registers | | | |
|--|---------------|---|----------------|
| Input REG # | Holding REG # | WORD NAME | DATA TYPE |
| 1 | 1001 | Input ACK Bits (see Flags on page 107) see also Inputs 10001-16 | 16-bit Integer |
| 2 | 1002 | Status Bits (see Flags on page 107) see also Inputs 10017-32 | 16-bit Integer |
| 3-4 | 1003-4 | Error Code | 32-bit Integer |

| 04: Read Input Registers or 03: Read Holding Registers | | | |
|--|---------------|--------------------------------------|---------------------------------------|
| Input REG # | Holding REG # | WORD NAME | DATA TYPE |
| 5-6 | 1005-6 | Inspection Number | 32-bit Integer |
| 7-8 | 1007-8 | Iteration Count | 32-bit Integer |
| 9-10 | 1009-10 | Pass Count | 32-bit Integer |
| 11-12 | 1011-12 | Fail Count | 32-bit Integer |
| 13-14 | 1013-14 | Missed Triggers | 32-bit Integer |
| 15-16 | 1015-16 | Current Inspection Time | Float |
| 17 | 1017 | Sensor Pass/Fail Bits | 16-bit Integer |
| 18-30 | 1018-30 | <i>reserved</i> | 16-bit Integer |
| 31-53 | 1031-53 | Inspection Name | 2-word Length + 20 Unicode chars |
| 54-55 | 1054-55 | Frame Number | 32-bit Integer |
| 56 | 1056 | Sensor Type ID | 16-bit Integer |
| 57 | 1057 | Barcode Count | 16-bit Integer |
| 58 | 1058 | Barcode-1 Type | 16-bit Integer |
| 59 | 1059 | Barcode-1 Actual Decoded Data Length | 16-bit Integer |
| 60-61 | 1060-61 | Barcode-1 Data Array Length | 32-bit Integer |
| 62-163 | 1062-163 | Barcode-1 Data Array | 100 Byte Array |
| 164-171 | 1164-171 | <i>reserved</i> | 16-bit Integer |
| 172 | 1172 | Command Status | 16-bit Integer |
| 173 | 1173 | Command Response Int16 | 16-bit Integer |
| 174-75 | 1174-75 | Command Response Int32 | 32-bit Integer |
| 176-77 | 1176-77 | Command Response | Float |
| 178-79 | 1178-79 | Command Response ASCII String Length | 16-bit Integer |
| 180-229 | 1180-229 | Command Response ASCII String Data | 100 byte Unicode char array |
| 230-40 | 1230-40 | <i>reserved</i> | 16-bit Integer |
| 241 | 1241 | Barcode Count | 16-bit Integer |
| 242 | 1242 | Barcode-1 Type | 16-bit Integer |
| 243 | 1243 | Barcode-1 Length | 16-bit Integer |
| 244-61 | 1244-61 | Barcode-1 Data | 32-bit length + 32 Unicode char array |
| 262 | 1262 | Barcode-2 Type | 16-bit Integer |
| 263 | 1263 | Barcode-2 Length | 16-bit Integer |
| 264-81 | 1264-81 | Barcode-2 Data | 32-bit length + 32 Unicode char array |
| 282 | 1282 | Barcode-3 Type | 16-bit Integer |
| 283 | 1283 | Barcode-3 Length | 16-bit Integer |
| 284-301 | 1284-301 | Barcode-3 Data | 32-bit length + 32 Unicode char array |
| 302 | 1302 | Barcode-4 Type | 16-bit Integer |
| 303 | 1303 | Barcode-4 Length | 16-bit Integer |
| 304-21 | 1304-21 | Barcode-4 Data | 32-bit length + 32 Unicode char array |
| 322 | 1322 | Barcode-5 Type | 16-bit Integer |

| 04: Read Input Registers or 03: Read Holding Registers | | | |
|--|---------------|-------------------|---------------------------------------|
| Input REG # | Holding REG # | WORD NAME | DATA TYPE |
| 323 | 1323 | Barcode-5 Length | 16-bit Integer |
| 324-41 | 1324-41 | Barcode-5 Data | 32-bit length + 32 Unicode char array |
| 342 | 1342 | Barcode-6 Type | 16-bit Integer |
| 343 | 1343 | Barcode-6 Length | 16-bit Integer |
| 344-61 | 1344-61 | Barcode-6 Data | 32-bit length + 32 Unicode char array |
| 362 | 1362 | Barcode-7 Type | 16-bit Integer |
| 363 | 1363 | Barcode-7 Length | 16-bit Integer |
| 364-81 | 1364-81 | Barcode-7 Data | 32-bit length + 32 Unicode char array |
| 382 | 1382 | Barcode-8 Type | 16-bit Integer |
| 383 | 1383 | Barcode-8 Length | 16-bit Integer |
| 384-401 | 1384-401 | Barcode-8 Data | 32-bit length + 32 Unicode char array |
| 402 | 1402 | Barcode-9 Type | 16-bit Integer |
| 403 | 1403 | Barcode-9 Length | 16-bit Integer |
| 404-21 | 1404-21 | Barcode-9 Data | 32-bit length + 32 Unicode char array |
| 422 | 1422 | Barcode-10 Type | 16-bit Integer |
| 423 | 1423 | Barcode-10 Length | 16-bit Integer |
| 424-41 | 1424-41 | Barcode-10 Data | 32-bit length + 32 Unicode char array |

7.5.3 Flags

Writeable Input Bits are inputs to the iVu Plus (outputs from the PLC or HMI). They are used for basic control of the sensor. They are accessible using function code 6 (Preset Single Register). The same control is also possible using Coils 00001-16, function code 05 (Force Single Coil).

Table 13: Input Bits: PLC Holding Register 1, also Coils 00001-16

| Coil 16 | Coil 15 | Coil 14 | Coil 13 | Coil 12 | Coil 11 | Coil 10 | Coil 9 | Coil 8 | Coil 7 | Coil 6 | Coil 5 | Coil 4 | Coil 3 | Coil 2 | Coil 1 |
|---------|----------|----------|----------|----------|----------|----------|----------|----------|--------------|----------------|----------|---------------|---------|-------------|----------------|
| Bit 15 | Bit 14 | Bit 13 | Bit 12 | Bit 11 | Bit 10 | Bit 9 | Bit 8 | Bit 7 | Bit 6 | Bit 5 | Bit 4 | Bit 3 | Bit 2 | Bit 1 | Bit 0 |
| Command | reserved | reserved | reserved | reserved | reserved | reserved | reserved | reserved | Set BCR Mask | Set BCR String | reserved | Gated Trigger | Trigger | Teach Latch | Product Change |

Read-only I Input ACK Bits are outputs from the iVu Plus sensor (inputs to the PLC or HMI). They are used to acknowledge each of the input bits sent from the PLC. For example, if the PLC changes the Trigger bit (from Input Bits, above) from a 0 to a 1, the iVu will change the Trigger ACK bit from a 0 to a 1 in response. This information is available as Input Registers or Holding Registers. Use either function code 04 (Read Input Registers) or function code 03 (Read Holding Registers). The same data can be seen as Inputs (10000) using Modbus function code 02 (Read Input Status).

Table 14: Input ACK Bits: PLC Input Register 1 or Holding Register 1001, also Inputs 10001-16

| Input 16 | Input 15 | Input 14 | Input 13 | Input 12 | Input 11 | Input 10 | Input 9 | Input 8 | Input 7 | Input 6 | Input 5 | Input 4 | Input 3 | Input 2 | Input 1 |
|-------------|----------|----------|----------|----------|----------|----------|----------|----------|------------------|--------------------|----------|-------------------|-------------|-----------------|--------------------|
| Bit 15 | Bit 14 | Bit 13 | Bit 12 | Bit 11 | Bit 10 | Bit 9 | Bit 8 | Bit 7 | Bit 6 | Bit 5 | Bit 4 | Bit 3 | Bit 2 | Bit 1 | Bit 0 |
| Command ACK | reserved | reserved | reserved | reserved | reserved | reserved | reserved | reserved | Set BCR Mask ACK | Set BCR String ACK | reserved | Gated Trigger ACK | Trigger ACK | Teach Latch ACK | Product Change ACK |

Read-only Status Bits are outputs from the iVu Plus sensor (inputs to the PLC or HMI). They are used to report the basic status of the sensor and the last inspection run. This information is available as Input Registers or Holding Registers. Use either function code 04 (Read Input Registers) or function code 03 (Read Holding Registers). The same data can be seen as Inputs (10000) using Modbus function code 02 (Read Input Status).

Table 15: Status Bits: PLC Input Register 2 or Holding Register 1002, also Inputs 10017-32

| | | | | | | | | | | | | | | | |
|-----------------|--------------|-------------|----------------|----------|----------|----------|----------|----------|----------|----------|----------|-------------|--------------|-----------|----------|
| Input 32 | Input 31 | Input 30 | Input 29 | Input 28 | Input 27 | Input 26 | Input 25 | Input 24 | Input 23 | Input 22 | Input 21 | Input 20 | Input 19 | Input 18 | Input 17 |
| Bit 15 | Bit 14 | Bit 13 | Bit 12 | Bit 11 | Bit 10 | Bit 9 | Bit 8 | Bit 7 | Bit 6 | Bit 5 | Bit 4 | Bit 3 | Bit 2 | Bit 1 | Bit 0 |
| Execution Error | System Error | Teach Error | Missed Trigger | reserved | reserved | reserved | reserved | Output 3 | Output 2 | Output 1 | reserved | Ready Latch | Read/No Read | Pass/Fail | Ready |

7.6 PLC5 and SLC 5 (PCCC)

Allen-Bradley’s PLC5 and SLC 500 family of devices use PCCC communications protocol. iVu Plus supports these PLCs using input and output register arrays. The Output Flags, ACK Flags and Input Flags bit definitions are the same as defined in the EIP Assembly Objects section. The terms “Input” and “Output” are from the point of view of the PLC.

7.6.1 Configuration

The images below represent a typical configuration.

1. Read. In the below example, message command reading from N7 table on iVu Plus and sending the data to the N7 table on the PLC.

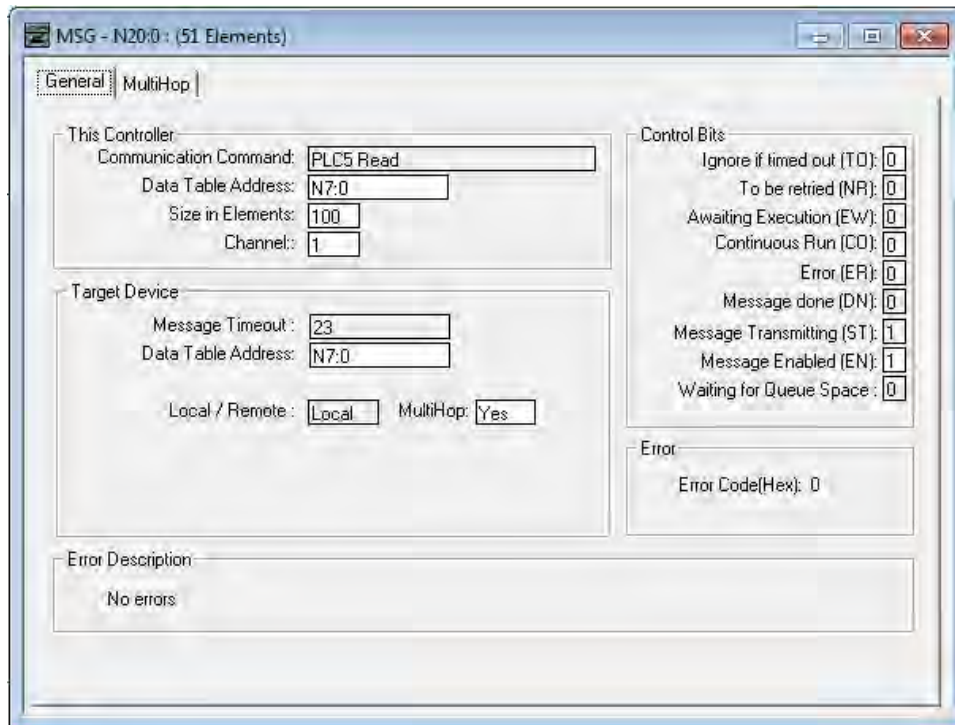

2. Read. IP Address of the iVu Plus is entered here.

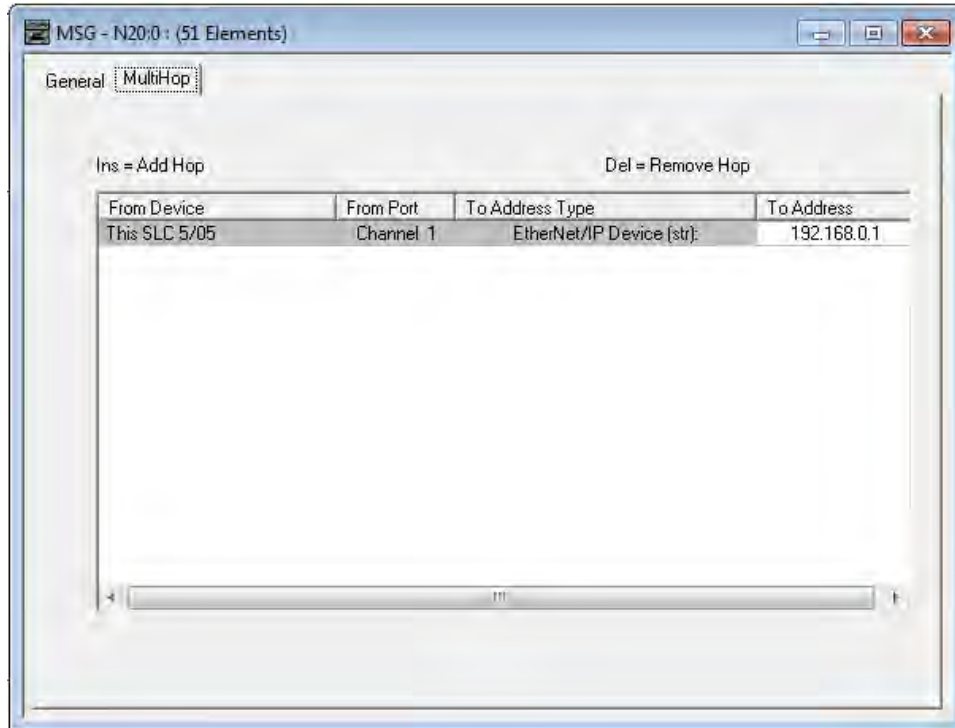

3. Write. In the below example, message command writing to N14 table on the iVu Plus from the N14 table of the PLC.

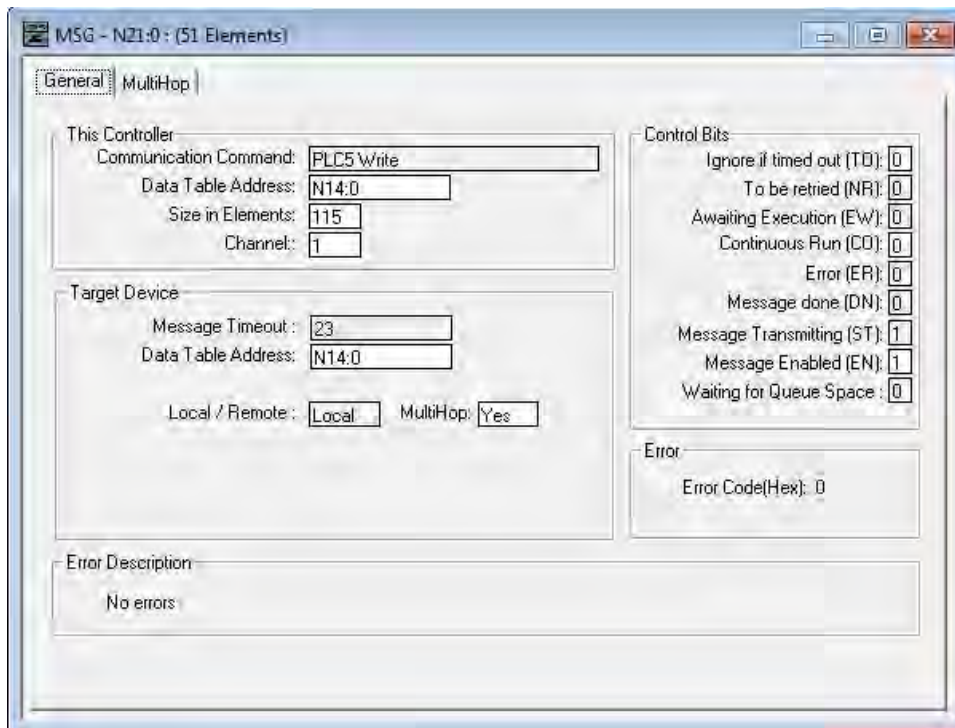

4. Write. IP address of the iVu Plus is entered here.

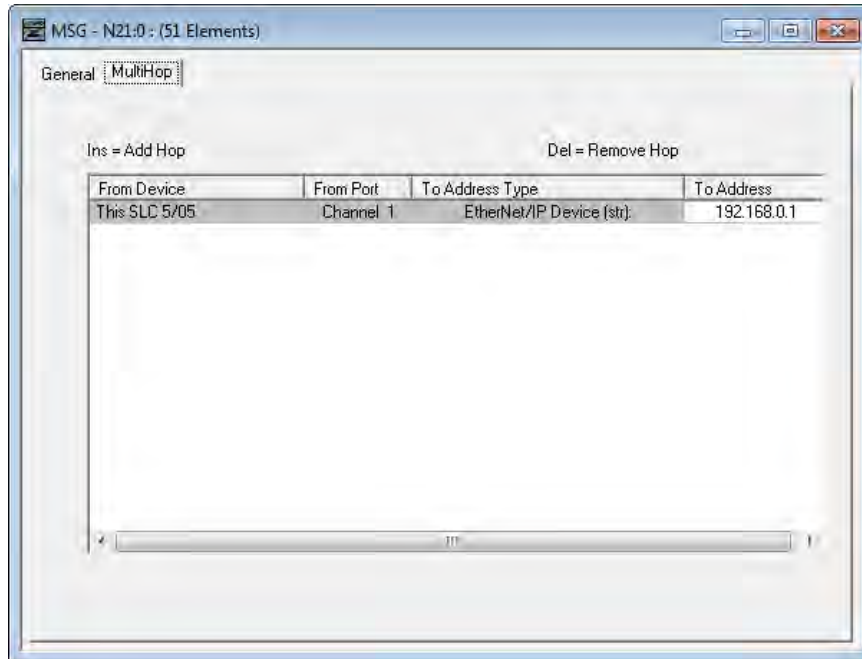

7.6.2 Inputs to iVu (Outputs from PLC)

The registers below are used by the PLC to push values to the iVu Plus sensor. MSG (message) commands are used to write (N14) to the sensor.

See [Barcode Type Numeric Codes](#) on page 88 for additional information.

Table 16: PCCC PLC Output Registers (iVu Plus Inputs, N14 Table)

| WORD # | WORD NAME | DATA TYPE |
|---------|--|----------------|
| 0 | Input Bits Register (see Input and Output Flags on page 112) | 16-bit integer |
| 1-2 | Product Change Number | 32-bit integer |
| 3-49 | <i>reserved</i> | 32-bit integer |
| 50 | Command ID | 16-bit integer |
| 51 | Command Parameter Int16 | 16-bit integer |
| 52-53 | Command Parameter Int 32 | 32-bit integer |
| 54-55 | Command Parameter | Float |
| 56-57 | Command Parameter String Length | 32-bit integer |
| 58-107 | Command Parameter String | 100 Byte Array |
| 108 | <i>reserved</i> | 16-bit integer |
| 109-110 | BCR String/Mask Length | 32-bit integer |
| 111-120 | BCR String/Mask | 200 Byte Array |
| 211-239 | <i>reserved</i> | 16-bit integer |

7.6.3 Outputs from iVu (Inputs to PLC)

The registers below are used to send output values from the iVu Plus to the PLC. MSG (message) commands are used to read (N7) from the sensor.

Table 17: PCCC PLC Input Registers (iVu Plus Outputs, N7 Table)

| WORD # | WORD NAME | DATA TYPE |
|---------|--|----------------------------------|
| 0 | Input Bits ACK Register (see Input and Output Flags on page 112) | 16-bit integer |
| 1 | Output Bits Register (see Input and Output Flags on page 112) | 16-bit integer |
| 2-3 | Error Code | 32-bit integer |
| 4-5 | Inspection Number | 32-bit integer |
| 6-7 | Iteration Count | 32-bit integer |
| 8-9 | Pass Count | 32-bit integer |
| 10-11 | Fail Count | 32-bit integer |
| 12-13 | Missed Triggers | 32-bit integer |
| 14-15 | Current Inspection Time | Float |
| 16 | Sensor Pass/Fail Coil | 16-bit integer |
| 17-29 | <i>reserved</i> | 16-bit integer |
| 30-52 | Inspection Name | 2-Word Length + 20-unicode chars |
| 53-54 | Frame Number | 32-bit integer |
| 55 | Sensor Type ID | 16-bit integer |
| 56 | Barcode Count | 16-bit integer |
| 57 | Barcode-1 Type | 16-bit integer |
| 58 | Barcode-1 Actual Decoded Data Length | 16-bit integer |
| 59-60 | Barcode-1 Data Array Length | 32-bit integer |
| 61-162 | Barcode-1 Data Array | 100 Byte Array |
| 163-170 | <i>reserved</i> | 16-bit integer |
| 171 | Command Status | 16-bit integer |
| 172 | Command Response Int16 | 16-bit integer |
| 173-174 | Command Response Int32 | 32-bit integer |
| 175-176 | Command Response | Float |
| 177-178 | Command Response Length | 32-bit integer |
| 179-228 | Command Response Data | 100 Byte Array |
| 229-239 | <i>reserved</i> | 16-bit integer |
| 240 | Barcode Count | 16-bit integer |
| 241 | Barcode-1 Type | 16-bit integer |
| 242 | Barcode-1 Length | 16-bit integer |
| 243-260 | Barcode-1 Data | 32-bit length + 32-byte array |
| 261 | Barcode-2 Type | 16-bit integer |
| 262 | Barcode-2 Length | 16-bit integer |
| 263-280 | Barcode-2 Data | 32-bit length + 32-byte array |
| 281 | Barcode-3 Type | 16-bit integer |
| 282 | Barcode-3 Length | 16-bit integer |
| 283-300 | Barcode-3 Data | 32-bit length + 32-byte array |
| 301 | Barcode-4 Type | 16-bit integer |
| 302 | Barcode-4 Length | 16-bit integer |
| 303-320 | Barcode-4 Data | 32-bit length + 32-byte array |

| WORD # | WORD NAME | DATA TYPE |
|---------|-------------------|-------------------------------|
| 321 | Barcode-5 Type | 16-bit integer |
| 322 | Barcode-5 Length | 16-bit integer |
| 323-340 | Barcode-5 Data | 32-bit length + 32-byte array |
| 341 | Barcode-6 Type | 16-bit integer |
| 342 | Barcode-6 Length | 16-bit integer |
| 343-360 | Barcode-6 Data | 32-bit length + 32-byte array |
| 361 | Barcode-7 Type | 16-bit integer |
| 362 | Barcode-7 Length | 16-bit integer |
| 363-380 | Barcode-7 Data | 32-bit length + 32-byte array |
| 381 | Barcode-8 Type | 16-bit integer |
| 382 | Barcode-8 Length | 16-bit integer |
| 383-400 | Barcode-8 Data | 32-bit length + 32-byte array |
| 401 | Barcode-9 Type | 16-bit integer |
| 402 | Barcode-9 Length | 16-bit integer |
| 403-420 | Barcode-9 Data | 32-bit length + 32-byte array |
| 421 | Barcode-10 Type | 16-bit integer |
| 422 | Barcode-10 Length | 16-bit integer |
| 423-440 | Barcode-10 Data | 32-bit length + 32-byte array |

7.6.4 Input and Output Flags

The Input Bits are used to command execution of basic functions. The Output Bits are used to push single bit outputs from the iVu Sensor to the PLC. The 32 bits of iVu output can also be accessed using the bits of the first two Output Registers (Input Bits ACK Register(word 0) and Output Bits Register (word1)).

Input Bits Register

Bit Position

| 15 | 14 | 13 | 12 | 11 | 10 | 9 | 8 | 7 | 6 | 5 | 4 | 3 | 2 | 1 | 0 |
|---------|----|----|----|----|----|---|---|---|--------------|----------------|---|---------------|---------|-------------|----------------|
| Command | | | | | | | | | Set BCR Mask | Set BCR String | | Gated Trigger | Trigger | Teach Latch | Product Change |

Input Bits ACK Register

Bit Position

| 15 | 14 | 13 | 12 | 11 | 10 | 9 | 8 | 7 | 6 | 5 | 4 | 3 | 2 | 1 | 0 |
|-------------|----|----|----|----|----|---|---|---|------------------|--------------------|---|-------------------|-------------|-----------------|--------------------|
| Command ACK | | | | | | | | | Set BCR Mask ACK | Set BCR String ACK | | Gated Trigger ACK | Trigger ACK | Teach Latch ACK | Product Change ACK |

Output Bits Register

Bit Position

| 15 | 14 | 13 | 12 | 11 | 10 | 9 | 8 | 7 | 6 | 5 | 4 | 3 | 2 | 1 | 0 |
|-----------------|--------------|-------------|----------------|----|----|---|---|----------|----------|----------|---|-------------|--------------|-----------|-------|
| Execution Error | System Error | Teach Error | Missed Trigger | | | | | Output 3 | Output 2 | Output 1 | | Ready Latch | Read/No Read | Pass/Fail | Ready |

7.7 PROFINET

PROFINET® is a data communication protocol for industrial automation and processes. PROFINET IO defines how controllers (masters) and peripheral devices (slaves) exchange data in real time.

The image sensor, iVu Plus BCR Gen2, supports PROFINET IO. The data communication protocol is TCP/IP; the data transmission medium is copper wire; the PROFINET conformance class is CC-A.



NOTE: In this document, outputs from the iVu Plus BCR Gen2 device are referred to as "inputs" to the controller (PLC). Outputs from the controller (PLC) are referred to as "inputs" to the iVu Plus BCR Gen2 device.

7.7.1 General Station Description (GSD) File

The General Station Description (GSD) file contains module information, such as:

- Configuration data;
- Data information (pass count, inspection status, etc.); and
- Diagnostics.



NOTE: A single iVu Plus GSD file describes both the iVu Plus TG and the iVu Plus BCR.

7.7.2 iVu PROFINET IO Data Model

The PROFINET IO data model is based on the typical, expandable field device that has a backplane with slots. Modules and submodules have different functionalities. Modules are plugged into slots; submodules are plugged into subslots. In the PROFINET IO data model, Slot 0 Subslot 1 is reserved for the Device Access Point (DAP) or network interface.

Both modules and submodules are used to control the type and volume of data that is sent to the controller (PLC).

- A submodule is typically designated as input type, output type, or combined input/output type.
- An input submodule is used to send data to the controller (PLC).
- An output submodule is used to receive data from the controller (PLC).
- The combined input/output submodule simultaneously receives and sends data in both directions.

Configuring the iVu for a PROFINET IO Connection

The iVu Plus BCR device and the controller (PLC) must be configured for PROFINET® .

¹ PROFINET® is a registered trademark of PROFIBUS Nutzerorganisation e.V.

² CC-A ensures that the device has the minimum properties in regard to functionality and interoperability.

1. Click on the Wrench button on the iVu Plus Home screen.

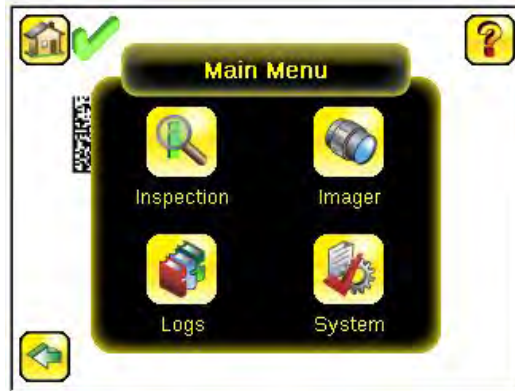

The Main Menu window displays.

2. Click on System and scroll down to Communications.

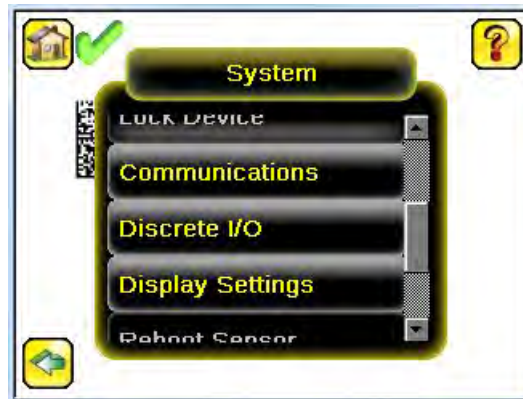

3. Click on Communications.

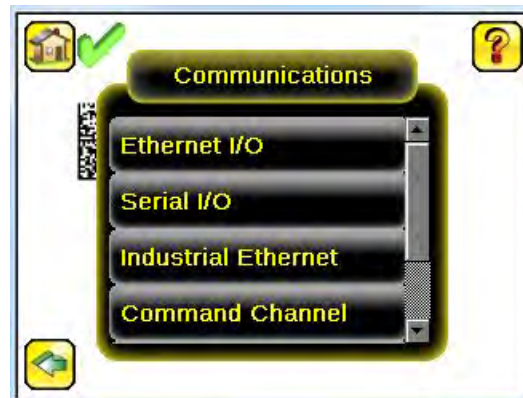

- Click on Industrial Ethernet.

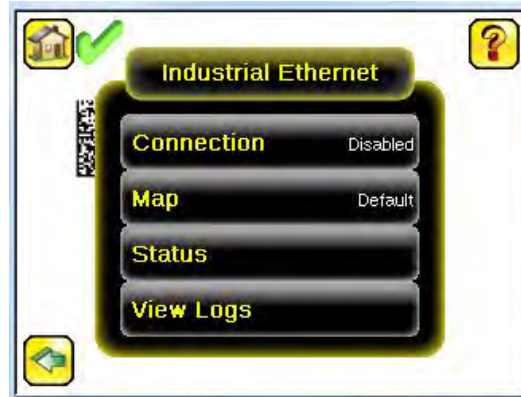

Click on Connection.



NOTE: The default Industrial Ethernet Connection setting is set to Disabled.

- Click on PROFINET in the drop-down menu.

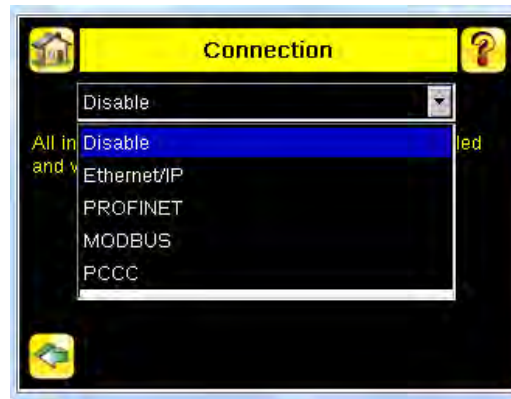

- Click (only one time) on the Arrow button on the bottom left to return to the Industrial Ethernet window.

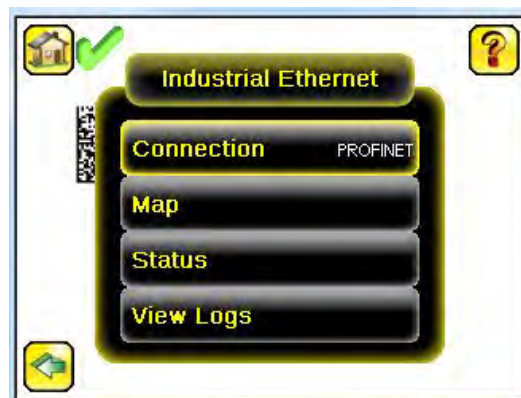

- Click on Map to configure the PROFINET module map.

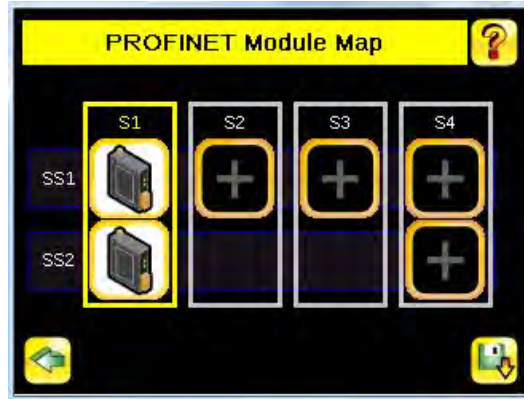

NOTE: The PROFINET module map displays S1 SS1 and S1 SS2 by default. S1 represents Slot 1, SS1 represents SubSlot 1; S2 represents Slot 2, SS2 represents SubSlot 2. The other slots are not configured by default.

The default PROFINET configuration consists of a single module plugged into Slot 1. This module, called the Device Control and Status Module, accepts two submodules: the Inspection Result Submodule, plugged into Subslot 1, and the Device Control Submodule, plugged into Subslot 2.

The Inspection Result Submodule provides the inspection results from the iVu Plus, including Pass Count, Fail Count, and Current Inspection Time. See [Table 24](#) on page 118



NOTE: The Inspection Result Submodule does not provide any barcode output data.

The Device Control Submodule allows the user to issue commands to the iVu Plus, such as Trigger, TEACH, and Product Change. This submodule also provides the user with command feedback. See [Table 25](#) on page 119

Adding sensor-specific output information, including data from decoded barcode symbols, requires the use of a BCR sensor output submodule, plugged into Slot 2 Subslot 1. The iVu Plus BCR provides different options for configuring this submodule, based on the space required by the decoded barcode data. The selection of sensor output submodules is based on size, allowing the user to control network bandwidth use.

Another optional addition to the configuration is called the Compare String Submodule, plugged into Slot 3 Subslot 1. This submodule allows the controller (PLC) to send new ASCII compare strings or string masks to the iVu Plus BCR. The selection of compare string submodules is based on the desired length of the compare string data used.

The iVu BCR Command Channel Module can be plugged into Slot 4. The selection of Command Channel Submodules is based on the required length of the data output string.

Follow Step 8 and Step 9 to add a submodule to the configuration (optional).

- Click on S2 to go to the configuration window and add a submodule .

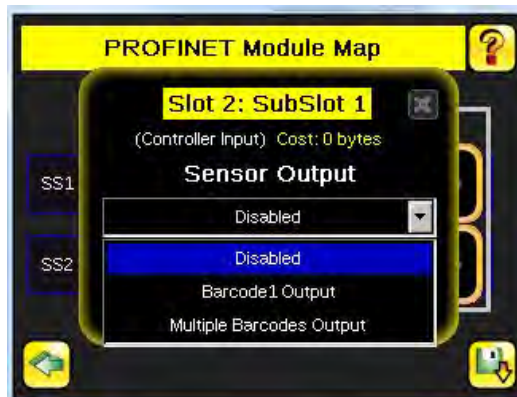

9. Click on the Drop-Down Arrow next to Disabled to open the list of submodule slots.
10. Select a submodule and hit enter.
The submodule slot now shows an icon, which means that it has been configured.
11. Set up all submodules for your application.

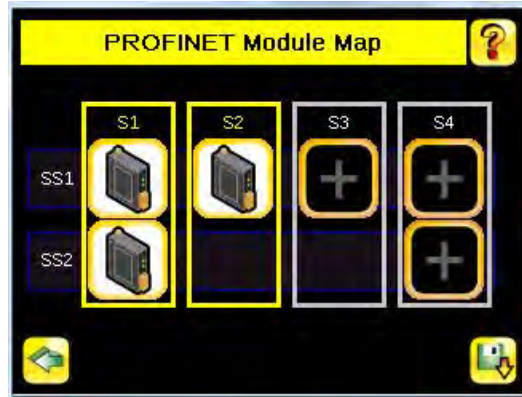

The iVu Plus PROFINET configuration is complete. The PLC can be configured to complete the PROFINET connection.

Description of Modules

Table 18: Assignment of Slots and Subslots

| | Slot 1 - BCR Control and Status Module | Slot 2 - BCR Sensor Output Module | Slot 3 - BCR Control Module | Slot 4 - Command Channel Module |
|-----------|--|-----------------------------------|-----------------------------|-------------------------------------|
| Subslot 1 | BCR Inspection Result Submodule | sensor output submodules | Compare String Submodule | Command Channel Command submodules |
| Subslot 2 | BCR Device Control Submodule | — | — | Command Channel Response submodules |

Table 19: BCR Control and Status Module (Ident 0x00000011)

| Number of Physical Subslots | Subslot Label | Subslot Number |
|-----------------------------|-------------------------------------|----------------|
| 1 | 1.1 BCR Inspection Result Submodule | 1 (0x1) |
| 1 | 1.2 BCR Device Control Submodule | 2 (0x2) |

Table 20: BCR Sensor Output Module (Ident 0x00000041)

| Number of Physical Subslots | Subslot Label | Subslot Number |
|-----------------------------|------------------------------|----------------|
| 1 | 2.1 sensor output submodules | 1 (0x1) |

Table 21: BCR Control Module (Ident 0x00000020)

| Number of Physical Subslots | Subslot Label | Subslot Number |
|-----------------------------|---------------------------|----------------|
| 1 | Compare String submodules | 1 (0x1) |

Table 22: Command Channel Module (Ident 0x00000030)

| Number of Physical Subslots | Subslot Label | Subslot Number |
|-----------------------------|---|----------------|
| 1 | 4.1 Command Channel Command submodules | 1 (0x1) |
| 1 | 4.2 Command Channel Response submodules | 2 (0x2) |

Description of Submodules

Table 23: Supported Submodules and Locations

| Submodules | Location | Notes |
|---|-------------------|---|
| BCR Inspection Result Submodule | Slot 1, Subslot 1 | Always present. |
| BCR Device Control Submodule | Slot 1, Subslot 2 | Present by default, but can be removed. |
| Sensor Output – First Barcode Submodule | Slot 2, Subslot 1 | There are six versions of this submodule supporting command strings of 16, 32, 64, 128, 256, and 512 bytes. |
| Sensor Output – Multiple Barcodes Submodule | Slot 2, Subslot 1 | Predefined with space for 10 barcodes. |
| Compare String Submodule | Slot 3, Subslot 1 | There are six versions of this submodule supporting command strings of 16, 32, 64, 128, 256, and 512 bytes. |
| Command Channel Command Submodule | Slot 4, subslot 1 | There are four versions of this submodule supporting command strings of 0, 32, 64, and 128 bytes. |
| Command Channel Response Submodule | Slot 4, subslot 2 | There are four versions of this submodule supporting command strings of 0, 32, 64, and 128 bytes. |

Inspection Result Submodule

The Inspection Result Submodule contains inspection results and sends input data to the controller (PLC). This submodule is plugged into Slot 1 Subslot 2 and cannot be removed.

Table 24: BCR Inspection Result Submodule (Ident 0x0102)

| PLC Input Data Name | Input Data Type | PLC Output Data Name | Output Data Type |
|-------------------------|-----------------|----------------------|------------------|
| Inspection Status Word | Unsigned16 | Not applicable | Not applicable |
| Inspection Number | Unsigned32 | | |
| Sensor Pass/Fail Status | Unsigned32 | | |
| Iteration Count | Unsigned32 | | |
| Pass Count | Unsigned32 | | |
| Fail Count | Unsigned32 | | |
| Missed Trigger Count | Unsigned32 | | |
| Current Inspection Time | Unsigned32 | | |

| Inspection Status Word | Function |
|------------------------------------|---------------------------|
| Bit Position for Cyclic Input Data | |
| Bit 0 | System Ready |
| Bit 1 | Inspection Pass/Fail |
| Bit 2 | Barcode Read/No Read |
| Bit 3 | Ready Signal Latch |
| Bit 4 | Output 1 ON/OFF |
| Bit 5 | Output 2 ON/OFF |
| Bit 6 | Output 3 ON/OFF |
| Bit 7 | Missed Trigger Occurrence |

Device Control Submodule

The Device Control Submodule contains controller (PLC) input and output data, including device controls for the iVu Plus. The user-enabled Device Control Submodule is optional and plugged into Slot 1 Subslot 2 by default. The user can remove it.

Table 25: BCR Device Control Submodule (Ident 0x0002)

| PLC Input Data Name | Input Data Type | PLC Output Data Name | Output Data Type |
|-------------------------|-----------------|-----------------------------|------------------|
| Device Control ACK Word | Unsigned16 | Device Control Command Word | Unsigned16 |
| Return Error Code | Unsigned32 | Product Change Number | Unsigned32 |

| Device Control ACK Word | | Device Control Command Word | |
|------------------------------------|--------------------------------|-------------------------------------|--------------------------------|
| Bit Position for Cyclic Input Data | Function | Bit Position for Cyclic Output Data | Function |
| Bit 0 | Product Change Acknowledgement | Bit 0 | Product Change Request |
| Bit 1 | Teach Latch Acknowledgement | Bit 1 | Teach Latch Request |
| Bit 2 | Trigger Acknowledgement | Bit 2 | Trigger Request |
| Bit 3 | Gated Trigger Acknowledgement | Bit 3 | Start of Gated Trigger Request |
| Bit 13 | Teach Error | | |
| Bit 14 | System Error | | |
| Bit 15 | Command Execution Error | | |

Sensor Output Submodules

The First Barcode Submodule contains barcode output data. This user-enabled submodule is optional and plugged into Slot 2 Subslot 1. The First Barcode Submodule has six versions with 16, 32, 64, 128, 256, and 512 bytes, depending on the length of the output string.

Table 26: 16-Byte First Barcode Submodule (Ident 0x00019)

| PLC Input Data Name | Input Data Type | PLC Output Data Name | Output Data Type |
|------------------------------------|---------------------|----------------------|------------------|
| Frame Number | Unsigned32 | Not applicable | Not applicable |
| Sensor type | Unsigned16 | | |
| Total number of barcodes found | Unsigned16 | | |
| Barcode 1 type | Unsigned16 | | |
| Actual length of barcode 1 data | Unsigned32 | | |
| Output length of barcode 1 data | Unsigned32 | | |
| 16-character barcode output string | 16-byte OctetString | | |

Table 27: 32-Byte First Barcode Submodule (Ident 0x00020)

| PLC Input Data Name | Input Data Type | PLC Output Data Name | Output Data Type |
|------------------------------------|---------------------|----------------------|------------------|
| Frame number | Unsigned32 | Not applicable | Not applicable |
| Sensor type | Unsigned16 | | |
| Total number of barcodes found | Unsigned16 | | |
| Barcode 1 type | Unsigned16 | | |
| Actual length of barcode 1 data | Unsigned16 | | |
| Output length of barcode 1 data | Unsigned32 | | |
| 32-character barcode output string | 32-byte OctetString | | |

Table 28: 64-Byte First Barcode Submodule (Ident 0x00021)

| PLC Input Data Name | Input Data Type | PLC Output Data Name | Output Data Type |
|------------------------------------|---------------------|----------------------|------------------|
| Frame number | Unsigned32 | Not applicable | Not applicable |
| Sensor type | Unsigned16 | | |
| Total number of barcodes found | Unsigned16 | | |
| Barcode 1 type | Unsigned16 | | |
| Actual length of barcode 1 data | Unsigned16 | | |
| Output length of barcode 1 data | Unsigned32 | | |
| 64-character barcode output string | 64-byte OctetString | | |

Table 29: 128-Byte First Barcode Submodule (Ident 0x00022)

| PLC Input Data Name | Input Data Type | PLC Output Data Name | Output Data Type |
|-------------------------------------|----------------------|----------------------|------------------|
| Frame number | Unsigned32 | Not applicable | Not applicable |
| Sensor type | Unsigned16 | | |
| Total number of barcodes found | Unsigned16 | | |
| Barcode 1 type | Unsigned16 | | |
| Actual length of barcode 1 data | Unsigned16 | | |
| Output length of barcode 1 data | Unsigned32 | | |
| 128-character barcode output string | 128-byte OctetString | | |

Table 30: 256-Byte First Barcode Submodule (Ident 0x00023)

| PLC Input Data Name | Input Data Type | PLC Output Data Name | Output Data Type |
|-------------------------------------|----------------------|----------------------|------------------|
| Frame number | Unsigned32 | Not applicable | Not applicable |
| Sensor type | Unsigned16 | | |
| Total number of barcodes found | Unsigned16 | | |
| Barcode 1 type | Unsigned16 | | |
| Actual length of barcode 1 data | Unsigned16 | | |
| Output length of barcode 1 data | Unsigned32 | | |
| 256-character barcode output string | 256-byte OctetString | | |

Table 31: 512-Byte First Barcode Submodule (Ident 0x00024)

| PLC Input Data Name | Input Data Type | PLC Output Data Name | Output Data Type |
|-------------------------------------|----------------------|----------------------|------------------|
| Frame number | Unsigned32 | Not applicable | Not applicable |
| Sensor type | Unsigned16 | | |
| Total number of barcodes found | Unsigned16 | | |
| Barcode 1 type | Unsigned16 | | |
| Actual length of barcode 1 data | Unsigned16 | | |
| Output length of barcode 1 data | Unsigned32 | | |
| 512-character barcode output string | 512-byte OctetString | | |

The Multiple Barcodes Submodule is predefined and contains barcode output data. This submodule has space for ten individual barcodes.

Table 32: Multiple Barcodes Submodule (Ident 0x00026)

| PLC Input Data Name | Input Data Type | PLC Output Data Name | Output Data Type |
|------------------------------------|---------------------|----------------------|------------------|
| Frame number | Unsigned32 | Not applicable | Not applicable |
| Sensor type | Unsigned16 | | |
| Total number of barcodes found | Unsigned16 | | |
| Barcode 1 type | Unsigned16 | | |
| Actual length of barcode 1 data | Unsigned16 | | |
| Output length of barcode 1 data | Unsigned32 | | |
| 32-character barcode output string | 32-byte OctetString | | |
| Barcode 2 type | Unsigned16 | | |
| Actual length of barcode 2 data | Unsigned16 | | |
| Output length of barcode 2 data | Unsigned32 | | |
| 32-character barcode output string | 32-byte OctetString | | |
| Barcode 3 type | Unsigned16 | | |
| Actual length of barcode 3 data | Unsigned16 | | |
| Output length of barcode 3 data | Unsigned32 | | |
| 32-character barcode output string | 32-byte OctetString | | |
| Barcode 4 type | Unsigned16 | | |
| Actual length of barcode 4 data | Unsigned16 | | |
| Output length of barcode 4 data | Unsigned32 | | |
| 32-character barcode output string | 32-byte OctetString | | |
| Barcode 5 type | Unsigned16 | | |
| Actual length of barcode 5 data | Unsigned16 | | |
| Output length of barcode 5 data | Unsigned32 | | |
| 32-character barcode output string | 32-byte OctetString | | |
| Barcode 6 type | Unsigned16 | | |
| Actual length of barcode 6 data | Unsigned16 | | |
| Output length of barcode 6 data | Unsigned32 | | |
| 32-character barcode output string | 32-byte OctetString | | |
| Barcode 7 type | Unsigned16 | | |
| Actual length of barcode 7 data | Unsigned16 | | |
| Output length of barcode 7 data | Unsigned32 | | |
| 32-character barcode output string | 32-byte OctetString | | |
| Barcode 8 type | Unsigned16 | | |
| Actual length of barcode 8 data | Unsigned16 | | |
| Output length of barcode 8 data | Unsigned32 | | |
| 32-character barcode output string | 32-byte OctetString | | |
| Barcode 9 type | Unsigned16 | | |
| Actual length of barcode 9 data | Unsigned16 | | |
| Output length of barcode 9 data | Unsigned32 | | |
| 32-character barcode output string | 32-byte OctetString | | |
| Barcode 10 type | Unsigned16 | | |
| Actual length of barcode 10 data | Unsigned16 | | |
| Output length of barcode 10 data | Unsigned32 | | |
| 32-character barcode output string | 32-byte OctetString | | |

Compare String Submodules

The Compare String Submodules contain controller input and controller output data, as well as BCR controls. This user-enabled submodule is optional and plugged into Slot 3 Subslot 1. The Compare String Submodule has six versions, depending on the length of the compare string.

Table 33: 16-Byte Compare String Submodule (Ident 0x0004)

| PLC Input Data Name | Input Data Type | PLC Output Data Name | Output Data Type |
|--|-----------------|---|---------------------|
| Return status code of the string or mask-set operation | Unsigned16 | BCR control word | Unsigned16 |
| String or mask-set operation error code | Unsigned32 | Length-of-barcode compare string or mask, up to 16 characters | Unsigned32 |
| | | Maximum 16-character barcode compare string or mask | 16-byte OctetString |

| Bit Position for Cyclic Input Data | Function | Bit Position for Cyclic Output Data | Function |
|------------------------------------|--|-------------------------------------|------------------------------------|
| Bit 0 | Set Barcode Compare String Acknowledgement | Bit 0 | Set Barcode Compare String Request |
| Bit 1 | Set Barcode Compare Mask Acknowledgement | Bit 1 | Set Barcode Compare Mask Request |

Table 34: 32-Byte Compare String Submodule (0x0005)

| PLC Input Data Name | Input Data Type | PLC Output Data Name | Output Data Type |
|--|-----------------|---|---------------------|
| Return status code of the string or mask-set operation | Unsigned16 | BCR control word | Unsigned16 |
| String or mask-set operation error code | Unsigned32 | Length-of-barcode compare string or mask, up to 32 characters | Unsigned32 |
| | | Maximum 32-character barcode compare string or mask | 64-byte OctetString |

| Bit Position for Cyclic Input Data | Function | Bit Position for Cyclic Output Data | Function |
|------------------------------------|--|-------------------------------------|------------------------------------|
| Bit 0 | Set Barcode Compare String Acknowledgement | Bit 0 | Set Barcode Compare String Request |
| Bit 1 | Set Barcode Compare Mask Acknowledgement | Bit 1 | Set Barcode Compare Mask Request |

Table 35: 64-Byte Compare String Submodule (Ident 0x0006)

| PLC Input Data Name | Input Data Type | PLC Output Data Name | Output Data Type |
|--|-----------------|---|---------------------|
| Return status code of the string or mask-set operation | Unsigned16 | BCR control word | Unsigned16 |
| String or mask-set operation error code | Unsigned32 | Length-of-barcode compare string or mask, up to 64 characters | Unsigned32 |
| | | Maximum 64-character barcode compare string or mask | 64-byte OctetString |

| Bit Position for Cyclic Input Data | Function | Bit Position for Cyclic Output Data | Function |
|------------------------------------|--|-------------------------------------|------------------------------------|
| Bit 0 | Set Barcode Compare String Acknowledgement | Bit 0 | Set Barcode Compare String Request |
| Bit 1 | Set Barcode Compare Mask Acknowledgement | Bit 1 | Set Barcode Compare Mask Request |

Table 36: 128-Byte Compare String Submodule (Ident 0x0007)

| PLC Input Data Name | Input Data Type | PLC Output Data Name | Output Data Type |
|--|-----------------|--|----------------------|
| Return status code of the string or mask-set operation | Unsigned16 | BCR control word | Unsigned16 |
| String or mask-set operation error code | Unsigned32 | Length-of-barcode compare string or mask, up to 128 characters | Unsigned32 |
| | | Maximum 128-character barcode compare string or mask | 128-byte OctetString |

| Bit Position for Cyclic Input Data | Function | Bit Position for Cyclic Output Data | Function |
|------------------------------------|--|-------------------------------------|------------------------------------|
| Bit 0 | Set Barcode Compare String Acknowledgement | Bit 0 | Set Barcode Compare String Request |
| Bit 1 | Set Barcode Compare Mask Acknowledgement | Bit 1 | Set Barcode Compare Mask Request |

Table 37: 256-Byte Compare String Submodule (Ident 0x0008)

| PLC Input Data Name | Input Data Type | PLC Output Data Name | Output Data Type |
|--|-----------------|--|----------------------|
| Return status code of the string or mask-set operation | Unsigned16 | BCR control word | Unsigned16 |
| String or mask-set operation error code | Unsigned32 | Length-of-barcode compare string or mask, up to 256 characters | Unsigned32 |
| | | Maximum 256-character barcode compare string or mask | 256-byte OctetString |

| Bit Position for Cyclic Input Data | Function | Bit Position for Cyclic Output Data | Function |
|------------------------------------|--|-------------------------------------|------------------------------------|
| Bit 0 | Set Barcode Compare String Acknowledgement | Bit 0 | Set Barcode Compare String Request |
| Bit 1 | Set Barcode Compare Mask Acknowledgement | Bit 1 | Set Barcode Compare Mask Request |

Table 38: 512-Byte Compare String Submodule (Ident 0x0009)

| PLC Input Data Name | Input Data Type | PLC Output Data Name | Output Data Type |
|--|-----------------|--|----------------------|
| Return status code of the string or mask-set operation | Unsigned16 | BCR control word | Unsigned16 |
| String or mask-set operation error code | Unsigned32 | Length-of-barcode compare string or mask, up to 512 characters | Unsigned32 |
| | | Maximum 512-character barcode compare string or mask | 512-byte OctetString |

| Bit Position for Cyclic Input Data | Function | Bit Position for Cyclic Output Data | Function |
|------------------------------------|--|-------------------------------------|------------------------------------|
| Bit 0 | Set Barcode Compare String Acknowledgement | Bit 0 | Set Barcode Compare String Request |
| Bit 1 | Set Barcode Compare Mask Acknowledgement | Bit 1 | Set Barcode Compare Mask Request |

Command Channel Command Submodules

The Command Channel Command Submodules contain controller (PLC) output data and command channel request data. The user-enabled submodules are optional. On the iVu Plus BCR Gen2 device the submodule is plugged into Slot 4 Subslot 1.

The Command Channel Command Submodule has four versions with 16, 32, 64, or 128 bytes, depending on the required length of the input string.

Table 39: Numeric Command Submodule (Ident 0x00012)

| PLC Output Data Name | Output Data Type | PLC Input Data Name | Input Data Type |
|--|------------------|---------------------|-----------------|
| Flag indicates when to apply the command | Unsigned16 | Not applicable | Not applicable |
| Numeric ID of the command | Unsigned16 | | |
| 16-bit integer command argument | Unsigned16 | | |
| 32-bit integer command argument | Unsigned32 | | |
| Floating-point command argument | Float32 | | |

| Flag indicates when to apply the command | Bit Position for Cyclic Output Data | Function |
|--|-------------------------------------|---------------------------------|
| | Bit 0 | Command Channel Command Request |

Table 40: 32-Character Text Command Submodule (Ident 0x00013)

| PLC Output Data Name | Output Data Type | PLC Input Data Name | Input Data Type |
|--|---------------------|---------------------|-----------------|
| Flag indicates when to apply the command | Unsigned16 | Not applicable | Not applicable |
| Numeric ID of the command | Unsigned16 | | |
| 16-bit integer command argument | Unsigned16 | | |
| 32-bit integer command argument | Unsigned32 | | |
| Floating-point command argument | Float32 | | |
| Length-of-Command/Response string | Unsigned32 | | |
| 32-character command string | 32-byte OctetString | | |

| Flag indicates when to apply the command | |
|--|---------------------------------|
| Bit Position for Cyclic Output Data | Function |
| Bit 0 | Command Channel Command Request |

Table 41: 64-Character Text Command Submodule (Ident 0x00014)

| PLC Output Data Name | Output Data Type | PLC Input Data Name | Input Data Type |
|--|---------------------|---------------------|-----------------|
| Flag indicates when to apply the command | Unsigned16 | Not applicable | Not applicable |
| Numeric ID of the command | Unsigned16 | | |
| 16-bit integer command argument | Unsigned16 | | |
| 32-bit integer command argument | Unsigned32 | | |
| Floating-point command argument | Float32 | | |
| Length-of-Command/Response string | Unsigned32 | | |
| 64-character command string | 64-byte OctetString | | |

| Flag indicates when to apply the command | |
|--|---------------------------------|
| Bit Position for Cyclic Output Data | Function |
| Bit 0 | Command Channel Command Request |

Table 42: 128-Character Text Command Submodule (Ident 0x00015)

| PLC Output Data Name | Output Data Type |
|--|----------------------|
| Flag indicates when to apply the command | Unsigned16 |
| Numeric ID of the command | Unsigned16 |
| 16-bit integer command argument | Unsigned16 |
| 32-bit integer command argument | Unsigned32 |
| Floating-point command argument | Float32 |
| Length-of-Command/Response string | Unsigned32 |
| 128-character command string | 128-byte OctetString |

| PLC Input Data Name | Input Data Type |
|---------------------|-----------------|
| Not applicable | Not applicable |

| Flag indicates when to apply the command | |
|--|---------------------------------|
| Bit Position for Cyclic Output Data | Function |
| Bit 0 | Command Channel Command Request |

Command Channel Response Submodules

The Command Channel Response Submodules contain only controller (PLC) input data and command channel response data. The user-enabled submodules are optional. On the iVu Plus BCR model the submodule is plugged into Slot 4 Subslot 2.

The Command Channel Response Submodule has four versions with 16, 32, 64, or 128 bytes, depending on the required length of the data output string.

Table 43: Numeric Response Submodule (Ident 0x00050)

| PLC Input Data Name | Input Data Type |
|---------------------------------|-----------------|
| Numeric Command Status | Unsigned16 |
| 16-bit integer command response | Unsigned16 |
| 32-bit integer command response | Unsigned32 |
| Floating-point command argument | Float32 |

| PLC Output Data Name | Output Data Type |
|----------------------|------------------|
| Not applicable | Not applicable |

| Numeric Command Status | |
|------------------------------------|--|
| Bit Position for Cyclic Input Data | Function |
| Bit 0 | Command Channel Command Acceptance Acknowledgement |
| Bit 15 | Command Execution Error |

Table 44: 32-Character Text Response Submodule (Ident 0x00051)

| PLC Input Data Name | Input Data Type | PLC Output Data Name | Output Data Type |
|--------------------------------------|---------------------|----------------------|------------------|
| Numeric Command Status | Unsigned16 | Not applicable | Not applicable |
| 16-bit integer command response | Unsigned16 | | |
| 32-bit integer command response | Unsigned32 | | |
| Floating-point command argument | Float32 | | |
| Length-of-Command/Response string | Unsigned32 | | |
| 32-character command response string | 32-byte OctetString | | |

| Numeric Command Status | |
|------------------------------------|--|
| Bit Position for Cyclic Input Data | Function |
| Bit 0 | Command Channel Command Acceptance Acknowledgement |
| Bit 15 | Command Execution Error |

Table 45: 64-Character Text Response Submodule (Ident 0x00052)

| PLC Input Data Name | Input Data Type | PLC Output Data Name | Output Data Type |
|--------------------------------------|---------------------|----------------------|------------------|
| Numeric Command Status | Unsigned16 | Not applicable | Not applicable |
| 16-bit integer command response | Unsigned16 | | |
| 32-bit integer command response | Unsigned32 | | |
| Floating-point command argument | Float32 | | |
| Length-of-Command/Response string | Unsigned32 | | |
| 64-character command response string | 64-byte OctetString | | |

| Numeric Command Status | |
|------------------------------------|--|
| Bit Position for Cyclic Input Data | Function |
| Bit 0 | Command Channel Command Acceptance Acknowledgement |
| Bit 15 | Command Execution Error |

Table 46: 128-Character Text Response Submodule (Ident 0x00053)

| PLC Input Data Name | Input Data Type | PLC Output Data Name | Output Data Type |
|---------------------------------------|-------------------------|----------------------|------------------|
| Numeric Command Status | Unsigned16 | Not applicable | Not applicable |
| 16-bit integer command response | Unsigned16 | | |
| 32-bit integer command response | Unsigned32 | | |
| Floating-point command argument | Float32 | | |
| Length-of-Command/Response string | Unsigned32 | | |
| 128-character command response string | 128-byte OctetString | | |

| Numeric Command Status | |
|------------------------------------|--|
| Bit Position for Cyclic Input Data | Function |
| Bit 0 | Command Channel Command Acceptance Acknowledgement |
| Bit 15 | Command Execution Error |

7.7.3 Configuration Instructions

Using Siemens TIA Portal (v13) Software

Installing the Banner iVu Plus GSD File

Use these instructions to install the Banner iVu Plus GSD file in the Siemens TIA Portal (v13) software. Use these instructions as a basis for installing the Banner iVu Plus GSD file in another controller (PLC).

1. Download the Banner iVu Plus GSD file from www.bannerengineering.com.
2. Start the Siemens TIA Portal (v13) software.
3. Click Open existing project.
4. Select a project and open it.

5. Click Devices & networks when the project has been uploaded.

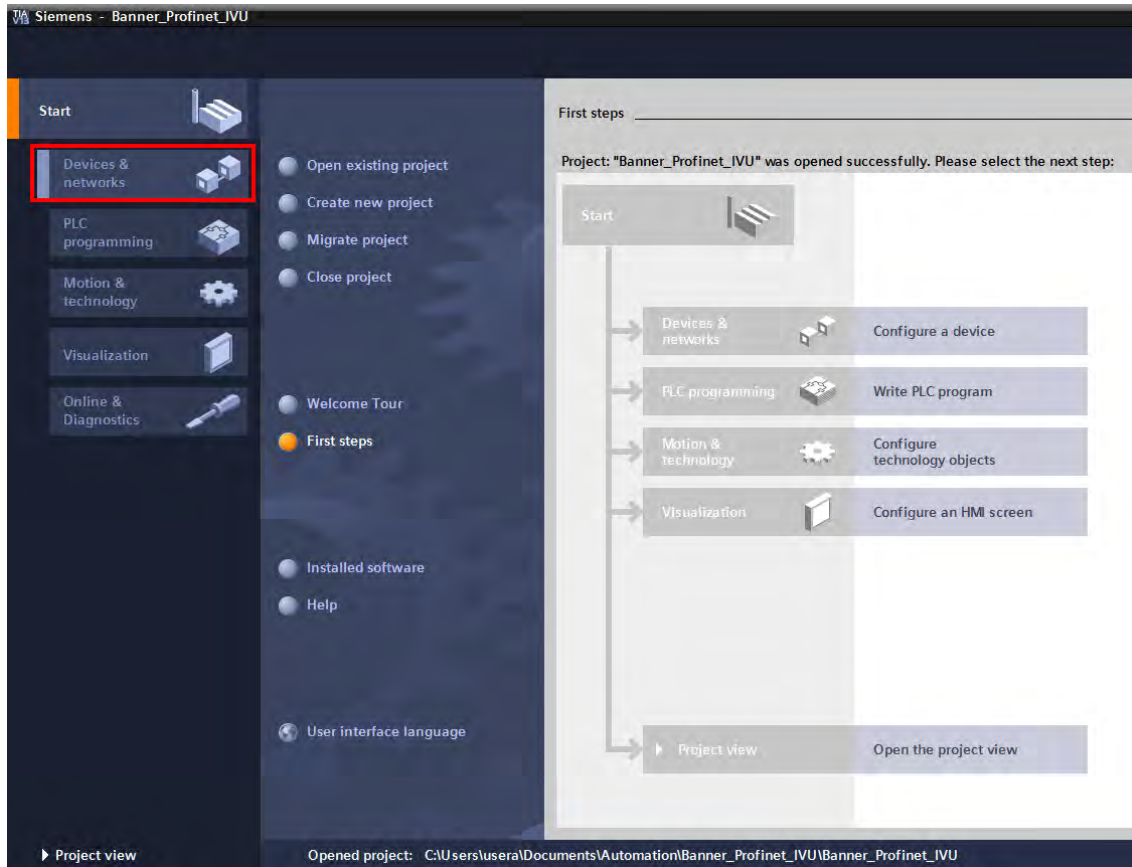

6. Click Configure networks.

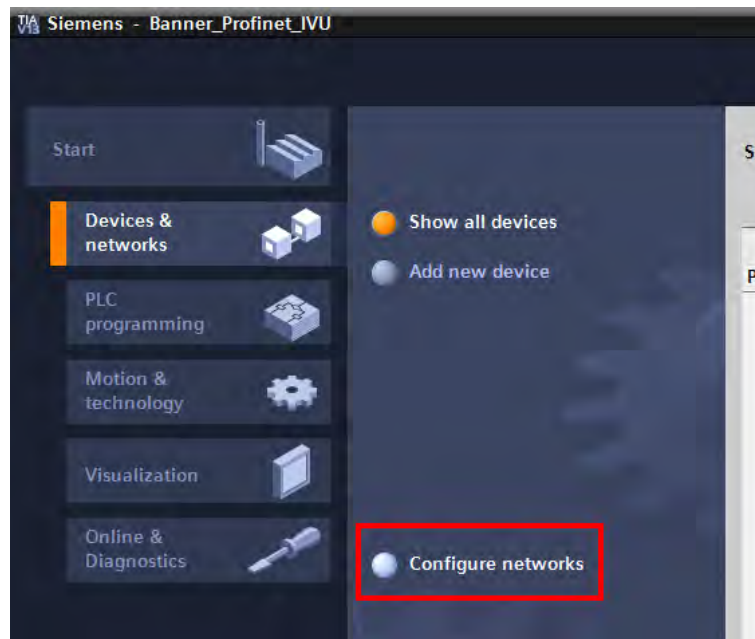

Network view displays.

7. Click Options and select Install general station description file (GSD).

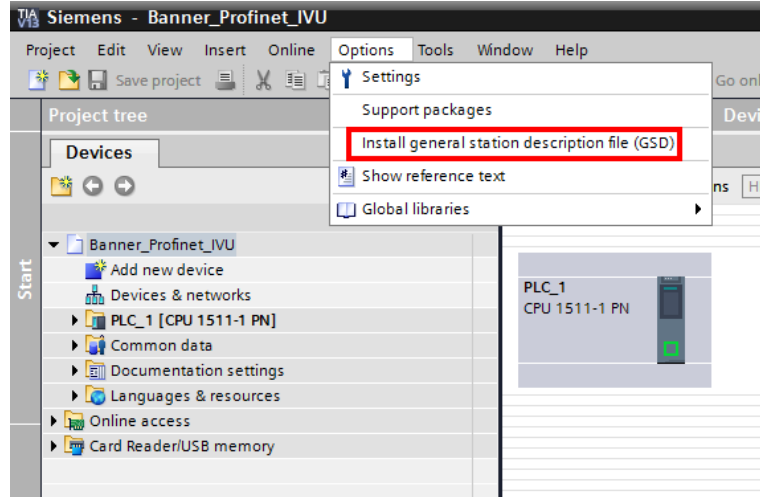

The Install general station description file window opens.

8. Click the browse button (...) to the right of the Source path field.

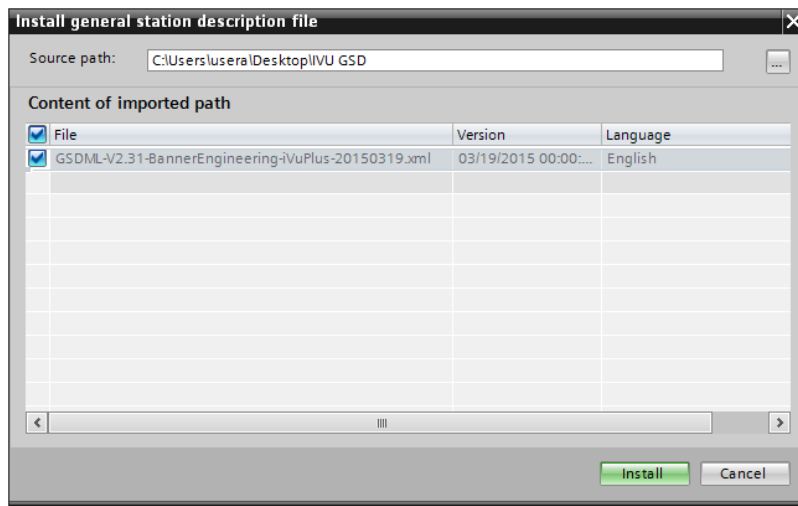

9. Navigate to the location the iVu Plus GSD file was downloaded to.
 10. Select the downloaded iVu Plus GSD file.

11. Click Install.

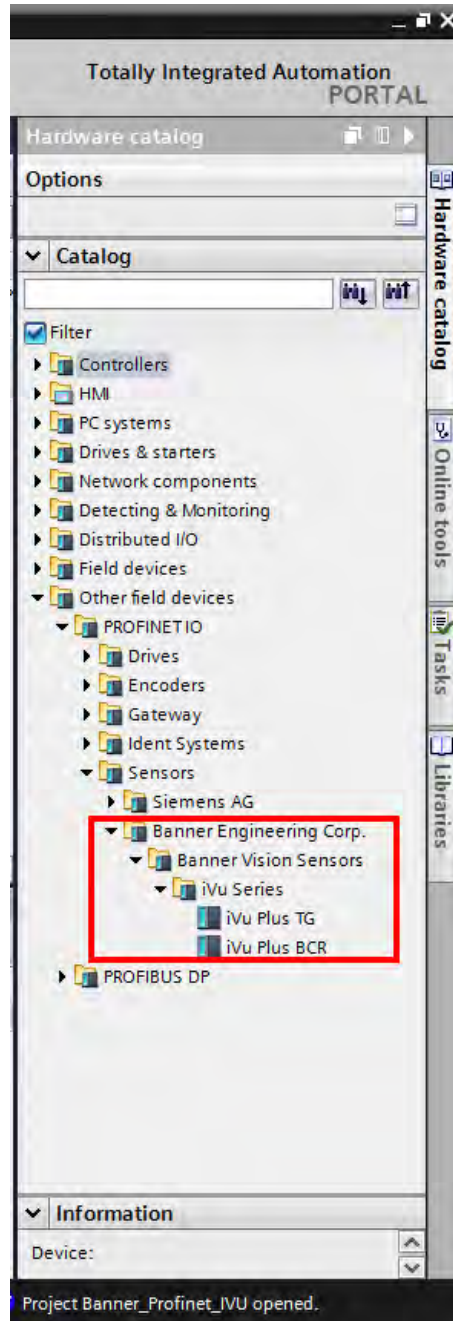

The system installs the iVu Plus GSD file and places it in the Hardware catalog. In the above example, the iVu Plus GSD file is located under Other field devices > PROFINET IO > Sensors > Banner Engineering Corp. > Banner Vision Sensors > iVu Series.



NOTE: If the iVu Plus GSD file does not install properly, save the log and contact Banner Engineering Corporation.

Adding a Device to a Project

Use these instructions to add an iVu Plus BCR device to a Siemens TIA Portal (v13) project, and to configure the device. Use these instructions as a basis for adding an iVu Plus BCR device to another controller (PLC).

1. Start the Siemens TIA Portal (v13) software.
2. Click Open existing project.
3. Select a project and open it.

4. Click Devices & networks when the project has been uploaded.

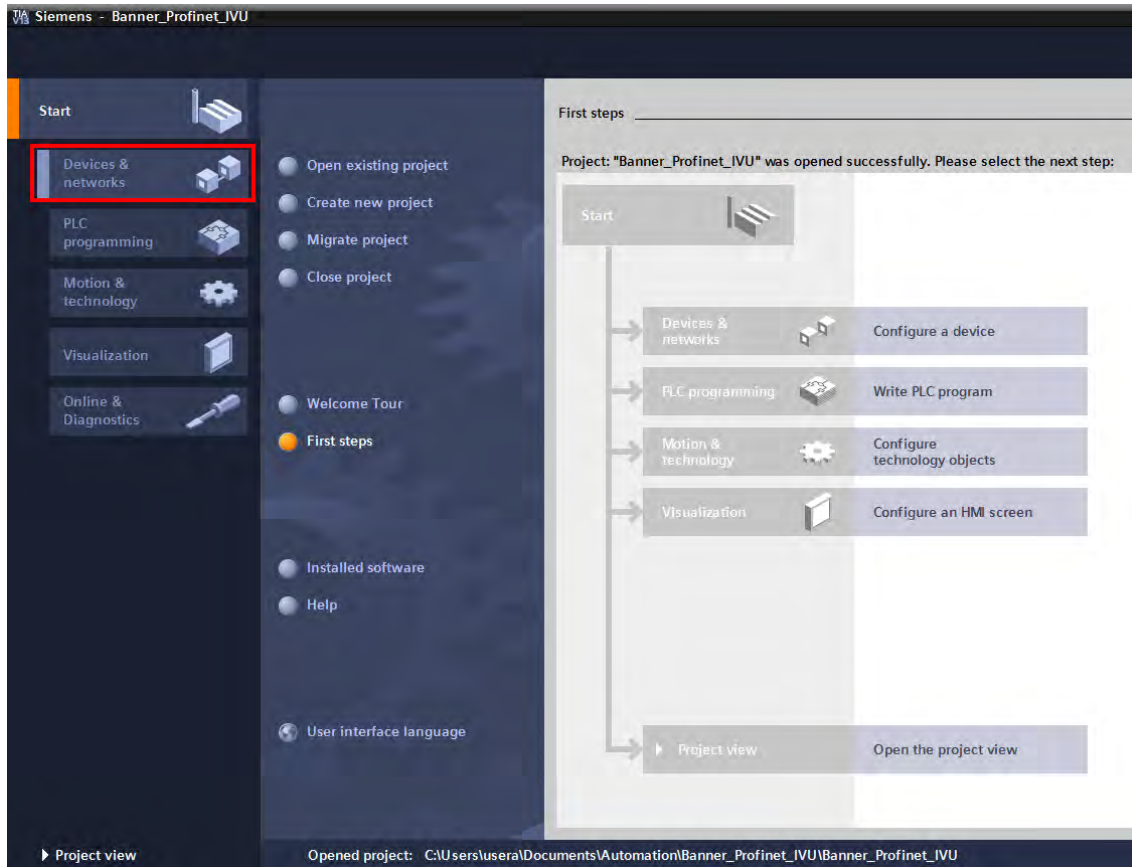

5. Click Configure networks.

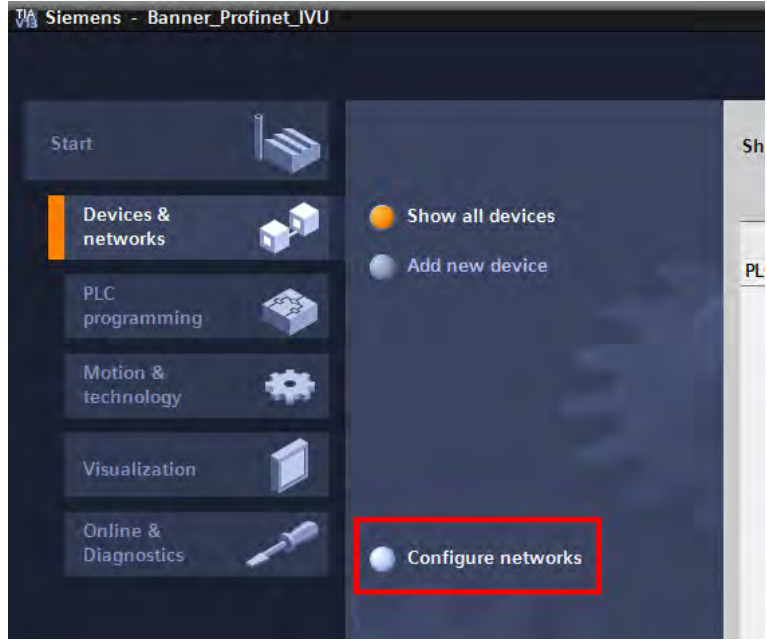

Network view displays.



NOTE: For Step 6 through Step 10, Network view must be open.

6. Locate iVu Plus BCR in the Hardware catalog.

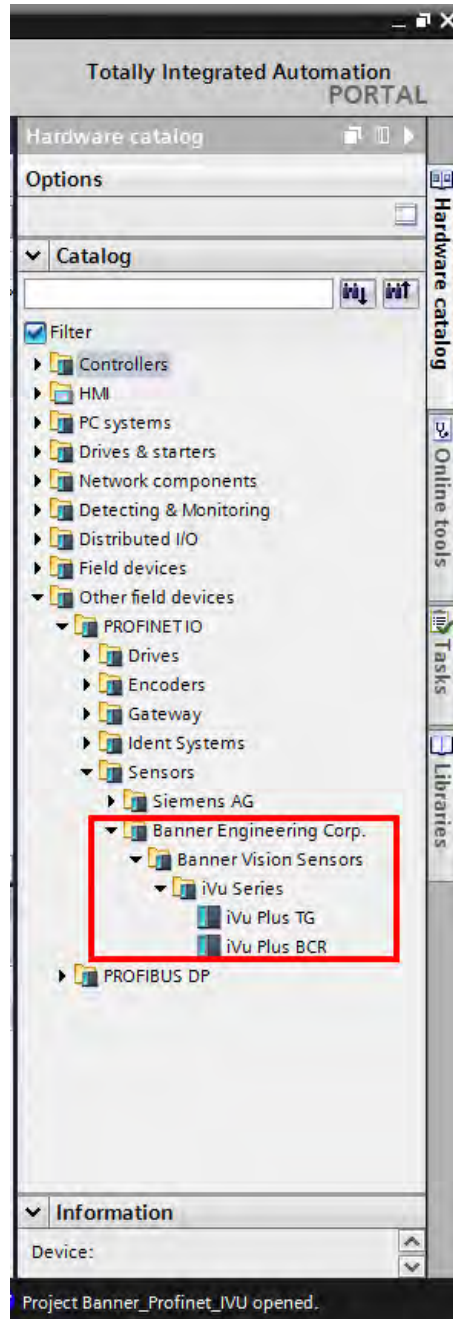

In the above example, the iVu Plus device is located under Other field devices > PROFINET IO > Sensors > Banner Engineering Corp. > Banner Vision Sensors > iVu Series.

7. Select the device and add it to the configuration.

| Selection Option | Description |
|------------------|--|
| Drag | Drag iVu Plus BCR from the Hardware catalog directly into the configuration. |
| Double-click | Double-click on iVu Plus BCR and add it to the configuration. |

- Click the green square on the iVu Plus BCR icon. Drag the pointer to the green square on the PLC_1 icon to connect the device to the controller (PLC).

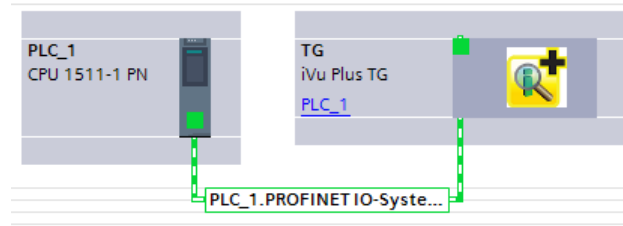

The connection is made.

- Double-click the iVu Plus BCR icon to open the Device window.
- Select the desired modules or submodules from the Hardware catalog and drag them onto the Device overview tab on the Device view tab. The iVu Plus device is configured.

Changing the Device IP Address

Use these instructions to change the IP address of the iVu Plus BCR device, using the Siemens TIA Portal (v13) software. Use these instructions as a basis if you are using another controller (PLC).

- Start the Siemens TIA Portal (v13) software.
- Click Open existing project.
- Select a project and open it.
- Click Devices & networks when the project has been uploaded to go to Network view.

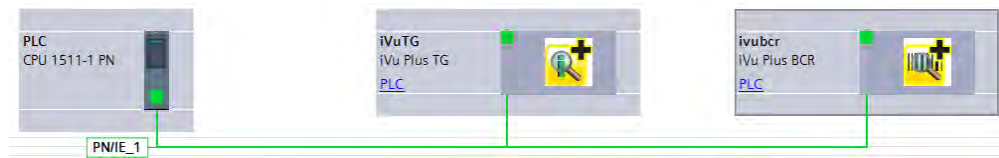

Network View displays.

- Double-click on the iVu Plus BCR icon to bring up the Device view.
- Click on the iVu Plus icon in the graphic area of the Device view to bring up the Module properties window. The module can now be configured.
- Click Properties.
- Click General.
- Select PROFINET interface > Ethernet addresses.

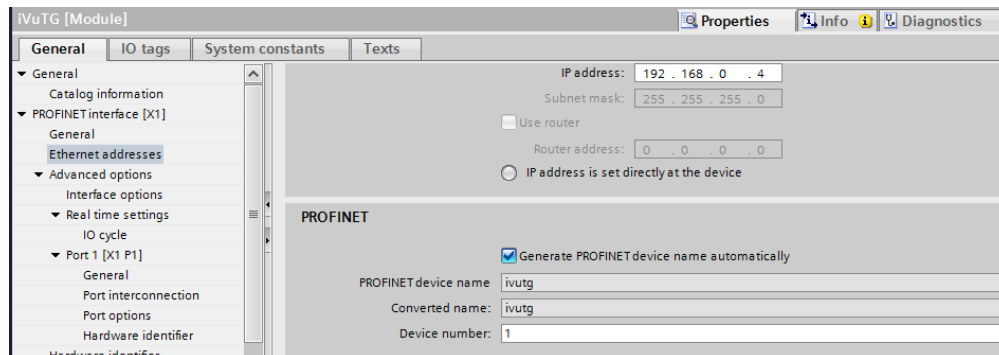

10. Select Set IP address in the project.

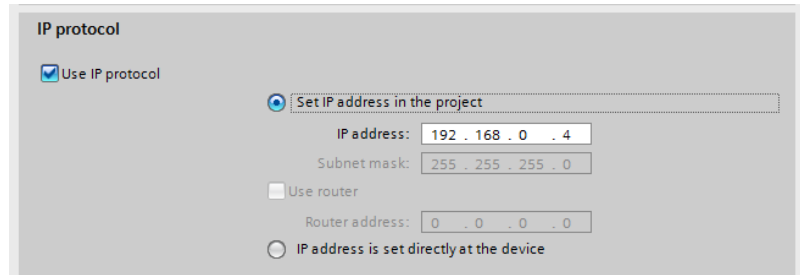

The project sets the IP address of the device.

11. Enter the IP address.

12. Right-click on the device icon and select Online & diagnostics.

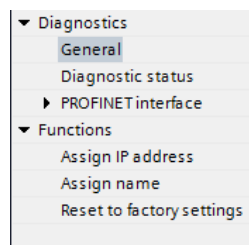
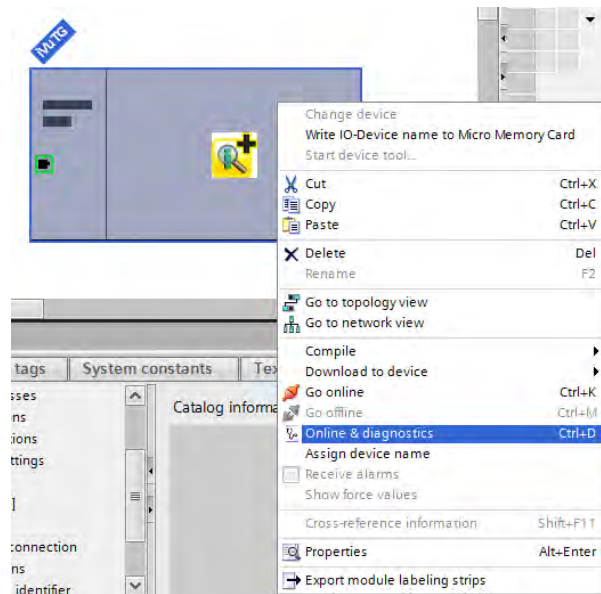

The Online & diagnostics window displays.

13. Select Assign IP address under Functions.

14. Click Accessible devices.

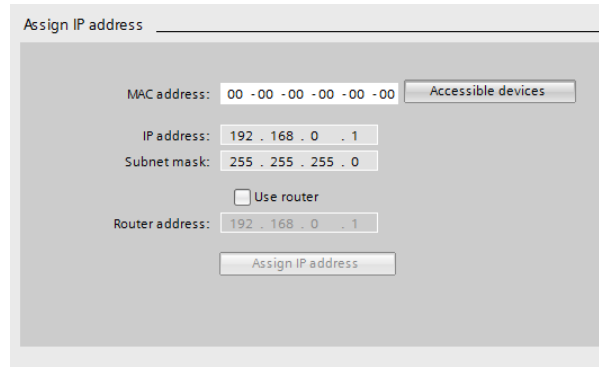

The Select device window searches the network for available devices.

15. Determine the device to be adjusted via the MAC address and select it.



NOTE: Use the iVu Plus touch screen to find the MAC address. Main Menu > System > Communications > Ethernet IO > Status

16. Click Apply.

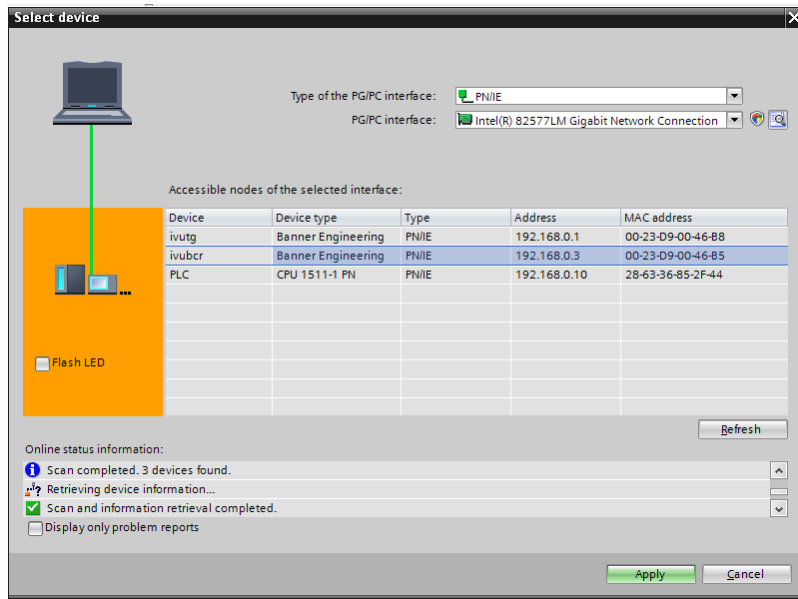

The IP address for the device is updated.

17. Click Assign IP address to complete the step.

This step is completed for every device.

Changing the Device Name

Use these instructions to change the name of the iVu Plus BCR device, using the Siemens TIA Portal (v13) software. Use these instructions as a basis if you are using another controller (PLC).

1. Open a project and click on Devices & networks to go to the Network view.

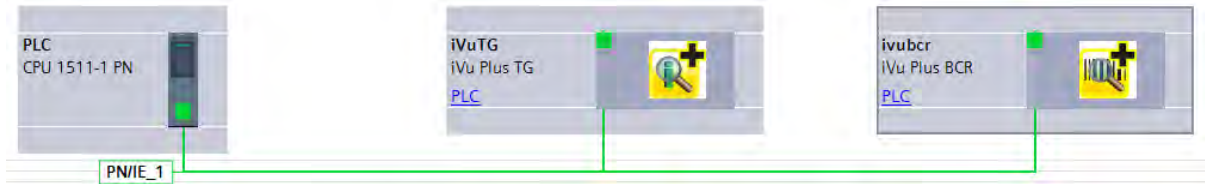

Network view displays.

2. Double-click on the iVu Plus BCR icon to bring up Device view.
3. Click on the iVu Plus icon in the graphic area of Device view to bring up the Module properties window.
4. Click General.
5. Select PROFINET interface [X1] > Ethernet addresses.

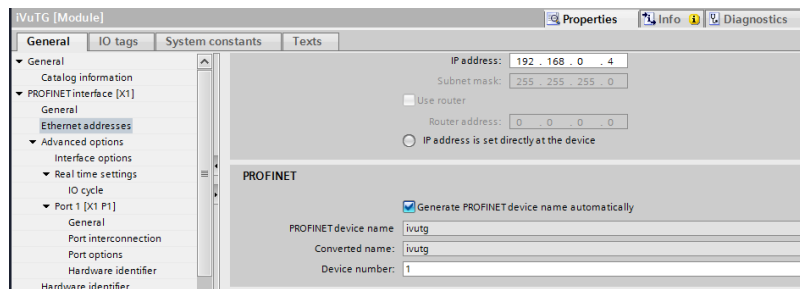

6. Deselect Generate PROFINET device name automatically.

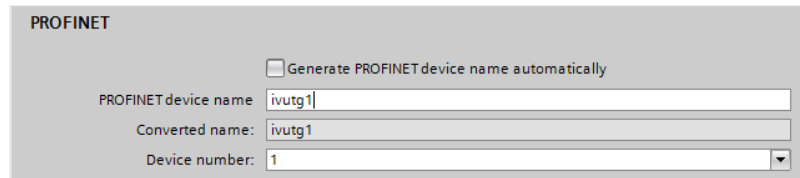

7. Enter a unique name in the PROFINET device name field.
8. Enter a unique device number in the Device number field.



NOTE: Each device number is used only once.

9. Right-click on the device icon and select Online & diagnostics.

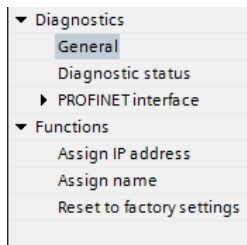
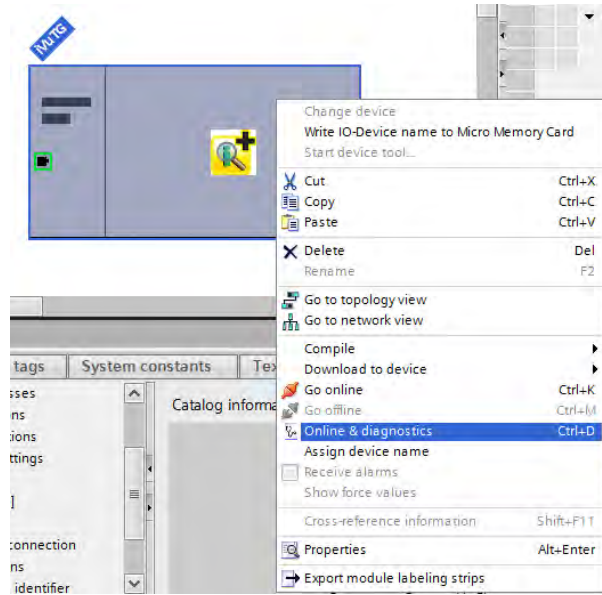

The Online & diagnostics window displays.
10. Select Assign name under Functions.

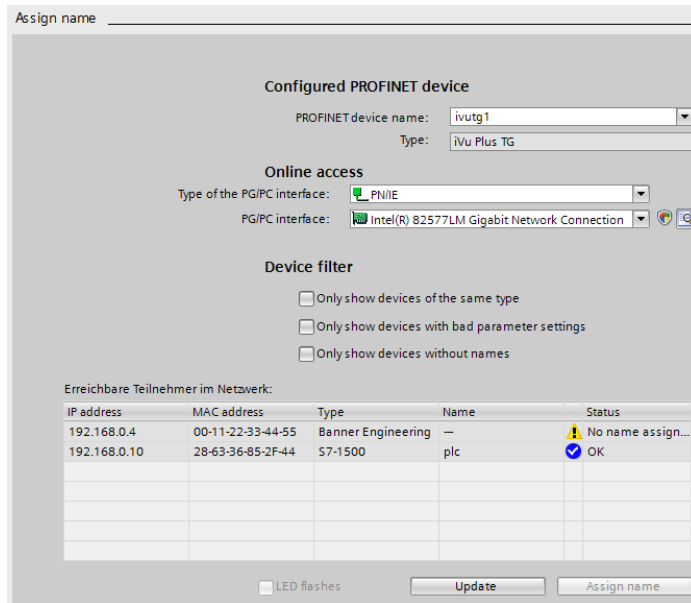

The Assign name window displays. The devices in the network are discovered. The Name column is blank.
11. Select the device that will have a name assigned to it.

12. Click Assign name to start the process.

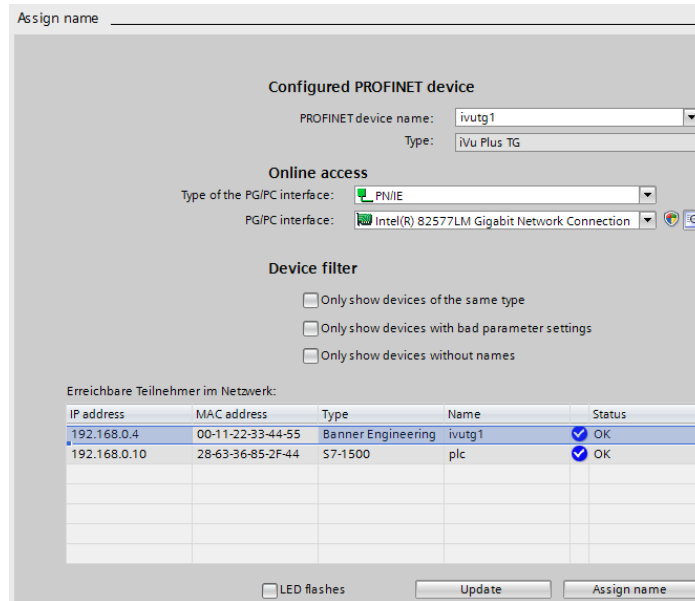

The name is assigned.

Using Siemens SIMATIC STEP 7 (v5.5) Software

Installing the Banner iVu Plus GSD File

Use these instructions to install the Banner iVu Plus GSD file in the Siemens SIMATIC STEP 7 (v5.5) software.

1. Start Siemens SIMATIC Manager.
2. Select an existing project and open it.
3. Select the Station (PLC) from the Object Hierarchy list.

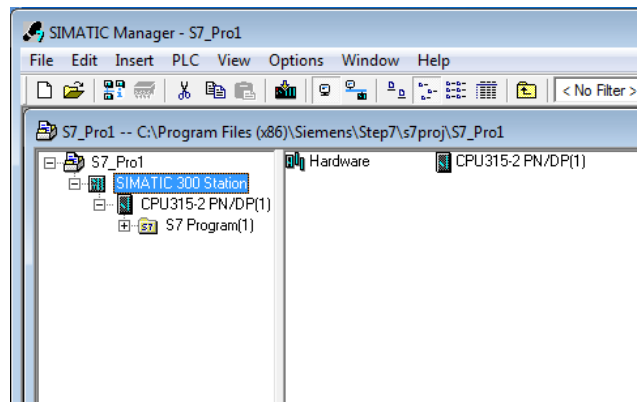

- 4. Double-click the Hardware icon in the Station level window.

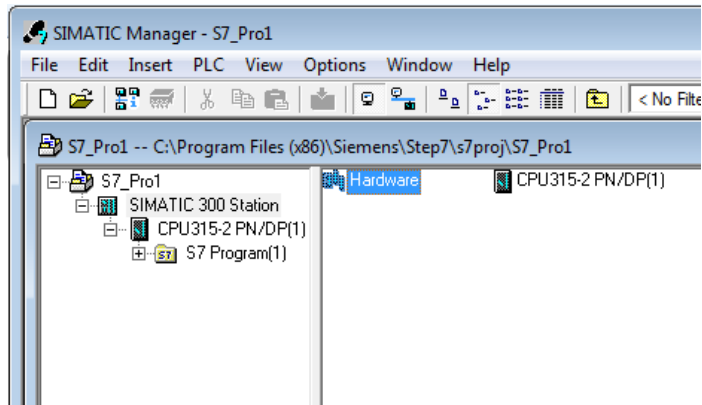

The Hardware configuration window opens.

- 5. In the Hardware configuration window, click Options > Install GSD File....

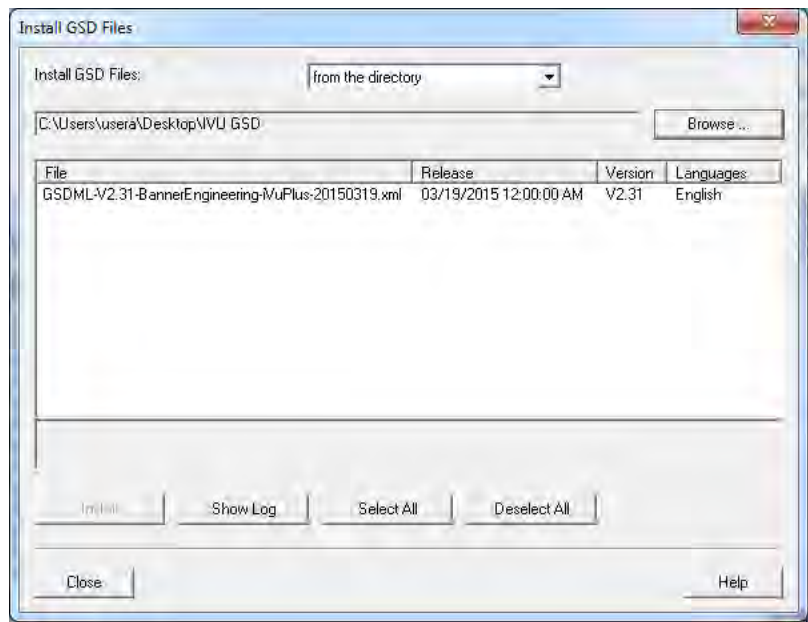
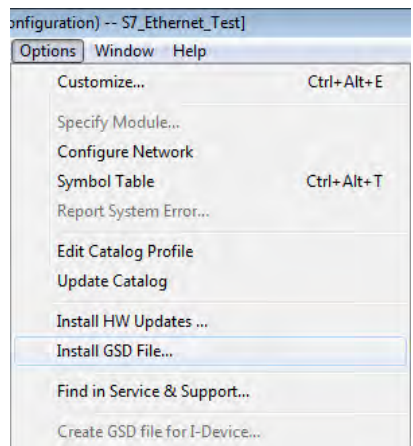

The Install GSD Files window displays.

- 6. Browse to the location of the saved Banner iVu Plus GSD file.

7. Select the version of the file you want to add and click Install to add the GSD file to the Hardware catalog.
8. Go to the View menu in the Hardware configuration window.
9. Check the Catalog option.

The Hardware catalog appears on the right side of the Hardware configuration window.

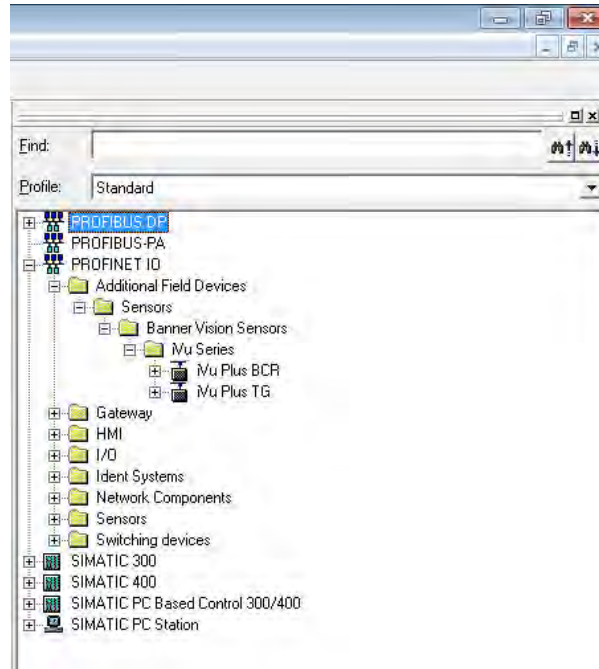

The location in the Hardware catalog is PROFINET IO > Additional Field Devices > Sensors > Banner Vision Sensors > iVu Series

Creating a PROFINET® Connection

Use these instructions to create a PROFINET Connection in Hardware configuration with the Siemens SIMATIC STEP 7 (v5.5) software.

1. Start Siemens SIMATIC Manager.
2. Select an existing project and open it.
3. Select the Station (PLC) from the Object Hierarchy list.

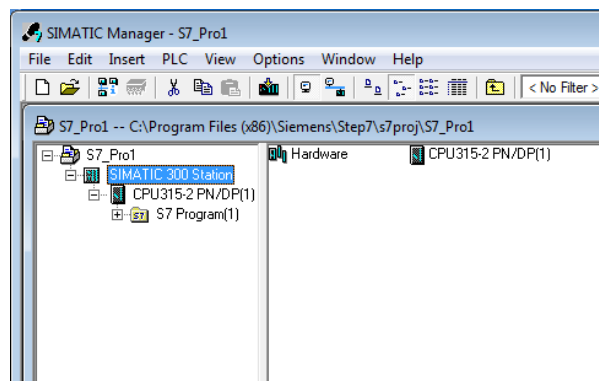

- Double-click on the Hardware icon in the Station level window to open the Hardware configuration window.

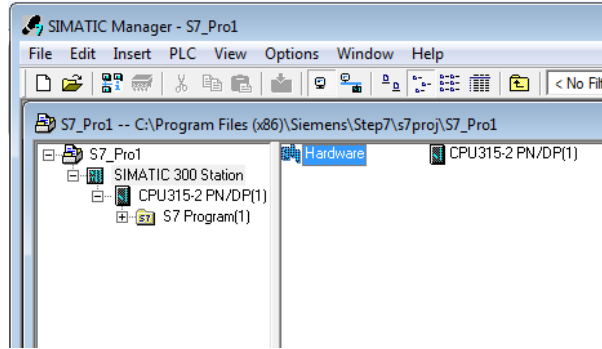

- Right-click on the PN-IO line in the CPU module of the Station window and select *Insert PROFINET IO System*.
- In the Parameters tab of the Ethernet interface properties window type in the IP Address and Subnet Mask of the PLC.
- Select the Ethernet subnetwork from the box at the bottom of the Ethernet interface properties window. If no suitable network is shown, click the New button to add one, then click OK.

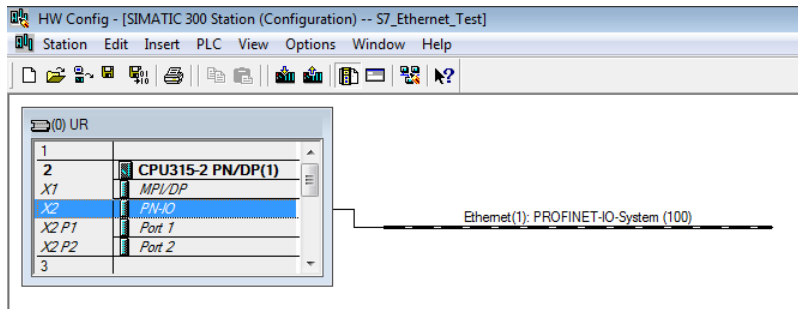

- Click iVu Plus BCR in the Hardware catalog and drag and drop onto the PROFINET IO system connection.

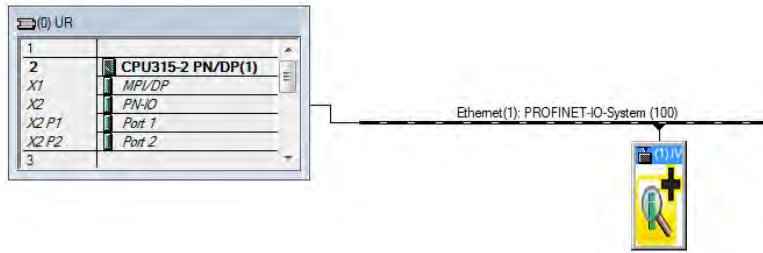

The device is connected to the system.

- Add modules and submodules.

Changing the Device IP Address

Use these instructions for the Siemens SIMATIC STEP 7 (v5.5) software.

- Start Siemens SIMATIC Manager.
- Select an existing project and open it.

3. Select the Station (PLC) from the Object Hierarchy list.

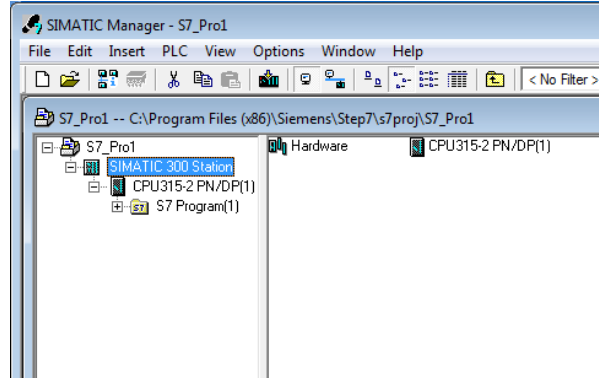

4. Double-click on the Hardware icon in the Station level window to open the Hardware configuration window.

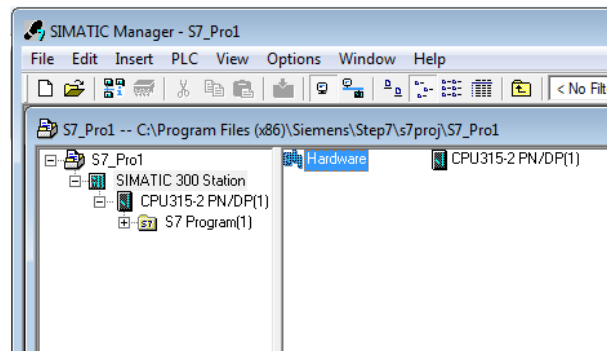

5. Select PLC > Ethernet > Edit Ethernet Node.

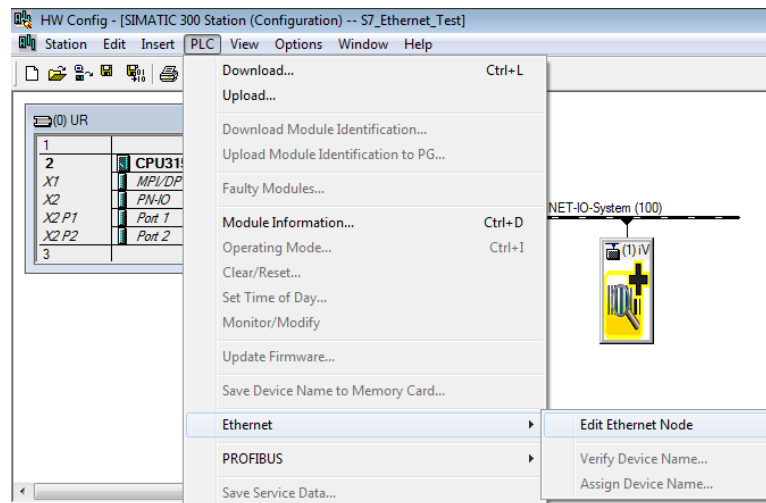

- Click Browse... under Nodes accessible online in the Edit Ethernet Node window.

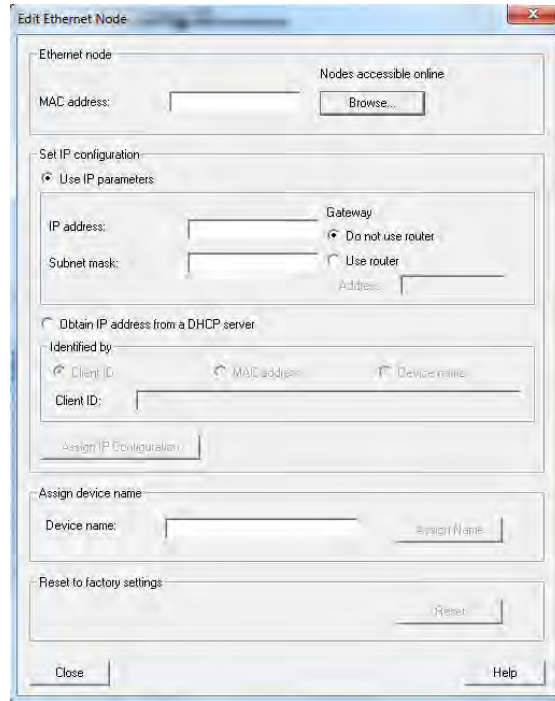

This starts a search for all PROFINET devices on the network and shows the found devices.

- Select the device to be modified.

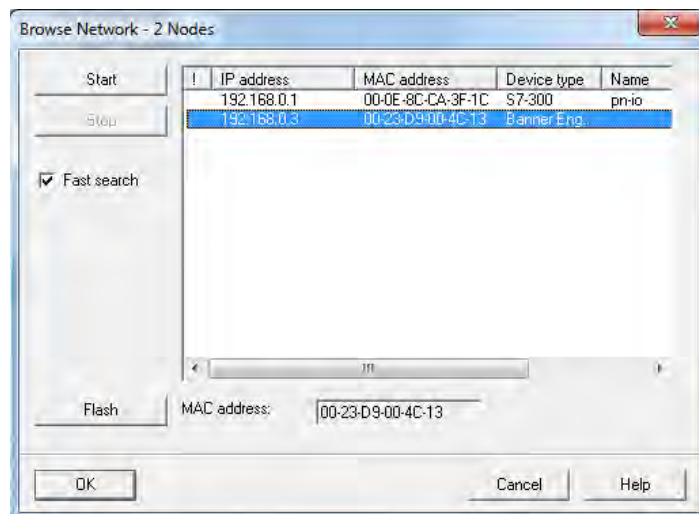

8. Click OK.

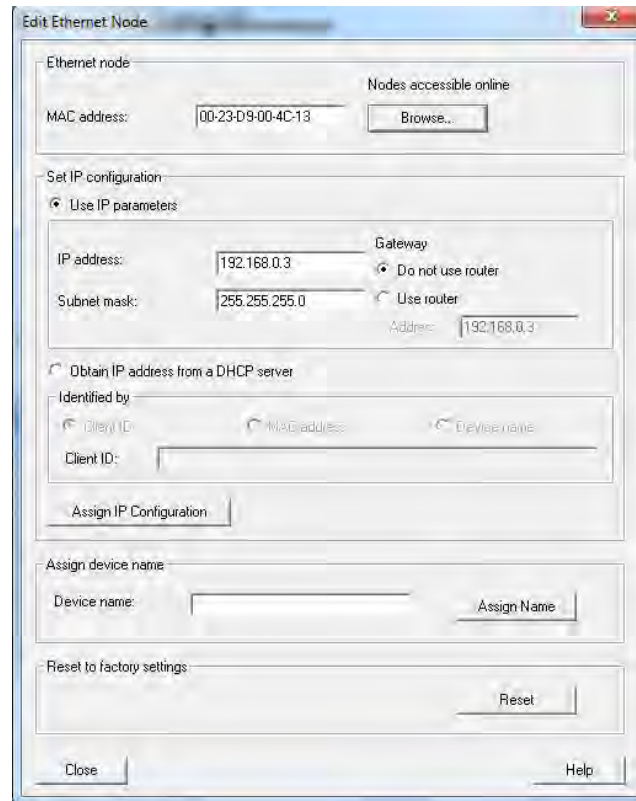

The Edit Ethernet Node window is updated.

9. Set the IP address to the desired value.
10. Click Assign IP Configuration at the bottom left of the Set IP configuration section. The parameters are transferred.
11. Click OK to acknowledge the message of a successful transfer.

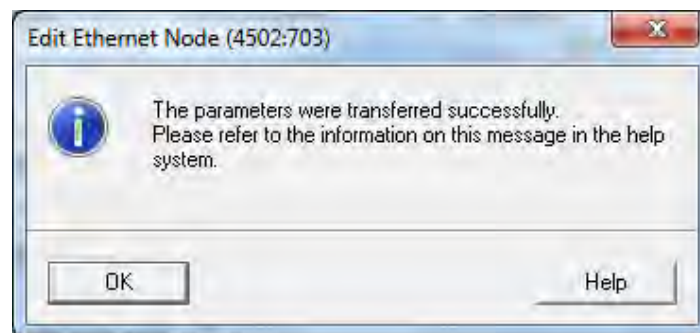

The IP address adjustment is complete.

Changing the Device Name

Use these instructions for the Siemens SIMATIC STEP 7 (v5.5) software.

1. Start Siemens SIMATIC Manager.
2. Select an existing project and open it.

3. Select a Station (PLC) from the Object Hierarchy list.

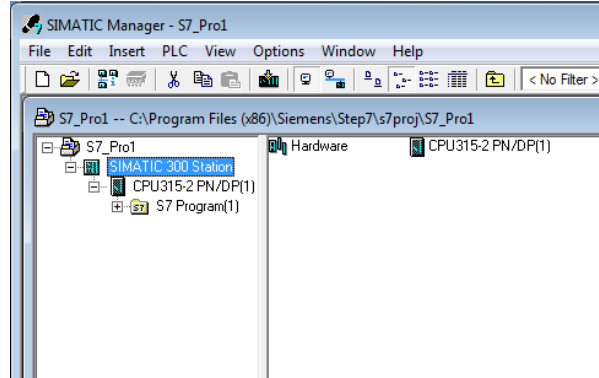

4. Double-click on the Hardware icon in the Station level window to open the Hardware configuration window.

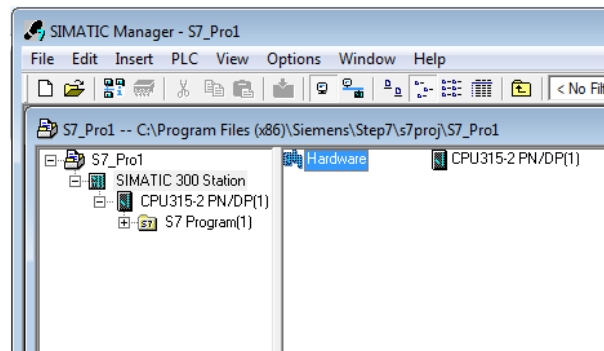

5. Select PLC > Ethernet > Edit Ethernet Node.

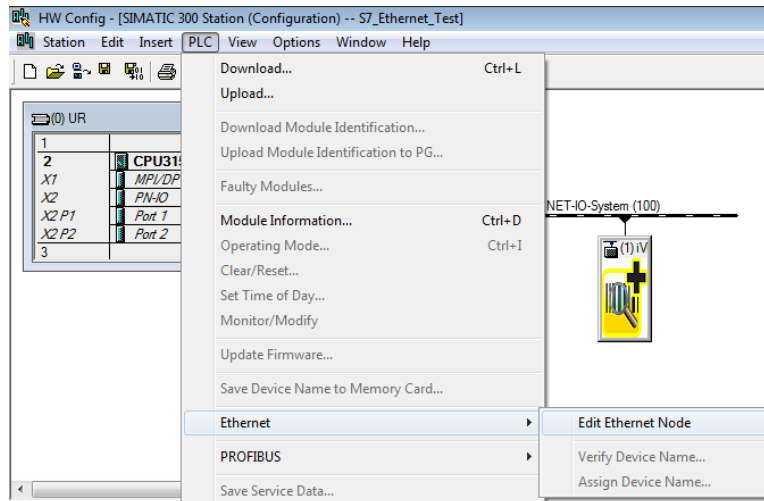

- Click Browse... under Nodes accessible online in the Edit Ethernet Node window.

Edit Ethernet Node

Ethernet node

MAC address: **Nodes accessible online**
Browse...

Set IP configuration

Use IP parameters

IP address: Gateway
Subnet mask: Do not use router
 Use router
Address:

Obtain IP address from a DHCP server

Identified by

Client ID MAC address Device name

Client ID:

Assign IP Configuration

Assign device name

Device name: Assign Name

Reset to factory settings

Reset

Close Help

This starts a search for all PROFINET® devices on the network and shows the found devices.

- Select the device to be modified.

Browse Network - 2 Nodes

Start

Stop

Fast search

| IP address | MAC address | Device type | Name |
|-------------|-------------------|-------------|-------|
| 192.168.0.1 | 00-0E-8C-CA-3F-1C | S7-300 | pr-io |
| 192.168.0.3 | 00-23-D9-00-4C-13 | Banner Eng. | |

Flash

MAC address:

OK Cancel Help

8. Click OK.

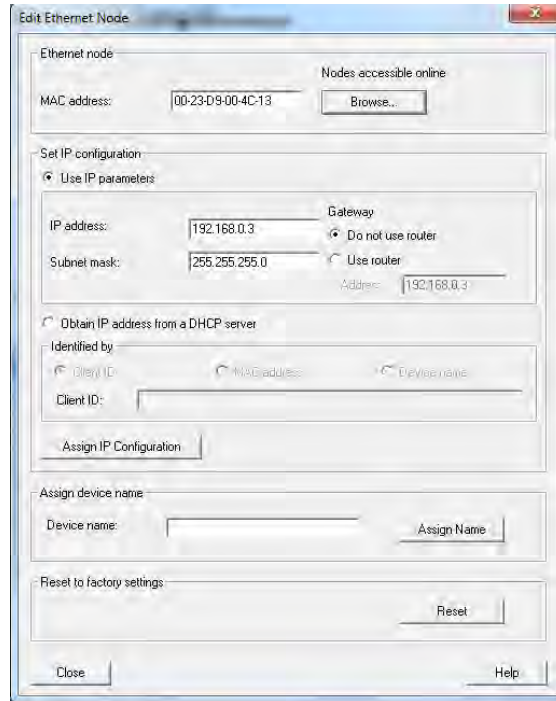

The Edit Ethernet Node window is updated.

- 9. Enter a name with lower case letters in the Device name field.
- 10. Click Assign Name.

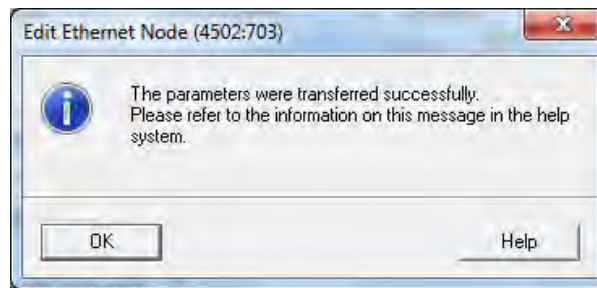

The Device name is updated. If a failed update message is returned, the new name did not meet the naming requirements. Reference the Siemens PLC naming convention.

7.8 Sample Timing Diagram

X, Y, Z: Represent snapshot in time

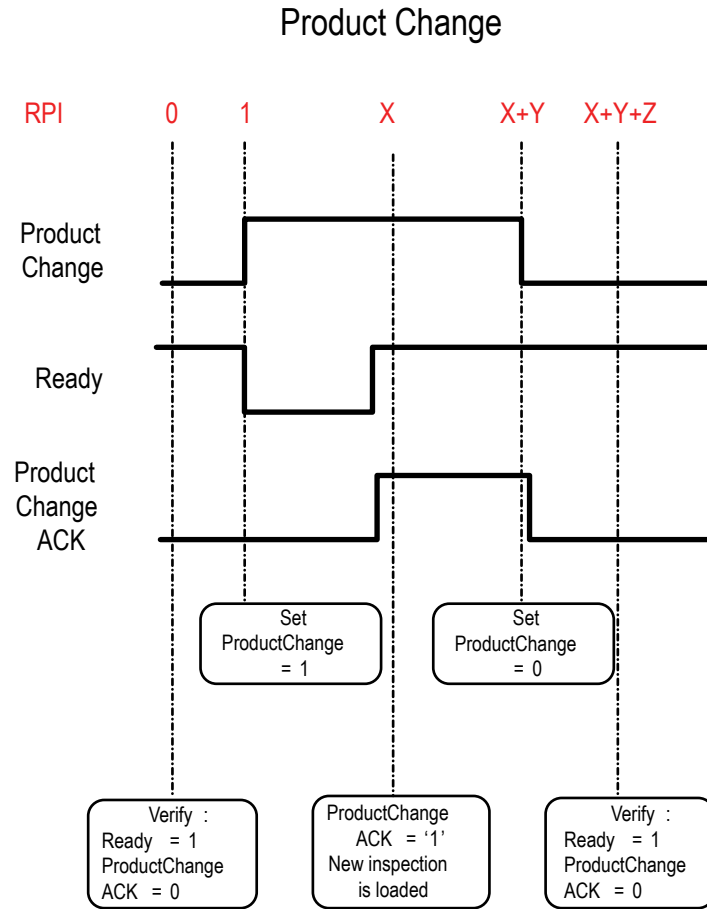

Teach Latch

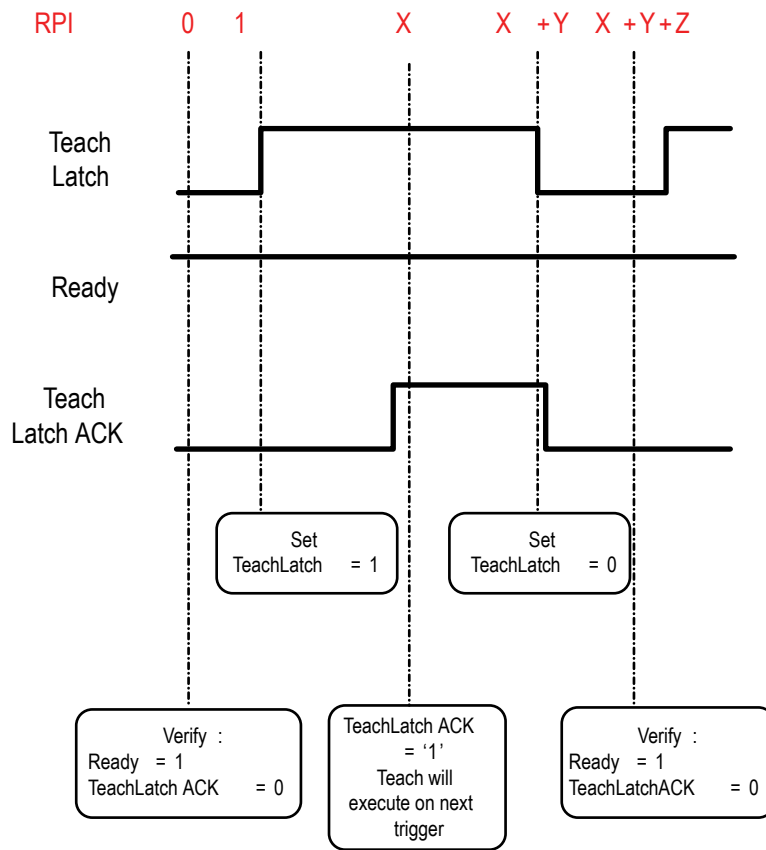

Trigger

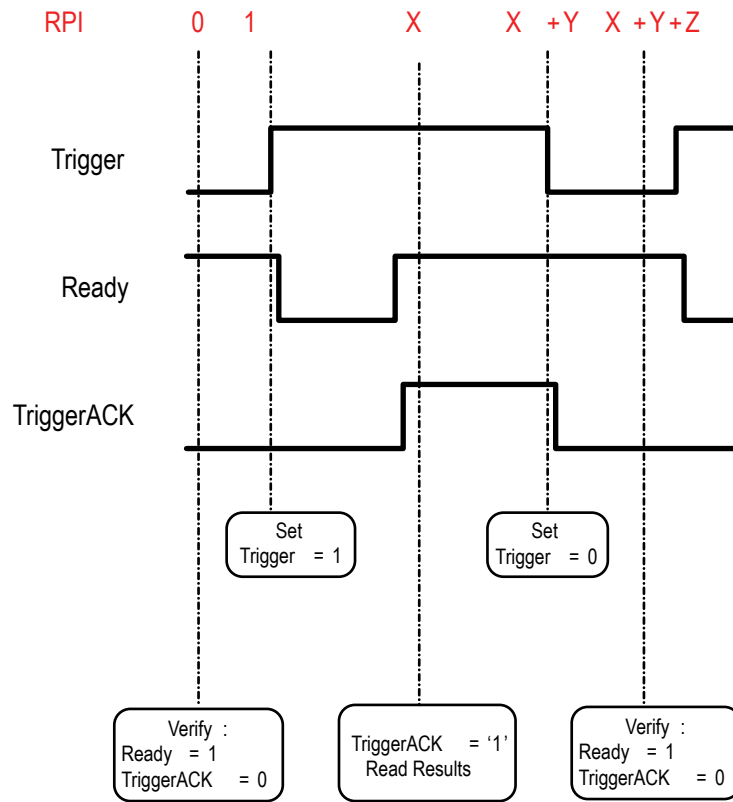

Gated Trigger

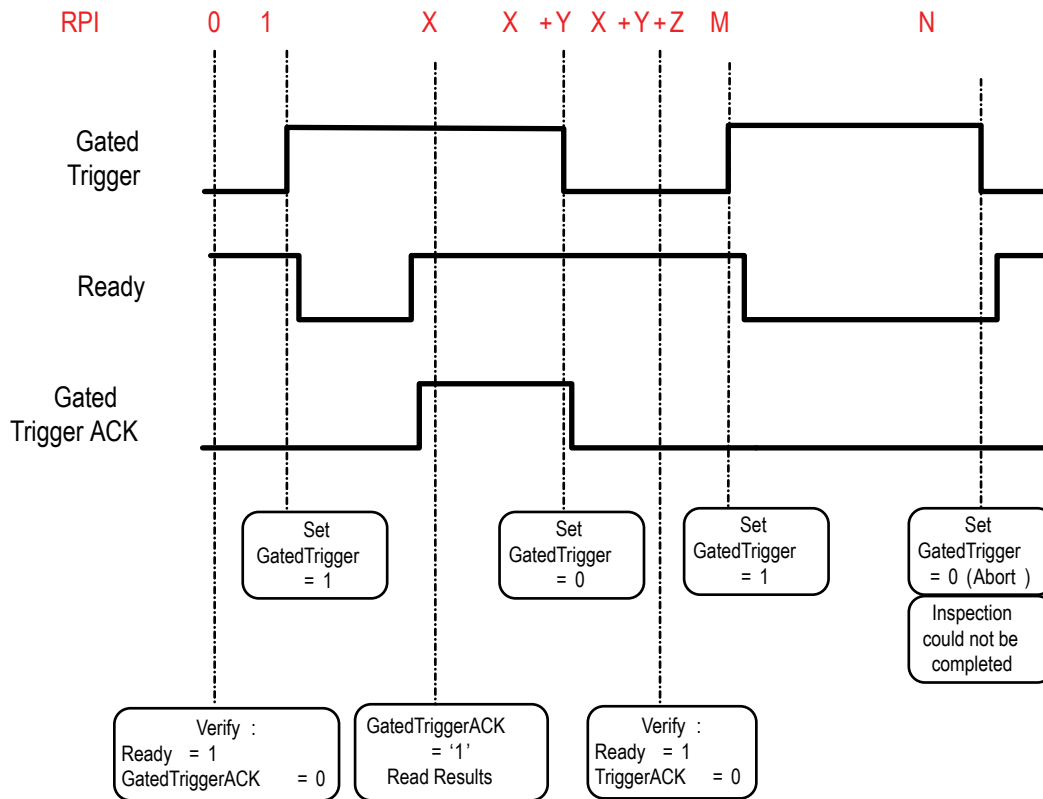

7.9 Command Channel Command Status Register

The command status is a verification of the command type.

| Command Status | Value (16-bit integer) |
|----------------|------------------------|
| Unknown | 0 |
| Read | 1 |
| Write | 2 |
| Execute | 3 |

7.10 Diagnostic Guide

iVu Plus sensors provide several methods to help diagnose communication issues when using Ethernet communications.

7.10.1 Ethernet Diagnostics

To verify Ethernet connectivity, follow these steps:

1. Verify that all the cables are connected and properly seated.

- Examine the small orange Ethernet link light located on the top of camera body, between the Pass/Fail and System Status LEDs. The light should be either on or blinking.
- Go to the System > Logs > System Log page, and verify that the log entry indicates that the Ethernet link is up:

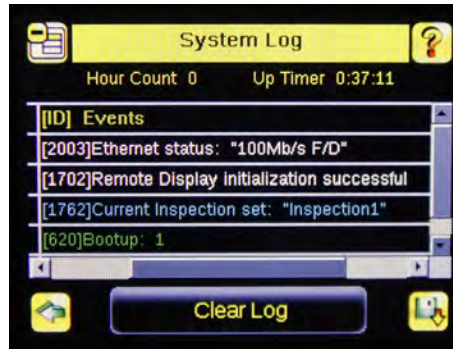

- Go to the System > Communications > Ethernet I/O page, and press on the Status button. Verify that the Ethernet Link Status is "Connected", and that the link parameters, such as baud rate and duplex are as expected. For example:

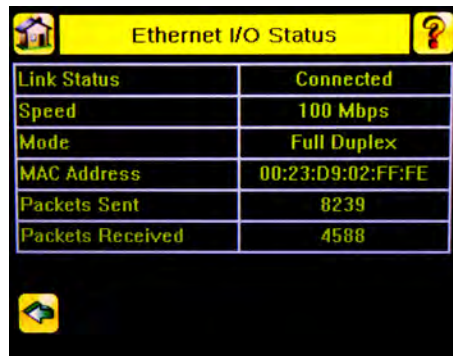

- If the Link Status indicates that there is no link, please inspect the wiring, and verify that your Ethernet switch is powered up.
- If the link parameters are not as expected (wrong baud rate or duplex) try the following:
 - Log into your managed switch and verify that the port to which iVu camera is connected is correctly configured. Alternatively, consult with your IT person to perform this verification.
 - Verify that your cable is of the right type, and is properly connected to the switch and to the camera.

7.10.2 Networking and TCP/IP Diagnostics

To verify networking and TCP/IP connectivity, follow these steps:

- Verify that the Ethernet link has been established.
- Visit the System > Communications > Ethernet I/O page, and examine the sensor IP address, subnet mask, and the Gateway address:

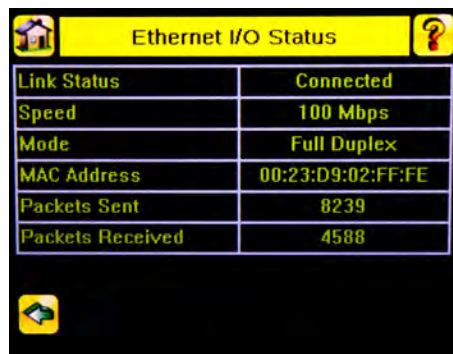

- Verify with your IT person that these settings are correct.
 - If necessary, make the required modifications and reboot the sensor

- Press the Status button on the same page, and go to the Ethernet I/O Status page:

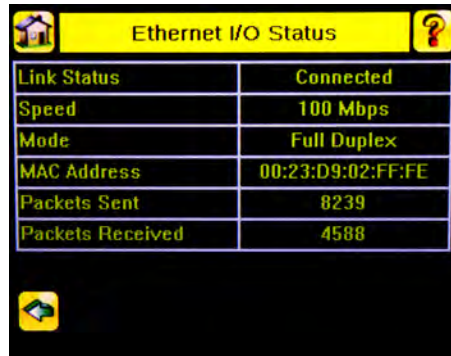

- On the PC attached to your LAN, open the Command window. To do this, press Start > Run, and then type in `cmd` and press the OK button.
- A command window will display:

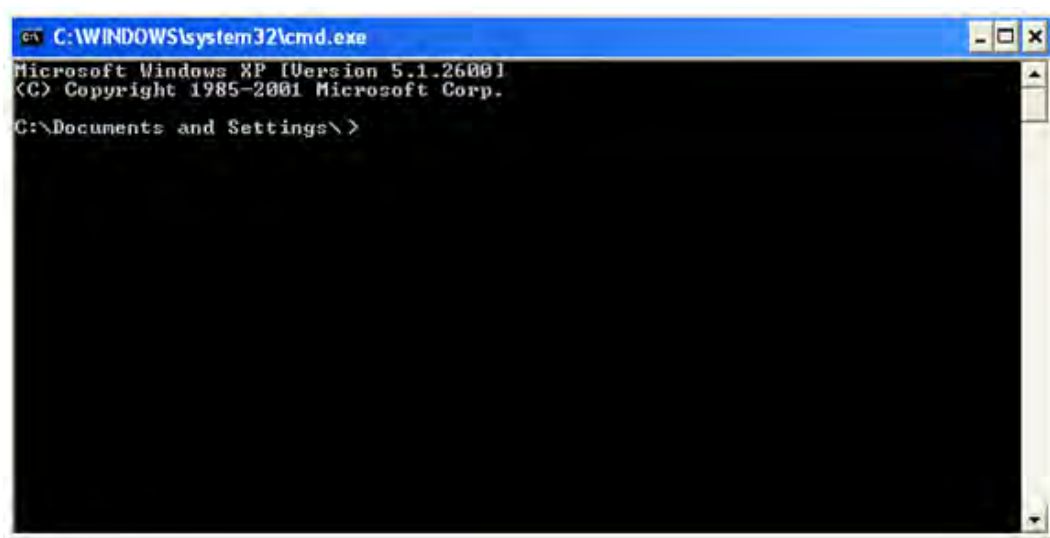

- Type in a ping command, specifying the sensor IP address as an argument. You should see a series of responses from the camera:

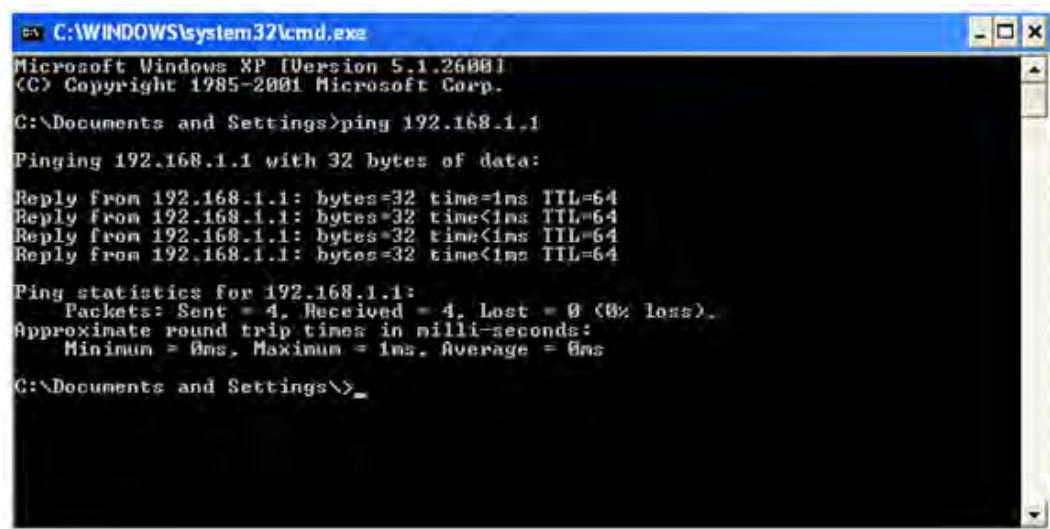

8. You should also see the Packets Received and Packets Sent count on the Ethernet I/O Status page in the camera increment by at least 4.
9. If the output of the ping command shows request timeouts, try the following:
 - Verify that the camera is located on the correct subnet, has the correct IP address, and is connected to the correct switch or router.
 - If you are running several overlapping subnets, you may want to consult your IT person to ensure that the routing for the network is configured correctly.
 - If you are trying to access the camera through a gateway or a VPN router, please verify that these devices are configured such that they allow traffic from iVu camera to reach the destination device.

7.10.3 Industrial Protocols Troubleshooting

Modbus/TCP Protocol

Modbus/TCP protocol relies on the fundamental TCP/IP connectivity to establish connections and transport data. Once you have verified Networking and TCP/IP connectivity, you should have little or no problems establishing a Modbus/TCP connection.

iVu supports one Modbus/TCP connection from a single client, and will reject additional connection requests.

Prior to attempting to establish the Modbus/TCP connection, you will have to configure your device, and teach it about the iVu sensor. You will have to tell it the IP address of the iVu sensor that you have previously configured. Configurations steps vary for each device, so you will have to consult the appropriate manual for these steps.

If your device has user-configurable Modbus/TCP port, please verify that it is set to port number 502. iVu will not accept connections on any other port.

Once you have established a Modbus/TCP connection, you can verify that iVu has accepted it by going to the System > Communications > Industrial Ethernet > Status page, and viewing the connection status:

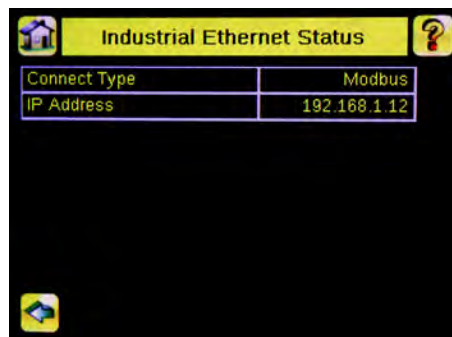

If you experience issues accessing data, please consult the relevant sections of the manual for the Modbus/TCP register maps supported by the sensor, and consult the Industrial Protocols Log. The log, when configured to Detailed Logging mode, provides record of individual register access sequence, and records any errors:

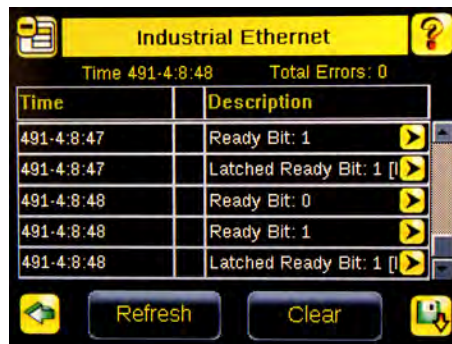

EtherNet/IP and PCCC Protocols

EtherNet/IP and PCCC protocols rely on CIP protocol to establish communications and exchange data. CIP protocol, in turn, utilizes TCP/IP.

In addition, EtherNet/IP implements I/O messaging. I/O messaging allows two devices, iVu sensor and the PLC, to continuously synchronize data sets between each other. These data sets are called Input and Output Assemblies. iVu device consumes PLC output assemblies, and produces PLC input assemblies. This exchange occurs continuously, and the rate specified by the RPI (requested Packet Interval) value.

I/O messaging is based on UDP/IP, and utilizes Multicast addressing when sending PLC input assemblies. It is the default mode of operation for I/O messages in PLCs. Newer PLCs also support Unicast (direct) addressing for PLC input assemblies, but need to be specially configured.

Because I/O messaging uses IDP/IP and Multicast, it requires special, managed switches, and customized switch configuration. Managed switches, when properly configured, prevent multicast devices from flooding the network with data. Please consult your IT person to make sure that you have the correct switch type, and that these switches have IGMP snooping enabled, to allow them to manage multicast groups.

In addition, some switches with built-in firewalls block UDP traffic by default. If this is the case, and if the path between your devices involves several switches or routers, it is possible that some of them might block the UDP traffic necessary for I/O messages. Please consult your IT person to verify that your network is configured correctly. Also consult Rockwell publications ENET-AP001D-EN-P, *EtherNet/IP Performance*, and ENET-SO001A-EN-E, *EtherNet Design Considerations for Control System Networks* for further information on how to configure your EtherNet network for EtherNet/IP.

Establishing CIP and EtherNet/IP I/O communications is a complicated process. There are a number of steps during which an error can occur. Industrial Protocols log contains a detail description of the communications process, and should be consulted if any errors are suspected.

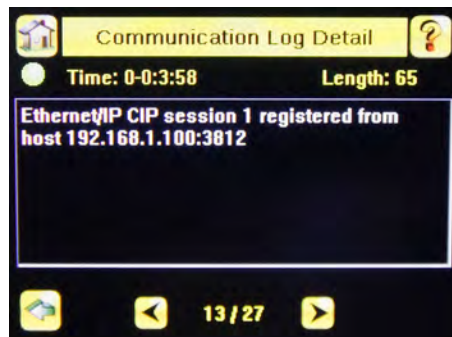

A great level of detail is also provided in the log when the I/O connection is established:

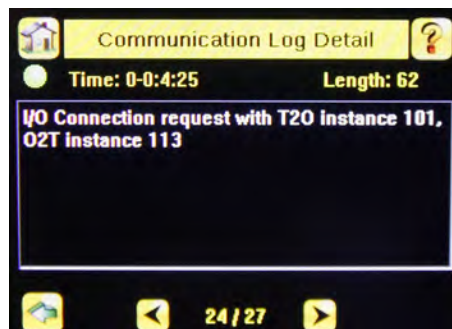
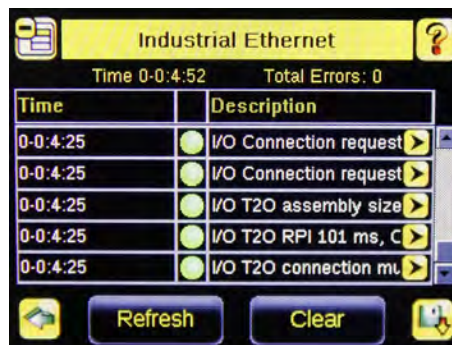

After the CIP and I/O connections are established, the Industrial Protocols Status page will show the details of the connection:

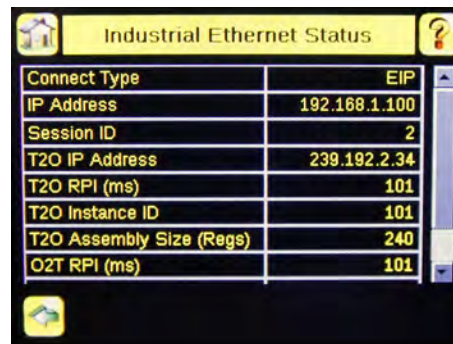

| Industrial Ethernet Status | |
|----------------------------|---------------|
| Connect Type | EIP |
| IP Address | 192.168.1.100 |
| Session ID | 2 |
| T2O IP Address | 239.192.2.34 |
| T2O RPI (ms) | 101 |
| T2O Instance ID | 101 |
| T2O Assembly Size (Regs) | 240 |
| O2T RPI (ms) | 101 |

Most of the errors in establishing the CIP and I/O connections have to do with specifying the proper Input and Output assembly IDs and sizes. Please refer to the appropriate sections of this manual for this information.

PROFINET

Discovering Sensors

The Siemens TIA Portal (v13) software discovery and configuration protocols are used to discover sensors on a network.

1. Start the Siemens TIA Portal (v13) software.
2. Click Open an existing project.
3. Select a project and open it.
4. Click Devices & networks when the project has been uploaded.
5. Click Configure networks.
6. Click the Accessible devices icon.



The Accessible devices window opens.

7. Select an interface connection in the Type of the PG/PC interface drop-down menu.
8. Select an interface connection in the PG/PC interface drop-down menu.

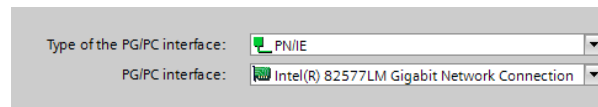

The PC scans the network for PROFINET® devices. If the device you are looking for is not present, check the cabling.

Example of Scanning Results

Under Online status information, the scan shows that three devices were found.

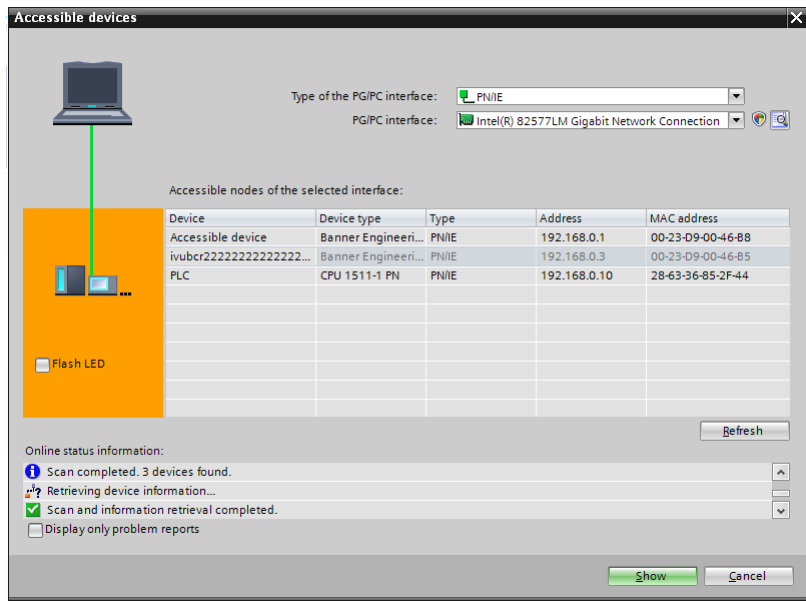

Accessing the Sensor's Communication Logs

PROFINET® communication activity is recorded in the iVu Plus sensor's communication logs. Use these instructions to access the sensor's communication logs via the sensor's touch screen.

1. Click on the Wrench button on the iVu Plus Home screen.

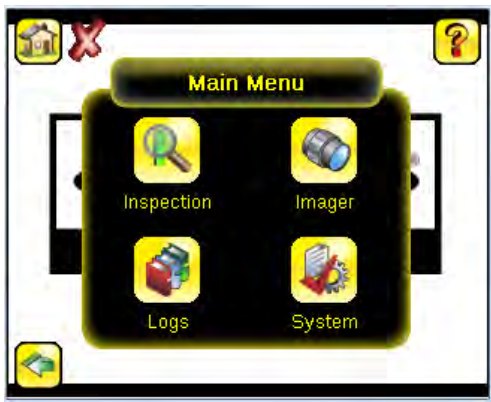
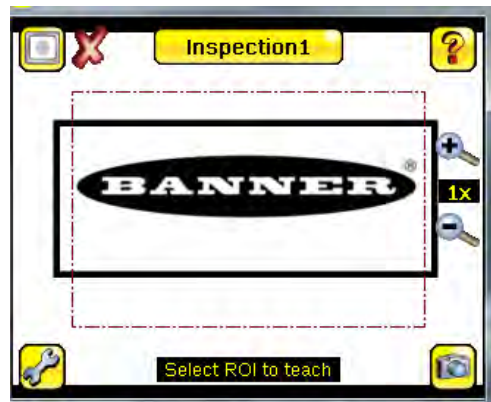

The Main Menu window displays.

2. Click on Logs.

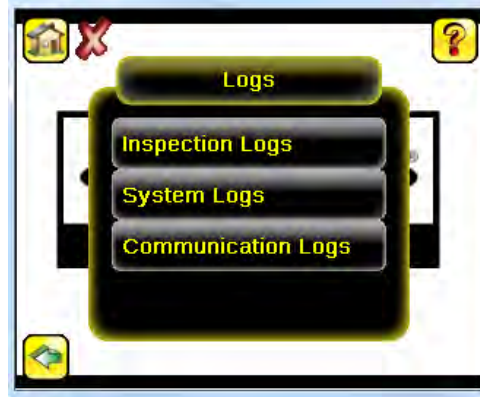

3. Click on Communication Logs.

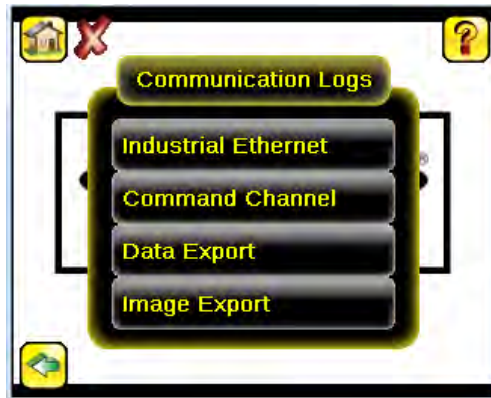

4. Click on Industrial Ethernet.

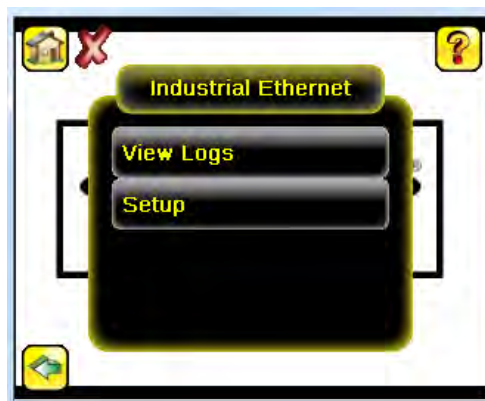

5. Click on View Logs.

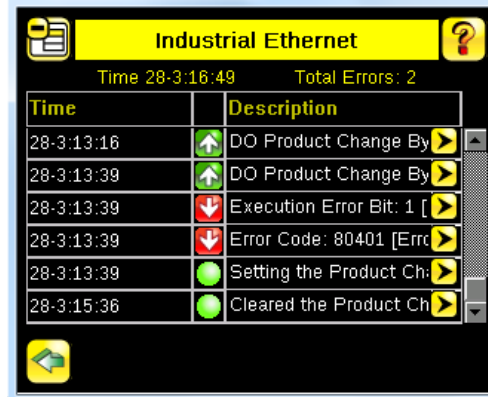

The screenshot shows a software interface titled "Industrial Ethernet" with a yellow header bar. Below the header, it displays "Time 28-3:16:49" and "Total Errors: 2". A table lists several log entries with columns for "Time" and "Description". Each entry includes a small icon representing the status of the communication (green for success, red for error). A yellow double-headed arrow icon is visible at the bottom left of the interface.

| Time | Description |
|------------|------------------------|
| 28-3:13:16 | DO Product Change By |
| 28-3:13:39 | DO Product Change By |
| 28-3:13:39 | Execution Error Bit: 1 |
| 28-3:13:39 | Error Code: 80401 [Err |
| 28-3:13:39 | Setting the Product Ch |
| 28-3:15:36 | Cleared the Product Ch |



NOTE: Green communication log icons mean flawless communication. Red communication icons mean communication errors.

- Click on the Arrow button on any log entry in the communication log to access the Communication Log Detail window.



NOTE: An expanded description of the communication supports better diagnostics.

The figure displays five screenshots of the 'Communication Log Detail' window, arranged in three rows. Each window shows a log entry with a time, length, and a description of the event.

- Top Left:** Time: 28-3:13:39, Length: 65. Error Code: 80401 [Error=80401_PRODUCT_CHANGE_INVALID_INSPECTION].
- Top Right:** Time: 28-3:13:39, Length: 43. Setting the Product Change diagnostic alarm.
- Middle Left:** Time: 28-3:13:16, Length: 27. DO Product Change By Number.
- Middle Right:** Time: 28-3:13:39, Length: 58. Execution Error Bit: 1 [Error=00520_IE_COIL_ACTION_FAILED].
- Bottom:** Time: 28-3:15:36, Length: 43. Cleared the Product Change diagnostic alarm.

Each window also features a navigation bar at the bottom with a home icon, a left arrow, a page indicator (e.g., 742 / 744), and a right arrow.

Diagnosing Errors

The Siemens TIA Portal (v13) software includes numerous diagnostic tools. When a computer is connected to the controller (PLC), diagnostic information is available. The controller (PLC) generates a message that is displayed in the Diagnostics window. A flashing red light on the CPU module of the controller (PLC) indicates an error.

1. Click on the text in the Details column to request detailed information about the device that caused the error.

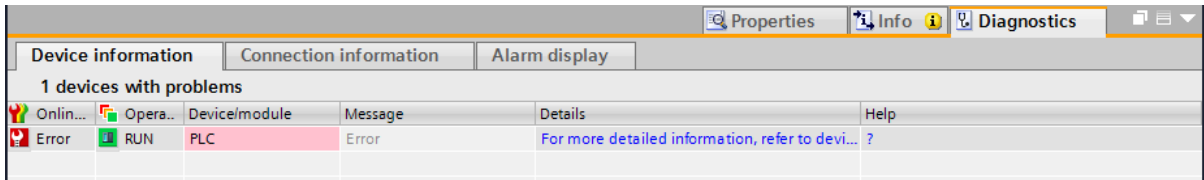

All system and device messages are displayed in the Diagnostics buffer window under Events and Details on event.

2. Select a message in the table, Display CPU Time Stamps in PG/PC local time.

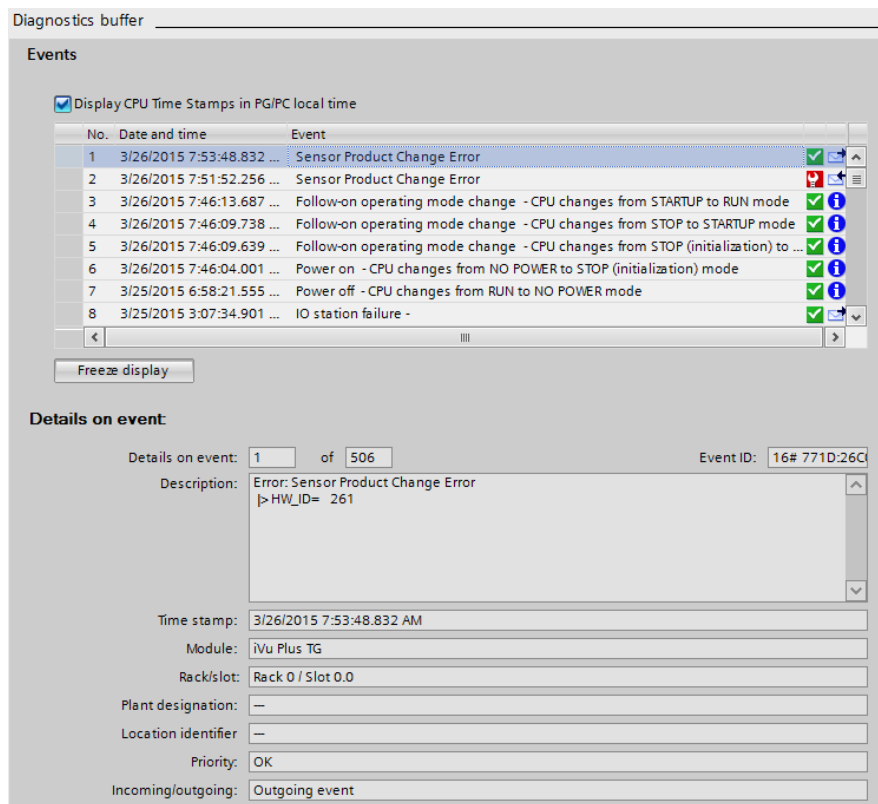

The respective information is displayed in the Description field under Details on event.

3. Read the message to learn about the error and resolve it. When the error is resolved, the icon that corresponds to the displayed message is green.

7.11 Additional Information

7.11.1 iVu Command Channel Commands (iVu Command Channel over Industrial EtherNet)

This section describes how to use the iVu Command Channel over Industrial EtherNet. Please see the iVu Plus Communications User's Guide for more information on the iVu Command Channel protocol. The following commands need to be executed using the Command ID register and the Command Input bit/Input Coil bit.

| Command | Command ID | | | Description | Data Type |
|------------------------|------------|-----|-------|--|------------|
| | Do | Set | Get | | |
| Trigger | | | | | |
| Trigger Mode | | 1 | 10001 | The sensor's triggering mode. This value must match the modes supported by the sensor | Int16 |
| Product Change | | | | | |
| Product Change By Name | 21 | | | This command forces the sensor to switch to the specified inspection. The sensor does not transmit a response until the sensor has completed the action. Inspections results immediately after a product change will be invalid until a new trigger is received. | Byte Array |
| Imager | | | | | |
| Gain | | 51 | 10051 | The sensor's value used to electronically brighten all image pixels | Int32 |
| Exposure | | 52 | 10052 | The sensor's value used to control the amount of time the imager is allowed to gather light for the image. | Int32 |
| Status | | | | | |
| Clear System Error | 81 | | | This command clears the system error LED and resets the internal system error flag to false. | N/A |
| System | | | | | |
| Reboot Sensor | 101 | | | This command reboots the sensor. If sensor configuration data is being currently being saved, this command will block until that operation completes | N/A |
| Save Configuration | 102 | | | This command saves all modified inspection and configuration parameters. This command blocks until all values have been persisted | N/A |
| Info | | | | | |
| Sensor Name | | | 10151 | Sensor user assignable name. | Byte Array |
| Model Number | | | 10152 | Sensor model number | Byte Array |
| Serial Number | | | 10153 | Sensor serial number | Byte Array |
| Firmware Version | | | 10154 | Sensor firmware (software) version | Byte Array |
| Hour Counter | | | 10155 | The total number of hours the sensor has been energized. | Byte Array |
| History | | | | | |
| Clear History | 301 | | | This command clears all history fields for the active inspection. History values include pass count, fail count, execution times and sensor specific history values. | N/A |
| Inspection | | | | | |
| Inspection Name | | | 10501 | The name of the active inspection. | Byte Array |
| BCR inputs | | | | | |

| Command | Command ID | | | Description | Data Type |
|----------------|------------|-----|-------|---|------------|
| | Do | Set | Get | | |
| Compare String | | | 11001 | The Barcode inspection compare data string. This string must start and end with the double quote character | Byte Array |
| Compare Mask | | | 11002 | The Barcode inspection compare string mask in binary format; that is, masked characters are indicated by a "1" and unmasked characters are "0." Note that the mask character string must match the length of the compare string | Byte Array |

| Trigger Mode | 1000 | Description |
|--------------------|------|---|
| External | 1 | Inspections will be initiated via the electrical trigger wire |
| Internal | 2 | Inspections will run continuously at the specified period (electrical trigger inputs are ignored) |
| FreeRun | 3 | Inspections will run continuously (electrical trigger inputs are ignored) |
| ExternalGated | 4 | Gated barcode inspection will be started and/or aborted via the electrical trigger wire |
| ContinuousScan | 5 | Inspections will run continuously (electrical trigger inputs are ignored) |
| IndustrialEtherNet | 10 | Inspections will only be triggered by Industrial Ethernet coils and commands. |
| Command | 20 | Inspections will only be triggered by the Command Channel trigger commands. |

Error Codes

The iVu Plus sensor provides error codes in cases when commands failed to execute successfully. If such an error occurs, the Execution Error flag is set in the Output Bits/Status Register. When this bit is set, read the Error Code register to know the reason of failure. Below is the list of error codes:

| Numeric ID | Text ID | Description |
|------------|--------------------------------|---|
| 0 | SUCCESS | Command processed successfully. |
| 500 | IE_TRIGGER_MODE_EXPECTED | The Trigger Mode must be set to 'Industrial Ethernet' to perform this operation. |
| 510 | IE_COMMAND_NOT_FOUND | The numeric Command ID specified was not found. |
| 520 | IE_COIL_ACTION_FAILED | The coil action resulted in a failure. |
| 521 | IE_COIL_ALREADY_BUSY | The coil was asserted before previous execution completed. |
| 522 | IE_COIL_NOT_FINISHED | The coil was de-asserted prior to execution completing. |
| 523 | IE_COIL_ANOTHER_ACTION_PENDING | The coil was asserted prior to another coil execution completing. |
| 524 | IE_COIL_MULTIPLES_DETECTED | Multiple coils were asserted simultaneously. |
| 525 | IE_COIL_ACK_INHIBITED | The coil action's output ACK was inhibited because the input coil was no longer set. |
| 00000 | SUCCESS | Command processed successfully |
| 10000 | EMPTY_FRAME_RECEIVED | Indicates that the request was empty. The command channel requires a command, any arguments, and an end-of-frame delimiter. |
| 10001 | COMMAND_NOT_RECOGNIZED | The command specified is not recognized |
| 10100 | GROUP_MISSING | A Group ID must be specified immediately after the command |
| 10101 | GROUP_NOT_FOUND | The specified Group ID is invalid / unknown |
| 10102 | GROUP_ITEM_MISSING | A Group Item ID must be specified immediately after the Group ID |
| 10103 | GROUP_ITEM_NOT_FOUND | The specified Group Item ID is invalid / unknown |
| 10152 | NOT_READABLE | Attempt to get a value that is not readable |

| Numeric ID | Text ID | Description |
|------------|-----------------------------------|--|
| 10153 | NOT_WRITEABLE | Attempt to set a value that is not writeable |
| 10250 | NOT_A_METHOD | Method ID specified is not a method |
| 10251 | WRONG_ARGUMENT_COUNT | Total method arguments specified do not match method |
| 10252 | COMMAND_NOT_FINISHED | Attempt to issue command when a previous command has not finished |
| 10300 | INVALID_ARGUMENT_TYPE | Item ID specified must be a item (not a group or method) |
| 10301 | DATA_VALUE_MISSING | Command missing item's data value |
| 10340 | MINIMUM_VALUE_EXCEEDED | New item value is below the minimum |
| 10341 | MAXIMUM_VALUE_EXCEEDED | New items value is above the maximum |
| 10350 | ARGUMENTS_DETECTED | Get command received with unneeded arguments |
| 10351 | INVALID_ARGUMENT_TYPE | Item ID specified must be a item (not a group or method) |
| 10500 | DATA_SET_EMPTY | Data export operation returned no results. |
| 10900 | SENSOR_NOT_READY | Command specified requires sensor to be in the READY state. |
| 10920 | SENSOR_TYPE_NOT_ACTIVE | Command specified belongs to a different sensor type. |
| 10950 | DEVICE_TYPE_INVALID | Command not supported on this device type. |
| 15000 | VALUE_INVALID | Text value is invalid / unknown |
| 15050 | VALUE_INVALID | Text value is invalid - expecting True or False |
| 15100 | STRING_TOO_LONG | String value specified exceeds maximum allowable length |
| 20002 | COMPARE_DATA_DISABLED | Operation requires Barcode compare to be enabled |
| 20003 | COMPARE_MASK_INVALID | Compare mask invalid. Expecting string of 1's and 0's with length equal to compare data string |
| 20004 | NUMBER_TO_FIND_NOT_ONE | Barcode number to find must be set to one for this operation. |
| 20005 | COMPARE_MASK_DISABLED | Operation requires Barcode compare mask to be enabled. |
| 20200 | NO_AREAS_FOUND | Attempt to obtain value when no areas were found. |
| 20600 | NO_MATCHES_FOUND | Attempt to obtain value when no matches were found. |
| 20800 | NO_MATCHES_FOUND | Attempt to obtain value when no sort patterns were found. |
| 80000 | REMOTE_DISPLAY_NOT_CONNECTED | Remote Display must be connected to obtain this value |
| 80001 | REMOTE_DISPLAY_NOT_SUPPORTED | This sensor does not have Remote Display capability |
| 80100 | COMMAND_MODE_EXPECTED | The Trigger Mode must be set to "Command" perform this operation |
| 80101 | COMMAND_TIMED_OUT | The command timed out before finishing |
| 80102 | TRIGGER_REQUIRED | Access to the specified data requires a triggered inspection |
| 80150 | COMMAND_TIMED_OUT | The command timed out before finishing |
| 80200 | SYSTEM_ERROR_NOT_ACTIVE | The System Error must be active to execute this command |
| 80300 | TEACH_SENSOR_TYPE_INVALID | Teach requires Match Sensor type. |
| 80350 | MULTIPLE_INSPECTIONS_DISABLED | Requires multiple inspections to be enabled |
| 80351 | MULTIPLE_INSPECTIONS_EMPTY | No inspections are available in multiple inspection mode. |
| 80400 | PRODUCT_CHANGE_WHEN_NOT_READY | Sensor must be in the READY state to perform a product change. |
| 80401 | PRODUCT_CHANGE_INVALID_INSPECTION | Attempt to product change to a unknown or invalid inspection. |
| 80402 | PRODUCT_CHANGE_TIMEOUT | The Product Change operation timed out. |
| 80403 | PRODUCT_CHANGE_TO_SAME_INSPECTION | Attempt to product change to the same inspection. |
| 80404 | SENSOR_NAME_NOT_FOUND | Attempt to use a command without a sensor name in a multi-sensor inspection |

Examples of Operation

The following examples show how the iVu Command Channel can be utilized via the Industrial Ethernet connection.

Clear System Error

1. Write the number 81 as a 16-bit integer into the Command ID register.
2. Toggle the Command bit from 0 to 1 (bit 15 in the Input Bits/Input Coil Bits register).
3. Wait for the Command ACK flag to go from 0 to 1 (bit 15 in the Input Bits ACK/Input Coil Bits ACK register).
4. Verify that the Execution Error flag is not set (i.e. value should be 0). This is bit 15 in the Output Bits/Status Coil Bits register. If the value is 1, read the Error Code register for more information.
5. Task Complete. Toggle the Command bit back to 0 (bit 15 in the Input Bits/Input Coil Bits register).

Get/Set Trigger Mode

Get the current Trigger Mode from the iVu Plus.

1. Write the number 10001 as a 16-bit integer into the Command ID register.
2. Toggle the Command bit from 0 to 1 (bit 15 in the Input Bits/Input Coil Bits register).
3. Wait for the Command ACK flag to go from 0 to 1 (bit 15 in the Input Bits ACK/Input Coil Bits ACK register).
4. Verify that the Execution Error flag is not set (i.e. value should be 0). This is bit 15 in the Output Bits/Status Coil Bits register. If the value is 1, read the Error Code register for more information.
5. Task Complete. Toggle the Command bit back to 0 (bit 15 in the Input Bits/Input Coil Bits register). Read the current Trigger Mode value in the Command Response Int16 register.

| iVu model | Trigger Mode | Int16 value |
|-----------|--------------------------|-------------|
| TG, BCR | External | 1 |
| TG | Internal | 2 |
| TG | Free Run | 3 |
| TG, BCR | Industrial EtherNet Only | 10 |
| TG, BCR | Command | 20 |
| BCR | Continuous Scan | 5 |
| BCR | External Gated | 4 |

Set the desired Trigger Mode for the iVu Plus:

1. Write the number 1 as a 16-bit integer into the Command ID register.
2. Write the desired Trigger Mode's Int16 value from the above table into the Command Parameter Int16 register.
3. Toggle the Command bit from 0 to 1 (bit 15 in the Input Bits/Input Coil Bits register).
4. Wait for the Command ACK flag to go from 0 to 1 (bit 15 in the Input Bits ACK/Input Coil Bits ACK register).
5. Verify that the Execution Error flag is not set (i.e. value should be 0). This is bit 15 in the Output Bits/Status Coil Bits register. If the value is 1, read the Error Code register for more information.
6. Task Complete. Toggle the Command bit back to 0 (bit 15 in the Input Bits/Input Coil Bits register).

Set New Barcode Compare String

This procedure assumes that the Data Compare feature is enabled (found in the Inspection menu for the iVu Plus BCR).

1. Write the number 11001 as a 16-bit integer into the Command ID register.
2. Fill in the Command Parameters String registers with the ASCII data to be used as the new barcode compare string.
3. Write a 32-bit integer value equal to the number of ASCII characters present in the new barcode compare string data into the Command Parameter String Length register.
4. Toggle the Command bit from 0 to 1 (bit 15 in the Input Bits/Input Coil Bits register).
5. Wait for the Command ACK flag to go from 0 to 1 (bit 15 in the Input Bits ACK/Input Coil Bits ACK register).
6. Verify that the Execution Error flag is not set (i.e. value should be 0). This is bit 15 in the Output Bits/Status Coil Bits register. If the value is 1, read the Error Code register for more information.
7. Task Complete. Toggle the Command bit back to 0 (bit 15 in the Input Bits/Input Coil Bits register). The new barcode compare string will be utilized for the next inspection.

Get/Set Exposure Time

Get the current Exposure Time from the iVu Plus.

1. Write the number 10052 as a 16-bit integer into the Command ID register.
2. Toggle the Command bit from 0 to 1 (bit 15 in the Input Bits/Input Coil Bits register).
3. Wait for the Command ACK flag to go from 0 to 1 (bit 15 in the Input Bits ACK/Input Coil Bits ACK register).
4. Verify that the Execution Error flag is not set (i.e. value should be 0). This is bit 15 in the Output Bits/Status Coil Bits register. If the value is 1, read the Error Code register for more information.
5. Task Complete. Toggle the Command bit back to 0 (bit 15 in the Input Bits/Input Coil Bits register). Read the current Exposure Time value (in microseconds) in the Command Response Int32 register.

Set the desired Exposure Time for the iVu Plus.

1. Write the number 52 as a 16-bit integer into the Command ID register.
2. Write the desired Exposure Time (in microseconds) as a 32-bit integer value into the Command Parameter Int32 register. The minimum acceptable value is 117 usec and the maximum value is 1,000,000 usec.
3. Toggle the Command bit from 0 to 1 (bit 15 in the Input Bits/Input Coil Bits register).
4. Wait for the Command ACK flag to go from 0 to 1 (bit 15 in the Input Bits ACK/Input Coil Bits ACK register).
5. Verify that the Execution Error flag is not set (i.e. value should be 0). This is bit 15 in the Output Bits/Status Coil Bits register. If the value is 1, read the Error Code register for more information.
6. Task Complete. Toggle the Command bit back to 0 (bit 15 in the Input Bits/Input Coil Bits register). The new exposure time will be used for the next inspection. Please note that this value is not saved to the iVu's permanent memory unless the Save Configuration task is completed.

Save iVu Configuration

This command saves all modified inspection and configuration parameters to the iVu Plus, including Command Channel changes to exposure time and gain, trigger mode, barcode compare string and/or mask, and Remote Teach sessions.

1. Write the number 102 as a 16-bit integer into the Command ID register.
2. Toggle the Command bit from 0 to 1 (bit 15 in the Input Bits/Input Coil Bits register).
3. Wait for the Command ACK flag to go from 0 to 1 (bit 15 in the Input Bits ACK/Input Coil Bits ACK register).
4. Verify that the Execution Error flag is not set (i.e. value should be 0). This is bit 15 in the Output Bits/Status Coil Bits register. If the value is 1, read the Error Code register for more information.
5. Task Complete. Toggle the Command bit back to 0 (bit 15 in the Input Bits/Input Coil Bits register).

8 Debugging Inspections

8.1 iVu Emulator

The iVu Emulator is a Windows application that allows you to operate in a Windows environment exactly as you would on the iVu Series sensor itself. In general, the Emulator is an inspection debugging tool where you can:

- Import stored inspections and configuration from an iVu Plus BCR sensor.
- Modify inspection parameters on the emulator.
- Restore the updated configuration back to the sensor.

8.2 How to Round-Trip Debug Using the Emulator

The iVu Emulator is a Windows application that allows you to operate in a Windows environment exactly as you would on the sensor itself. In general, the Emulator is an inspection debugging tool: you can import stored inspections and a configuration from an iVu sensor, then modify its parameters on the emulator, and restore the updated configuration back to the sensor. When you install the iVu Emulator, by default, it is installed in the following folder:

C:\Program Files\Banner Engineering\iVu Series

You can run the Emulator from this folder, but you will need to move files between the USB flash drive and PC. To avoid moving files, copy the Emulator executable to the USB flash drive, and run the Emulator directly from the USB flash drive.

This "how-to" describes the procedures for doing round-trip debugging either using the iVu Emulator installed on a PC or using it directly from the USB flash drive.



NOTE: This document refers to saving configuration and inspection logs in folders based on the sensor name. If you have not yet named the sensor, then folders will be named using the first 8-characters of the sensor serial number.

8.2.1 How to Debug Using the Emulator from a PC

1. Plug a USB flash drive into the sensor.
2. Save the Inspection Logs to the USB flash drive.
 - a. On the Main Menu > Inspection Logs > View Logs screen, click the Save icon to save the inspection logs.
 - b. When prompted, select Yes to save sensor configuration along with the Inspection Logs. The location of these files on the USB flash drive displays after the operation is completed. The Inspection Logs are saved in <USB>:\BANNER\<SENSOR_NAME>\InspLog and the sensor configuration is saved in <USB>:\BANNER\<SENSOR_NAME>. For example, if the sensor name is myName:
 - Configuration File (CONFIG.CFG) path: <USB>:\BANNER\myName
 - Inspection Logs path: <USB>:\BANNER\myName\InspLog



NOTE: If the sensor has no name, then the folder name is the first 8-characters of the serial number.

3. Remove the USB flash drive from the sensor and insert it into an available USB port on a Windows PC that has the iVu Emulator installed.



Important: Make sure the iVu Emulator is NOT running before proceeding to the next step.

4. Copy the Sensor Configuration from the USB flash drive to the folder where the Emulator is installed on the PC. For example, if the sensor name is myName and the iVu Emulator is installed in the default location on the PC, copy the file <USB>:\BANNER\myName\CONFIG.CFG to C:\Program Files\Banner Engineering\iVu Series.
5. Copy the Inspection Logs from the USB flash drive (for example, <USB>:\BANNER\myName\InspLog) to the InspLog folder on the PC (for example, C:\Program Files\Banner Engineering\iVu Series\InspLogs).
6. Start the Emulator.
7. Set the Trigger option to Internal—
 - a. Go to Main Menu > Imager > Trigger, and select Internal.
 - b. Set the Trigger Interval as desired.

The iVu Emulator runs with the saved configuration from Step 6 using the saved Inspection Logs from Step 7 as images.

8. Make the desired adjustments.
9. Close the iVu Emulator program. All configuration changes are saved to the CONFIG.CFG file.

10. Copy the sensor configuration (that is, CONFIG.CFG) from the PC working directory to the USB flash drive (for example <USB>:\BANNER\myName\CONFIG.CFG).
11. Remove the USB flash drive from the PC, and connect it to the sensor.
12. Restore the configuration to the sensor.
 - a. Go to Main Menu > System > Configuration > Load Configuration.
 - b. Select the Configuration to restore.
 - c. Click the Load button to start the restore sensor configuration.
 - d. Reboot the sensor when the restore is complete.

8.2.2 How to Debug Using the Emulator from the USB Flash Drive

1. Plug a USB flash drive into the sensor.
2. Save the Inspection Logs to the sensor.
 - a. On the Main Menu > Inspection Logs > View Logs screen, click the Save icon to save the inspection logs.
 - b. When prompted, select Yes to save sensor configuration along with the Inspection Logs. The location of these files on the USB flash drive displays after the operation is completed—the Inspection Logs are saved in <USB>:\BANNER\<SENSOR_NAME>\InspLog and the sensor configuration is saved in <USB>:\BANNER\<SENSOR_NAME>. For example, if the sensor name is myName:
 - Configuration File (CONFIG.CFG) path: <USB>:\BANNER\myName
 - Inspection Logs path: <USB>:\BANNER\myName\InspLog



NOTE: If the sensor has no name, the folder name is the first 8-characters of the serial number.

3. Remove the USB flash drive from the sensor and insert it into an available USB port on a Windows PC that has the iVu Emulator installed.
4. Copy the iVuEmulator.exe program file to the USB flash drive in the same location as the CONFIG.CFG file (for example, <USB>:\BANNER\myName).
5. Launch the <USB>:\BANNER\myName\iVuEmulator.exe program.
6. Set the Trigger option to Internal—
 - a. Go to Main Menu > Imager > Trigger, and select Internal.
 - b. Set the Trigger Interval as desired.

The iVu Emulator runs with the saved configuration using the saved Inspection Logs as images.
7. Make the desired adjustments.
8. Close the iVu Emulator program. All configuration changes are saved to the CONFIG.CFG file.
9. Remove the USB flash drive from the PC, and connect it to the sensor.
10. Restore the configuration to the sensor.
 - a. Go to Main Menu > System > Configuration > Load Configuration.
 - b. Select the Configuration to restore.
 - c. Click the Load button to start the restore sensor configuration.
 - d. Reboot the sensor when the restore is complete.

9 Updating the Sensor

9.1 Update Process

Banner Engineering may release new versions of the sensor firmware in the future. New firmware releases can be downloaded from Banner's website or can be obtained by ordering the latest Product CD. The following steps will guide you through the process of updating the iVu firmware.

Step 1: Copy firmware of the desired product to USB flash drive.

1. Launch the iVu Series software.

From the Product CD:

- Place the latest Product CD into your CD ROM drive. The iVu Series Software automatically starts.
- If your computer is not set for Auto-Play, start the iVu Series Software by browsing to the CD drive from the My Computer screen and double-clicking on 'iVuSeries.exe'.

From the Banner Website:

1. Visit Banner's Website: <http://www.bannerengineering.com>.
 2. Browse to the Vision Products page and select the iVu product you are using.
 3. Click on the Software tab to view software releases.
 4. Determine which version you want to download (the Current Version is recommended, for example "iVu Series Software Version 2010R4").
 5. Click on the circular Download button. This initiates the download process. Depending on your browser settings, you may be asked to confirm or provide a location to save the file. Choose to download on your desktop. Note the file name.
 6. Double-click the file to start extracting the files and run the iVu Series Software.
2. Select the product you are using and browse to the Firmware Update page.
 3. Click on the 'Run Firmware Update Wizard' and the program starts.
 4. Follow the on-screen instructions. Clicking on 'Copy firmware to USB' copies the selected firmware to the USB flash drive.

Step 2: Install the firmware on the iVu.

1. Remove the USB flash drive from the PC, and plug it into the sensor.
2. On the sensor, select System > Firmware Update. The name of the firmware file you copied on the USB flash drive displays.
3. Choose the correct file and click on the Load button.
4. Follow the on-screen instructions to update the firmware.

9.2 How to Set or Modify a Device Name using the Emulator

You can set a Device Name for your iVu Series sensor or modify an existing name on the sensor using the software keypad. You can also change the device name this using the iVu Emulator as described below.



NOTE: If you are in a language other than English, you cannot modify the device name using the software keypad. Use the procedure described below.



NOTE: If you have not set the device name previously, then folders will be named using the first 8-characters of the device serial number.

1. Plug a USB flash drive into the device.
2. Save the Device Configuration to the USB flash drive (Main Menu > System > Configuration > Save to USB). The location of these files on the USB flash drive displays after the operation is complete—the device configuration is saved in <USB>:\BANNER\<DEVICE_NAME>. For example, if the device name is myName:, the path will be <USB>:\BANNER\myName).
3. Remove the USB flash drive from the device and insert it into an available USB port on a Windows PC.
4. If you are running the Emulator from the USB flash drive, launch the iVuEmulator.exe program. If you are running the Emulator installed on a PC, make sure the Emulator is not running, and copy the Device Configuration from the USB flash drive to the folder where the Emulator is installed on the PC. For example, if the device name is myName

and the iVu Emulator is installed in the default location on the PC, copy the file <USB>:\BANNER\myName\CONFIG.CFG to C:\Program Files\Banner Engineering\iVu Series.

5. Launch the iVuEmulator.exe program.
6. Go to the Information screen (Main Menu > System > Information).
7. Click the white box next to the Device Name label, and enter the desired Device Name.
8. Click the Back button on the lower-left corner of the screen to save the Device Name.
9. Close the Emulator program and the Device Name is saved to the CONFIG.CFG file.
10. If you are running the Emulator on the PC, copy the CONFIG.CFG file back to the original folder on the USB flash drive—<USB>:\BANNER\<DEVICE_NAME> (for example <USB>:\BANNER\myName).



NOTE: The device looks in the original folder (for example, myName) for the CONFIG.CFG file.

11. Remove the USB flash drive from the PC, and connect it to the device.
12. Restore the configuration to the device.

- a. Go to Main Menu > System > Configuration > Load from USB.
- b. Select the Configuration to restore.
- c. Click the Load button to start the restore device configuration.



NOTE: After the new device name is restored in the device, all files saved to USB flash drive will now reside in the folder corresponding to the new device name.

- d. Reboot the device when the restore is complete.



NOTE: If a Device Configuration from one device is loaded onto another device, the Device Name from the Device Configuration will not be stored in the device.

9.3 How to Reset the Sensor Password

If you forget the password for your sensor, you can remove the current password using a reset key that is generated by the Password Reset Utility, which is located on the Product CD. The following steps will guide you through the specific steps to reset the password:

1. On your iVu Series sensor, click the Forgot? button located on the bottom of the Enter Current Password screen.
2. Write down the 6-digit Device Key.
3. On a Windows PC, insert the iVu product CD into the CD ROM drive.
4. From the product CD menu (started upon inserting the CD), launch the Password Reset Utility.
5. Enter the Device Key into the text box in the Utility—identified as Step 1 in the Password Reset Utility.
6. Click the Generate Reset Key button.
7. Write down the four-digit Password Reset Key—identified as Step 2 in the Password Reset Utility.
8. On the iVu Series sensor, check the Next button on the Password Reset screen.
9. Enter the 4-digit reset key on the Enter Reset Key screen.
10. Click Apply.

The password is now cleared.

9.4 How to Use Bitmap Image Files with the iVu Emulator

You can use bitmap (.bmp) image files with the iVu Emulator for developing and simulating iVu inspections. The iVu Emulator only accepts image files in .bmp format. If you have other image file formats, use an image viewer/editor program, such as PhotoShop, Gimp, or Paint, to convert the files to 8-bit grayscale .bmp format.



NOTE: Images smaller than 640 × 480 are black-filled starting in the upper-right. Images larger than 640 × 480 are cropped starting in the upper-left.

1. Copy the .bmp files into the InspLog folder in the iVu Emulator install folder.

For example, copy .bmp files into the C:\Program Files\Banner Engineering\iVu Series\InspLog folder.



NOTE: Remove any existing .bmp or Log files in that folder to avoid confusion because the iVu Emulator automatically runs all .bmp/Log files sequentially according to filename.

2. Launch the iVu Emulator program.

3. Select Internal Trigger on the Trigger Selection screen (Main Menu > Image > Trigger).
4. Set the Trigger Interval as desired.

The iVu Emulator runs using the .bmp files from Step 1.



NOTE: Banner does not recommend setting up inspections using these 8-bit grayscale images because you will always end up modifying the configuration after loading it on the sensor on the line. A better choice is to set up the inspection on the iVu Emulator using the Inspection Logs from the sensor.

10 LED Indicator Troubleshooting

In normal operation, the Power LED is steady green, and the Pass/Fail is green or red depending on the triggered inspection. The Ethernet I/O LED will be lit or off depending on connection status.



| | | |
|---|------------------|--|
| 1 | Power LED | Green: Power Red: Error |
| 2 | Pass/Fail LED | Green: Pass Red: Fail |
| 3 | Ethernet I/O LED | Green: Connected No Light: Disconnected |

The iVu also indicates abnormal conditions as described below.

10.1 Errors

| Problem Indicator | Solution |
|--|---|
| The Pass/Fail LED is blinking green a number of times, separated by an LED red blink, and the sensor repeats this pattern over and over. This indicates that no inspections are occurring. | Reboot the sensor. |
| The Power LED is lit steady red. These type of errors are reported in the System log and appear highlighted in red. | Do the following: <ol style="list-style-type: none"> 1. Look in the System Log to see the error. 2. Clear the LED; that is, go to the Main Menu > Logs > System Logs and press the Clear System Error button at the bottom of the screen (a sensor reboot is not required). 3. If the error occurs again, you can try rebooting the sensor to see if that fixes the problem. If the problem persists, contact Banner customer support. |

10.2 Warnings

Warnings are atypical conditions that the sensor detects and fixes. Warning are highlighted in yellow in the System Log, and can typically be ignored.

11 Product Support and Maintenance

This section provides general Banner resources and specific documentation for installers and operators of this iVu Plus BCR Vision Sensor.



WARNING: Not To Be Used for Personnel Protection

Never use this device as a sensing device for personnel protection. Doing so could lead to serious injury or death. This device does not include the self-checking redundant circuitry necessary to allow its use in personnel safety applications. A sensor failure or malfunction can cause either an energized or de-energized sensor output condition.

11.1 Product Support

Banner provides the following resources for quickly setting up and operating the device.

Documentation

Online Help

When setting up or monitoring inspections using the iVu sensor's integrated display, you can get online help on any screen by clicking the Help icon in the upper-right of the screen.

PDF Documentation

The product documentation is available in a convenient printable format (PDF) on the installation CD or at www.bannerengineering.com.

Banner Website

The most current product information, documentation, and software updates are available on the Banner website: www.bannerengineering.com.

Warranty Service

Contact Banner Engineering for troubleshooting of this device. Do not attempt any repairs to this Banner device; it contains no field-replaceable parts or components. If the device, device part, or device component is determined to be defective by a Banner Applications Engineer, they will advise you of Banner's RMA (Return Merchandise Authorization) procedure.



Important: If instructed to return the device, pack it with care. Damage that occurs in return shipping is not covered by warranty.

Factory Support

To help Banner better assist you, be ready to provide the following information:

- iVu firmware version (to find the version number, click Main Menu > System > Sensor Information)
- Device Model Number and Date Code, which are found on the bottom of the device.
- Exact wording of any messages that appeared on your screen
- A description of what you were doing and what happened
- A description of how you tried to solve the problem
- Error Codes (see [LED Indicator Troubleshooting](#) on page 175)

11.2 Maintenance

Maintenance tasks include keeping the hardware free of dust and dirt and possibly updating the iVu firmware as new versions become available.

Cleaning the Sensor

Regularly remove any dust or dirt from the device using a soft cloth. If needed, slightly dampen the cloth with a weak solution of neutral detergent. Avoid getting dirt on the imager (the area behind the lens). If the imager is dirty, use anti-static compressed air to blow off the dust.

Updating the iVu firmware

The current version of iVu firmware is available for download from the Banner website. See the Banner Website for the firmware download link.

11.3 Contact Us

Corporate Headquarters

Address:
Banner Engineering Corporate
9714 Tenth Avenue North
Minneapolis, Minnesota 55441, USA

Phone: +1 763 544 3164
Website: www.bannerengineering.com

Europe

Address:
Banner Engineering EMEA
Park Lane Culliganlaan 2F
Diegem B-1831, Belgium

Phone: +32 (0)2 456 0780
Website: www.bannerengineering.com/eu
Email: mail@bannerengineering.com

Turkey

Address:
Banner Engineering Turkey
Barbaros Mah. Uphill Court Towers A Blok D:49
34746 Batı Ataşehir İstanbul Türkiye

Phone: +90 216 688 8282
Website: www.bannerengineering.com.tr
Email: turkey@bannerengineering.com.tr

India

Address:
Banner Engineering India Pune Head Quarters
Office No. 1001, 10th Floor Sai Capital, Opp. ICC Senapati Bapat Road
Pune 411016, India

Phone: +91 (0) 206 640 5624
Website: www.bannerengineering.co.in
Email: salesindia@bannerengineering.com

Mexico

Address:
Banner Engineering de Mexico Monterrey Head Office
Edificio VAO Av. David Alfaro Siqueiros No.103 Col. Valle Oriente C.P.66269
San Pedro Garza Garcia, Nuevo Leon, Mexico

Phone: +52 81 8363 2714 or 01 800 BANNERE (toll free)
Website: www.bannerengineering.com.mx
Email: mexico@bannerengineering.com

Brazil

Address:
Banner do Brasil
Rua Barão de Teffé nº 1000, sala 54
Campos Eliseos, Jundiaí - SP, CEP.: 13208-761, Brasil

Phone: +1 763 544 3164
Website: www.bannerengineering.com.br
Email: brasil@bannerengineering.com

China

Address:
Banner Engineering Shanghai Rep Office
Xinlian Scientific Research Building Level 12, Building 2
1535 Hongmei Road, Shanghai 200233, China

Phone: +86 212 422 6888
Website: www.bannerengineering.com.cn
Email: sensors@bannerengineering.com.cn

Japan

Address:
Banner Engineering Japan
Cent-Urban Building 305 3-23-15 Nishi-Nakajima Yodogawa-Ku
Osaka 532-0011, Japan

Phone: +81 (0)6 6309 0411
Website: www.bannerengineering.co.jp
Email: mail@bannerengineering.co.jp

Taiwan

Address:
Banner Engineering Taiwan
8F-2, No. 308 Section 1, Neihsu Road
Taipei 114, Taiwan

Phone: +886 (0)2 8751 9966
Website: www.bannerengineering.com.tw
Email: info@bannerengineering.com.tw

South Korea

Address:
Banner Engineering Korea
8th Fl, CM Bldg, 32-7, Songpa-Dong Songpa-Gu
Seoul 138-849, South Korea

Phone: +82 (0)2 417 0285
Website: www.bannerengineering.co.kr
Email: info@bannerengineering.co.kr

11.4 Banner Engineering Corp Limited Warranty

Banner Engineering Corp. warrants its products to be free from defects in material and workmanship for one year following the date of shipment. Banner Engineering Corp. will repair or replace, free of charge, any product of its manufacture which, at the time it is returned to the factory, is found to have been defective during the warranty period. This warranty does not cover damage or liability for misuse, abuse, or the improper application or installation of the Banner product.

THIS LIMITED WARRANTY IS EXCLUSIVE AND IN LIEU OF ALL OTHER WARRANTIES WHETHER EXPRESS OR IMPLIED (INCLUDING, WITHOUT LIMITATION, ANY WARRANTY OF MERCHANTABILITY OR FITNESS FOR A PARTICULAR PURPOSE), AND WHETHER ARISING UNDER COURSE OF PERFORMANCE, COURSE OF DEALING OR TRADE USAGE.

This Warranty is exclusive and limited to repair or, at the discretion of Banner Engineering Corp., replacement. IN NO EVENT SHALL BANNER ENGINEERING CORP. BE LIABLE TO BUYER OR ANY OTHER PERSON OR ENTITY FOR ANY EXTRA COSTS, EXPENSES, LOSSES, LOSS OF PROFITS, OR ANY INCIDENTAL, CONSEQUENTIAL OR SPECIAL DAMAGES RESULTING FROM ANY PRODUCT DEFECT OR FROM THE USE OR INABILITY TO USE THE PRODUCT, WHETHER ARISING IN CONTRACT OR WARRANTY, STATUTE, TORT, STRICT LIABILITY, NEGLIGENCE, OR OTHERWISE.

Banner Engineering Corp. reserves the right to change, modify or improve the design of the product without assuming any obligations or liabilities relating to any product previously manufactured by Banner Engineering Corp.

Index

A

Advanced 32
auto exposure 33

C

command channel
 image export 55
command channel log 63
command channel sample
 application 54
command group
 history 72
 info 69
 inspection 72
 productchange 71
 status 70
 system 69
 trigger 70
communication channel
 command channel 53
 data export 53
 image export 53
 Industrial Ethernet 53
Communication Logs 47
communications channels 53
Configuration menu 22

D

DAP 113, 117–119, 123, 125, 127
data export 53
data export log 63
data export sample application 55
data model 113, 117–119, 123,
 125, 127
debugging 170
Device Access Point
 , See DAP
device control 118
Display Settings menu 31

E

emulator 170
Ethernet 6, 53
ethernet communications 56
exposure 33
external strobe 36

F

fail hold time 32

field of view
 adjust 37
firmware update 33
focus number 35

G

gain 34
Generic Station Description
 , See GSD

GSD
 Install 129

H

history command group 72
home screen 16

I

image export 53, 55
image export sample application 56
imager
 auto exposure 33
 exposure 33
 gain 34
 resolution 37
 trigger 34, 35
imager menu 33
Industrial Ethernet 53
info command group 69
Information 23
inspection command group 72
Inspection Logs 45
inspection menu 38
inspection results 118
internal strobe 36
iVu emulator 170

L

LCD Timeout 32
Load from USB 23
lock sensor 24
logs
 command channel 63
 data export 63
 communication 47
 inspection 45
 system 47

M

menu
 Display Settings 31
 Configuration 22
 Mode 22
 System 21

Mode menu 22
model 117

P

productchange command group 71

R

resolution 37
RS-232 6, 53

S

sample application
 command channel 54
 data export 55
 image export 56
Save to USB 23
sensor display 16
status command group 70
strobe
 external 36
 internal 36
submodule 118, 119, 123, 125,
 127
system command group 69
System Logs 47
System menu 21

T

Touchscreen Calibration 32
trigger 34, 35
trigger command group 70

U

USB
 loading from 23
 saving to 23