

en 02-2015/05 50110218



M8
2.5 mm
4 mm



10 - 30 V
DC
non-embedded
5 kHz

- Slim and short cylindrical metal housing M8
- Stainless steel housing
- Built-in short circuit protection, inductive protection and polarity reversal protection
- LED for switching state visible from 360°

Dimensioned drawing

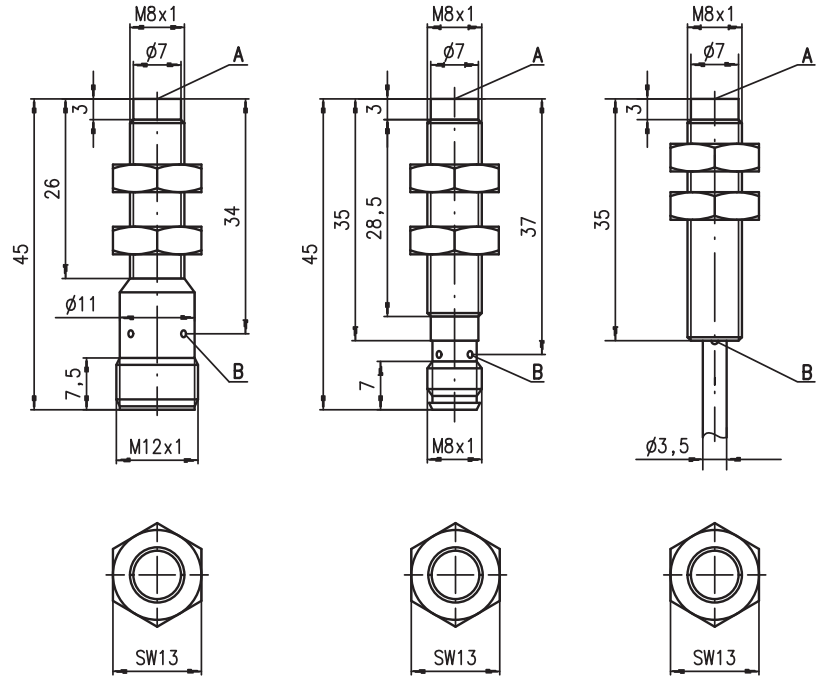

Tightening torque of the fastening nuts < 10Nm !

- A** Active surface
- B** Yellow indicator diode

Electrical connection

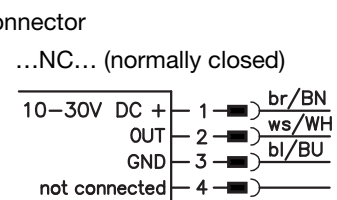
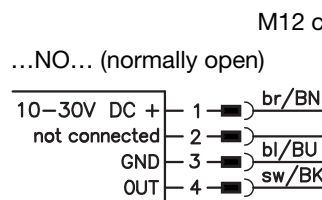
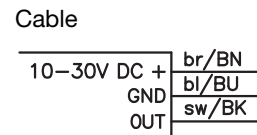
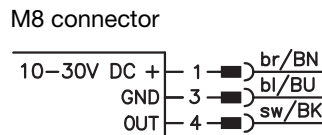

...NO...-S12 (normally open):
...NC...-S12 (normally closed):

3-pin or 4-pin M12 connection cables can be used.
only 4-pin M12 connection cables can be used.

Accessories:

(available separately)

- M8 connectors (D M8...)
- M12 connectors (KD ...)
- Ready-made cables (K-D ...)
- Mounting clamp (MC 008...)

We reserve the right to make changes • DS_IS208N_en_50110218.fm



Specifications

General specifications

Type of installation
 Typ. operating range limit S_n
 Operating range S_a

IS 208...-2N5...

non-embedded installation
 2.5mm
 0 ... 2.0mm

IS 208...-4N0...

4.0mm
 0 ... 3.2mm

Electrical data

Operating voltage U_B 1)
 Residual ripple σ
 Output current I_L
 Open-circuit current I_0
 Residual current I_r
 Switching output/function

10 ... 30VDC
 $\leq 20\%$ of U_B
 ≤ 200 mA
 ≤ 10 mA
 $\leq 100\mu$ A
 .../4NO... PNP transistor, make-contact (NO)
 .../4NC... PNP transistor, break-contact (NC)
 .../2NO... NPN transistor, make-contact (NO)
 .../2NC... NPN transistor, break-contact (NC)

Voltage drop U_d
 Hysteresis H of S_r
 Temperature drift of S_r
 Repeatability

≤ 2 V
 $\leq 5\%$
 $\leq 10\%$ 2)
 $\leq 4.8\%$ 3)

Timing

Switching frequency f
 Delay before start-up

5kHz
 ≤ 10 ms
 3.5kHz

Indicators

Yellow LED (visible from 360°)

switching state

Mechanical data

Housing
 Standard surface plate
 Active surface
 Weight (M8 plug/cable)
 Connection type

stainless steel
 8 x 8mm², Fe360
 PBTP
 approx. 12g/approx. 70g
 M8 connector, 3-pin, or
 M12 connector, 4-pin, or
 cable: 2m, PVC, 3 x 0.14mm², \varnothing 3.5mm
 12 x 12mm², Fe360

Environmental data

Ambient temperature
 Protection class
 Protective circuit 4)
 Standards applied
 Electromagnetic compatibility

-25°C ... +70°C
 IP 67
 1, 2, 3
 IEC/EN 60947-5-2
 IEC 60255-5
 IEC 61000-4-2
 IEC 61000-4-3
 IEC 61000-4-4
 1kV
 Level 3 air 8kV (ESD)
 Level 3 10V/m (RFI)
 Level 3 2kV (Burst)

- 1) Observe the safety regulations and installation instructions regarding power supply and wiring; for UL applications: only for use in "Class 2" circuits acc. to NEC
- 2) Over the entire operating temperature range
- 3) For $U_B = 20 \dots 30$ VDC, ambient temperature $T_a = 23^\circ\text{C} \pm 5^\circ\text{C}$
- 4) 1=polarity reversal protection, 2=short circuit protection, 3=inductive protection for all outputs

Remarks

Operate in accordance with intended use!

- ⚠ This product is not a safety sensor and is not intended as personnel protection.
- ⚠ The product may only be put into operation by competent persons.
- ⚠ Only use the product in accordance with the intended use.

Tables

Reduction factors:

for $S_n = 2.5$ mm		for $S_n = 4.0$ mm	
Steel Fe360	1	Steel Fe360	1
Copper	0.20	Copper	0.42
Aluminum	0.25	Aluminum	0.45
Brass	0.35	Brass	0.52
Stainless steel	0.70	Stainless steel	0.74

Mounting

Non-embedded installation:

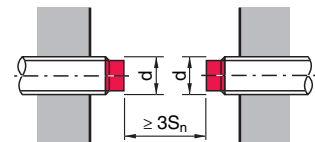
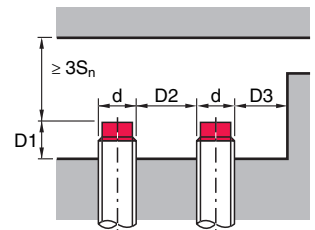

Ferromagnetic and non-ferromagnetic materials

S_n [mm]	D1 [mm]	D2 [mm]	D3 [mm]
2.5	8.0	10.0	4.0
4.0	6.0	14.0	6.0

Diagrams

Models with $s_n = 2.5$ mm

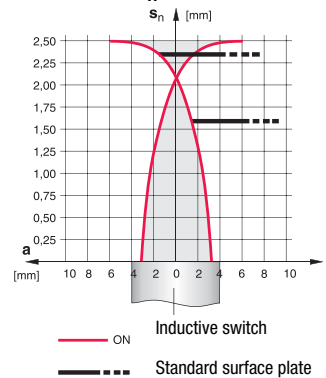

Models with $S_n = 4.0$ mm

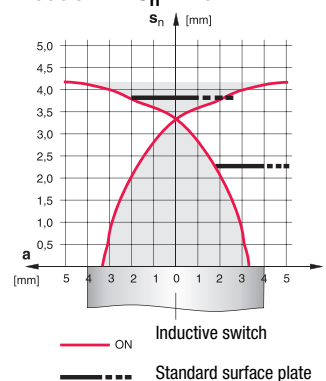

Type key

I	S	2	0	8	/	M	M	/	4	N	0	-	2	N	5	-	S	8	.	3
---	---	---	---	---	---	---	---	---	---	---	---	---	---	---	---	---	---	---	---	---

Operating principle / construction
IS Inductive switch / Standard

Series
208 series with M8 x 1 external thread

Housing / thread
MM metal housing (active surface: plastic) / metric thread

Output function
4NO PNP transistor, make-contact (NO)

4NC PNP transistor, break-contact (NC)

2NO NPN transistor, make-contact (NO)

2NC NPN transistor, break-contact (NC)

Measurement range / type of installation
2N5 typ. scan range limit 2.5 mm / non-embedded installation

4N0 typ. scan range limit 4.0 mm / non-embedded installation

Electrical connection
N/A cable, PVC, standard length 2000 mm

S8.3 M8 connector, 3-pin, axial

S12 M12 connector, 4-pin, axial

200-S8.3 cable, PVC, length 200 mm with M8 connector, 3-pin, axial

Order guide

The sensors listed here are preferred types; current information at www.leuze.com.

	Designation	Part No.
S_n = 2.5mm	IS 208 MM/4NO-2N5	50109645
	IS 208 MM/4NO-2N5-S8.3	50109646
	IS 208 MM/4NO-2N5-S12	50109647
	IS 208 MM/4NC-2N5-S8.3	50129347
S_n = 4mm	IS 208 MM/4NO-4N0	50109658
	IS 208 MM/4NO-4N0-S8.3	50109659
	IS 208 MM/4NC-4N0	50129349
	IS 208 MM/4NC-4N0-S8.3	50109660
	IS 208 MM/2NO-4N0	50109661
	IS 208 MM/2NO-4N0-S8.3	50109662
	IS 208 MM/2NC-4N0-S8.3	50109663

