

(I)PRK 18

Retro-reflective photoelectric sensors with polarization filter

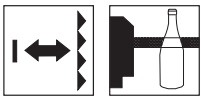

en 09-2015/01 50109446-02



0 ... 4m

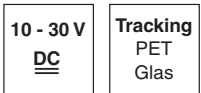

- Intelligent sensor for detection of transparent objects (e.g. clear glass, PET, foil)
- Automatic contamination compensation (tracking function) for longer intervals between cleanings
- Adjustment via teach-in

Dimensioned drawing

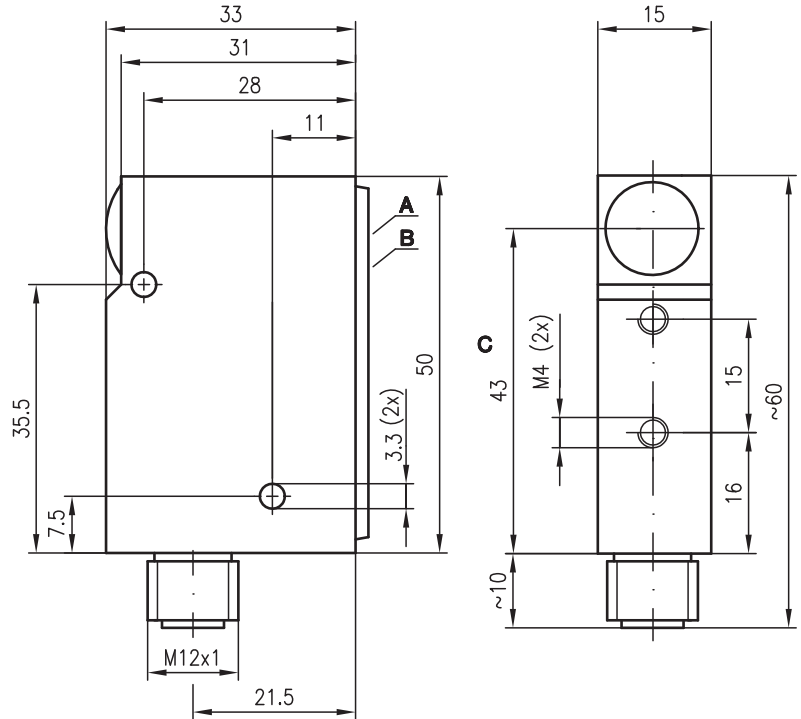

- A** Step switch for object adjustment
- B** Indicator diodes
- C** Optical axis

Electrical connection

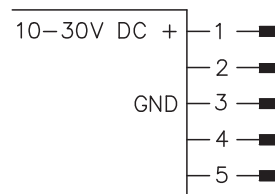

	PIN 1	PIN 2	PIN 3	PIN 4	PIN 5
PRK 18/24 DL.46	+	NPN	GND	PNP	L/D
PRK 18/24 DL.42	+	NPN	GND	PNP	Teach
PRK 18/44 L.43	+	PNP	GND	PNP	Teach
IPRK 18/4 DL.41	+	Warn	GND	PNP	L/D
IPRK 18/2 DL.41	+	Warn	GND	NPN	L/D

Accessories:

(available separately)

- Mounting system (BT 95)
- M12 connectors (KD ...)
- Reflectors

We reserve the right to make changes • DS_IPRK18xxDL4x_en_50109446-02_fm



Specifications

Optical data

Typ. operating range limit (TK(S) 100x100)¹⁾ 0 ... 4m
 Operating range²⁾ see tables
 Recommended reflector MTKS 50x50.1
 Light source LED (modulated light)
 Wavelength 660nm (visible red light, polarized)

Timing

Switching frequency 1kHz
 Response time 0.5ms
 Delay before start-up ≤ 300ms

Electrical data

Operating voltage U_B ³⁾ 10 ... 30VDC (incl. residual ripple)
 Residual ripple ≤ 15% of U_B
 Open-circuit current ≤ 35mA
 Switching output see section 6. Preferred types
 Warning output see section 6. Preferred types
 Function characteristics see section 6. Preferred types
 Signal voltage high/low⁴⁾ $\geq (U_B - 2V) / \leq 2V$
 Output current max. 2x100mA
 Sensitivity see section 6. Preferred types

Switch positions

Position **teach-in** activation of the teach event
 Position **1** (PET bottle) operating point PET bottle
 Position **2** (clear glass bottle) operating point clear glass bottle
 Position **3** (colored glass bottle) operating point colored glass bottle
 Position **Auto** Tracking ON/OFF

Indicators

Green LED, continuous light ready
 Green LED, flashing teach mode active with performance reserve
 Red LED, continuous light operation without performance reserve
 Red LED, flashing teaching without performance reserve
 Green/red LED flashing device defective, no performance reserve
 LED 1, yellow light path free
 LED 2, yellow tracking ON

Mechanical data

Housing diecast zinc
 Optics cover glass
 Weight 150g
 Connection type M12 connector, 5-pin, stainless steel

Environmental data

Ambient temp. (operation/storage) -25°C ... +55°C / -40°C ... +70°C
 Protective circuit⁵⁾ 2, 3
 VDE safety class III
 Protection class IP 67, IP 69K⁶⁾
 LED class 1 (acc. to EN 62471)
 Standards applied IEC 60947-5-2
 Certifications UL 508, C22.2 No.14-13^{3) 7)}

Options

Teach input see section 6. Preferred types
 Active/not active edge from 0V to $U_B/0V$ or not connected
 Teach delay < 500ms
L/D input see section 6. Preferred types
 Dark/light switching ...DL... 0V or not connected/ U_B
 ...L... $U_B/0V$ or not connected
 L/D delay < 500ms
Warning output warn see section 6. Preferred types
 Signal voltage high/low $\geq (U_B - 2V) / \leq 2V$
 Output current max. 100mA

- 1) Typ. operating range limit: max. attainable range without performance reserve
- 2) Operating range: recommended range with performance reserve
- 3) For UL applications: for use in class 2 circuits according to NEC only
- 4) Functional extra-low voltage with reliable disconnection or protective extra-low voltage (VDE 0100/T 410)
- 5) 2=polarity reversal protection, 3=short circuit protection for all outputs
- 6) IP 69K test acc. to DIN 40050 part 9 simulated, high pressure cleaning conditions without the use of additives, acids and bases are not part of the test
- 7) These proximity switches shall be used with UL Listed Cable assemblies rated 30V, 0.24A min, in the field installation, or equivalent (categories: CYJV/CYJV7 or PVVA/PVVA7)

Operate in accordance with intended use!

- ⚠ This product is not a safety sensor and is not intended as personnel protection.
- ⚠ The product may only be put into operation by competent persons.
- ⚠ Only use the product in accordance with the intended use.

Order guide

See section 6. Preferred types

Tables

Reflectors			Operating range
1	TK(S)	100x100	0 ... 3.0m
2	MTKS	50x50.1	0 ... 2.4m
3	TK(S)	30x50	0 ... 1.6m
4	TK(S)	20x40	0 ... 1.4m
5	Tape 6	50x50	0 ... 2.0m

1	0	3.0	4.0
2	0	2.4	3.0
3	0	1.6	2.0
4	0	1.4	1.8
5	0	2.0	2.2

□ Operating range [m] *)
 □ Typ. operating range limit [m] *)

*) for sensitivity setting at switch position 3

TK ... = adhesive
 TK(S) ... = screw type
 Tape 6 = adhesive

Diagrams

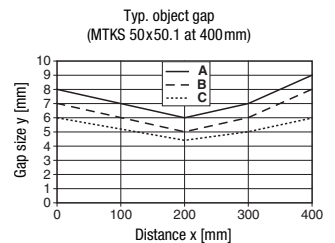

- A Switch position 1
- B Switch position 2
- C Switch position 3

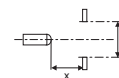

Remarks

Objects	Switch position
Multilayer foil, PET bottles, transparent glass pane	1
Clear glass bottle	2
Colored glass bottle	3

- Teach event may only be performed with free light path.
- A change of the operating point is always possible and does not require a new teach-in.
- The red LED signals an insecure operating state. The warning output is set.
- For activation of the single functions you have to remain in the respective switch position for approx. 2ms.
- In switch positions "Teach" and "Auto" the switching outputs are active.
- Warning output: static signal for control limit reached.
- The light spot may not exceed the reflector.
- Preferably use MTK(S) or tape 6.
- For foil 6 the sensor's side edge must be aligned parallel to the side edge of the reflective tape.

(I)PRK 18

1. Operating principle of contamination compensation (tracking function)

This transparency sensor (clear glass sensor) is a device which automatically compensates system contamination at the reflector and sensor by means of continuous measurement of the receiving level. The control rate depends on the number of gaps in the process. This tracking function increases the interval between cleaning sessions considerably.

The control limit is indicated by a warning output. The sensor does not need to be re-calibrated after the system has been cleaned. In typical applications, cleaning can be performed during system operation. This means higher system efficiency.

The system is calibrated ("teach-in") once only at initial commissioning. The appropriate object is then selected (PET, clear glass or colored glass). The "teach-in" process does not have to be performed again if a different object is selected.

2. Controls and indicators

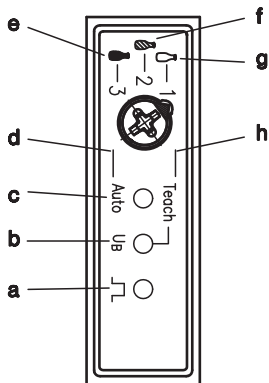

- a Light path free (LED 1 yellow)
- b Operation and teach indicator (LED green/red)
- c Tracking ON (LED 2 yellow)
- d Switch position tracking
- e Switch position 3 (colored-glass bottle)
- f Switch position 2 (clear-glass bottle)
- g Switch position 1 (PET bottle, glass pane, foil)
- h Switch position Teach

3. Adjustment procedure (teach-in) via step switch

	Correct adjustment procedure:	Important to note:
	<p>1. There must be no objects in the beam path between the retro-reflective photoelectric sensor and the reflector during the adjustment procedure.</p>	<p>The teach-in procedure must be conducted without any objects!</p>
	<p>2. Align the sensor with the reflector so that the light spot is visible in the middle of the reflector.</p>	<p>The light spot must not fall outside the reflector area. The mounted reflector should always be larger than the visible light spot!</p>
	<p>3. Turn the step switch to the "Teach" switch position for about 2s.</p> <p>4. Turn the step switch back to switch positions 1, 2 or 3.</p>	<p>The adjustment procedure must be conducted without objects!</p>
	<p>5. To turn the tracking function on/off, turn the step switch to the "Auto" switch position for about 2s.</p> <p>6. Turn the step switch back to switch positions 1, 2 or 3.</p>	<p>The step switch must be turned to switch positions 1, 2 or 3 during operation!</p>

4. Setting operating mode

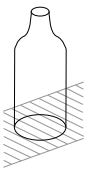
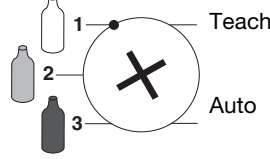
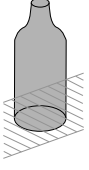
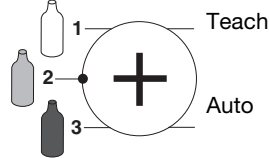
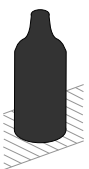
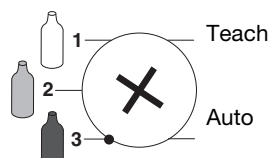
Object to be detected	Material, e.g.:	Switch position	Correct adjustment procedure:
① Transparent objects 	<ul style="list-style-type: none"> ● PET bottle ● PEN bottle ● Clear plate glass ● Foil 		<ol style="list-style-type: none"> 1. Turn the step switch to the "Teach" switch position for about 2s. 2. Turn the step switch back to switch position 1. <p>Tracking can be turned on or off by switching to the "Auto" switch position.</p>
≅ Less transparent objects 	<ul style="list-style-type: none"> ● Clear glass bottle ● Colored plate glass 		<ol style="list-style-type: none"> 1. Turn the step switch to the "Teach" switch position for about 2s. 2. Turn the step switch back to switch position 2. <p>Tracking can be turned on or off by switching to the "Auto" switch position.</p>
≅ Opaque objects 	<ul style="list-style-type: none"> ● Colored glass bottle ● Opaque objects 		<ol style="list-style-type: none"> 1. Turn the step switch to the "Teach" switch position for about 2s. 2. Turn the step switch back to switch position 3. <p>Tracking can be turned on or off by switching to the "Auto" switch position.</p>

5. Calibration procedure (teach-in) by cable

1. Set step switch to desired operating mode (PET, clear-glass or colored-glass bottle).
2. Activate teach-in cable (pin 5) (high active). Teach event takes max. 1s.
3. Deactivate teach-in cable (pin 5).

6. Preferred types

Selection table		PRK 18/24 DL.46 Part no. 50032798	PRK 18/24 DL.42 Part no. 50033554	PRK 18/44 L.43 Part no. 50115193	IPRK 18/4 DL.41 Part no. 50033552	IPRK 18/2 DL.41 Part no. 50033553		
Order code →								
Equipment ↓								
Application	PET	●	●	●	●	●		
	clear glass	●	●	●	●	●		
	colored glass	●	●	●	●	●		
Switching outputs	2 PNP transistors			●	●			
	2 NPN transistors					●		
	1 NPN + 1 PNP transistor	●	●					
Function characteristics	antivalent			●				
	light switching	●			●	●		
	dark switching	●	●		●	●		
Configuration	step switch	●	●	●	●	●		
Options	contamination compensation (step tracking)	●	●	●	●	●		
	cleaning compensation (peak tracking)	●	●	●	●	●		
	tracking ON/OFF	●	●	●	●	●		
	warning output				●	●		
	Teach-in via step switch	●	●	●	●	●		
	Teach via control cable		●	●				
	light/dark switching via control cable	●			●	●		
UL	●	●		●	●			