

HT49C RELAIS Diffuse reflection light scanners with background suppression

en 02-2015/08 50128462-01

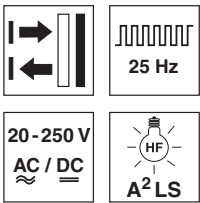

5 ... 3000 mm
1200mm with
black-white error < 10%

- Scanner with adjustable background suppression in red light and infrared light version
- Reliable detection of objects with different surface structures
- Robust plastic housing, degree of protection IP 67 and IP 69K for universal, industrial application
- All-mains design 20 ... 250VAC/DC with relay output (potential-free)
- Large adjustment range and minimal zero distance for optimum adaptation to the application
- Light/dark switching and time module activation via teach button for time-saving integration in existing evaluation environment:
- Space-saving installation thanks to front access to the connection compartment
- Extremely time-saving connection by means of spring terminals (up to 1.5mm²)
- A²LS - Active Ambient Light Suppression
- Optics heating



Accessories:

(available separately)

- Mounting systems (BTU 460, BT 96, BT 96.1, BT 450.1-96)
- Spark extinction

Dimensioned drawing

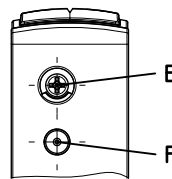
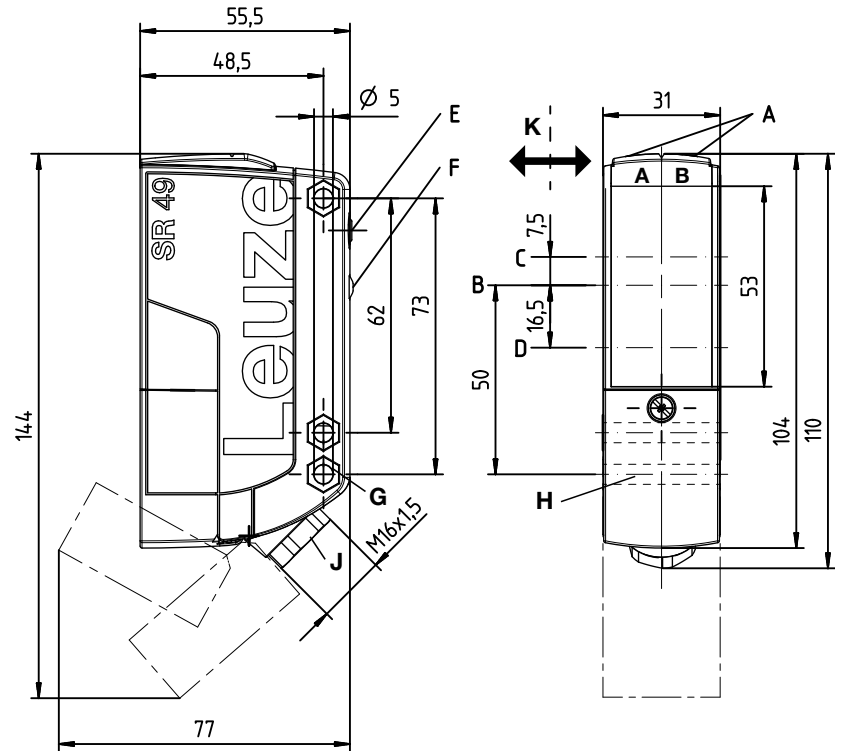

- A_A** Green indicator diode
- A_B** Yellow indicator diode
- B** Optical axis
- C** Receiver
- D** Transmitter
- E** Scanning range adjustment
- F** Teach button for light/dark switching / time module activation
- G** Countersinking for SK nut M5, 4.2 deep
- H** Connection compartment with spring terminals
- J** Cable entry with M16x1.5 screw fitting for Ø5 ... 10mm
- K** Preferred entry direction

Electrical connection

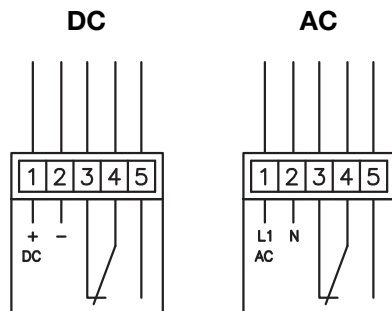

Wire color of connecting cable

Pin	Color
1	BR / BN
2	BL / BU
3	WS / WH
4	GR / GY
5	SW / BK

We reserve the right to make changes • DS_HT49CUCTS_en_50128462_01.fm

Specifications

Optical data

Typ. scanning range limit (white 90%) ¹⁾
 Scanning range ²⁾
 Black-white error
 Adjustment range
 Light source
 Wavelength

HT49C...

5 ... 3000mm
 see diagrams
 <10% up to 1200mm
 120 ... 3000mm
 LED (modulated light)
 630nm (red light)

HT49CI...

860nm (infrared light)

Timing

Switching frequency 25Hz
 Response time 20ms
 Delay before start-up ≤ 300ms

Electrical data

Operating voltage U_B 20 ... 250VAC, 50/60Hz
 20 ... 250VDC
 Power consumption ≤ 1.5VA
 Switching output ³⁾ relay, 1 change-over contact
 Function break-contact/make-contact
 Switching voltage, relay 250VAC/DC
 Switching current, relay 250VAC, 2.5A/30VDC, 2.5A
 Switching power, relay 625VA, $\cos\phi=1$
 Scanning range adjustable

Indicators

Green LED ready
 Yellow LED reflection

Mechanical data

Housing polycarbonate
 Optics cover plastic
 Weight 150g
 Connection type spring terminals, max. wire cross section 1.5mm²
 cable 2000mm, 5 x 0.5mm²

Environmental data

Ambient temp. (operation/storage) -40°C ... +60°C/-40°C ... +70°C
 Protective circuit ⁴⁾ 1, 4
 VDE safety class ⁵⁾ II, all-insulated
 Degree of protection IP 67, IP 69K ⁶⁾
 Light source exempt group (in acc. with EN 62471)
 Standards applied IEC 60947-5-2

Options

Switching function (teach level 1) light switching (factory setting) or dark switching
 Time module (teach level 2) active: dropout delay 500ms
 not active: no dropout delay (factory setting)

Optics heating

Current consumption approx. 70mA at 20VDC

- 1) Typ. scanning range limit: max. attainable range without performance reserve
- 2) Scanning range: recommended range with performance reserve
- 3) Suitable spark extinction (snubber) must be provided with inductive or capacitive loads.
- 4) 1=transient protection, 4=interference blanking
- 5) Rating voltage 250VAC
- 6) IP 69K test acc. to DIN 40050 part 9 simulated, high pressure cleaning conditions without the use of additives, acids and bases are not part of the test

Remarks

Operate in accordance with intended use.

- ☞ This product is not a safety sensor and is not intended as personnel protection.
- ☞ The product may only be put into operation by competent persons.
- ☞ Only use the product in accordance with the intended use.

- With the set scanning range, a tolerance of the upper scanning range limit is possible depending on the reflection properties of the material surface.

Tables

1	5	3000
2	20	2000
3	50	1500

1	white 90%
2	gray 18%
3	black 6%

Scanning range [mm]

Diagrams

HT49C... with red light

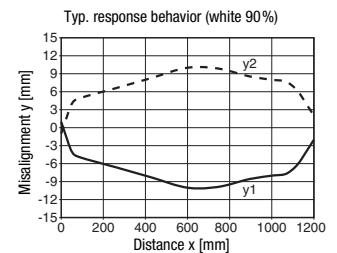

HT49CI... with infrared light

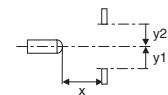
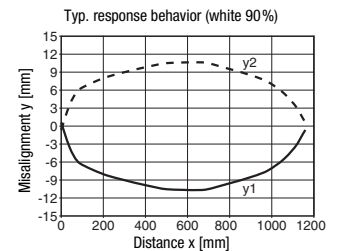

HT49C... with red light

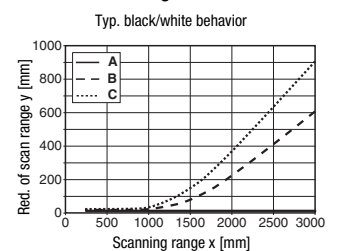

HT49CI... with infrared light

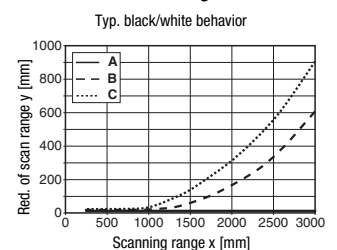

- A white 90%
- B gray 18%
- C black 6%

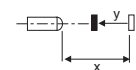

HT49C RELAIS Diffuse reflection light scanners with background suppression

Part number code

H T 4 9 C I . U C H / T S - T B

Operating principle

HT Diffuse reflection light scanners with background suppression

Series

49C 49C series

Light type

I Infrared light

free Red light

Operating voltage

UC 20 ... 250VAC/DC (all-mains design)

Equipment

H Optics heating

Setting

free Mechanical scanning range adjustment, teach button (light/dark switching, time module activation)

Switching output

TS Relay, normally closed contact/normally open contact (NC/NO)

M4 Low-impedance MOSFET semiconductor switching output, normally open contact (NO)

Connection technology

TB Terminal block - terminal compartment with spring terminals (5 x 1.5mm²)

free Cable 2000mm

Order guide

The sensors listed here are preferred types; current information at www.leuze.com.

All-mains designs with relay output

Designation

Part no.

Terminal compartment with spring terminals (5 x 1.5mm²)

Red light

HT49C.UC/TS-TB

50127193

Infrared light

HT49CI.UC/TS-TB

50127433

Red light, optics heating

HT49C.UCH/TS-TB

50130470

Infrared light, optics heating

HT49CI.UCH/TS-TB

50130471

Cable, cable length 2m

Red light

HT49C.UC/TS

50127430

Infrared light

HT49CI.UC/TS

50127434

Teach procedure for sensor



Note

Factory setting: **light switching, time module not active**

Light/dark switching

Setting the switching behavior of the relay output

Teach level 1	<p>Press teach button (2 to 7s) until both LEDs (green/yellow) flash synchronously. Release teach button – switchover is complete.</p> <p>The yellow LED then indicates the current setting of the switching output for 3s:</p> <p>ON = light switching = output between pin 4 and pin 3: normally closed contact (NC) output between pin 4 and pin 5: normally open contact (NO)</p> <p>OFF = dark switching = output between pin 4 and pin 3: normally open contact (NO) output between pin 4 and pin 5: normally closed contact (NC)</p>	<p>2 ... 7s</p> 
----------------------	---	---

Activation/deactivation of the time module

Setting a dropout delay for the relay output

Teach level 2	<p>Press teach button (7 to 12s) until both LEDs (green/yellow) flash alternately. Release teach button – activation/deactivation is complete.</p> <p>The yellow LED then indicates the current setting of the dropout delay for 3s:</p> <p>ON = time module not active = no dropout delay for the relay</p> <p>OFF = time module active = dropout delay for the relay: 500ms ¹⁾</p> <p><small>1) Additional models on request</small></p>	<p>7 ... 12s</p> 
----------------------	---	--

Dropout delay: if the object is no longer present, the output switches with a time delay.