



Figure can vary

**Part no.: 50137044**  
**HT3C/4X-M8**  
**Diffuse sensor with background suppression**



## Contents

- . Technical data
- . Dimensioned drawings
- . Electrical connection
- . Diagrams
- . Operation and display
- . Accessories
- . Notes



## Technical data

<b>Basic data</b>	
Series	3C
Operating principle	Scanning principle with background suppression

<b>Optical data</b>	
Black-white error	< 10% up to 220 mm
Operating range	Guaranteed operating range
Operating range, white 90%	0.005 ... 0.45 m
Operating range, gray 18%	0.01 ... 0.34 m
Operating range, black 6%	0.015 ... 0.22 m
Operating range limit	Typical operating range
Operating range limit	0.005 ... 0.45 m
Adjustment range	15 ... 450 mm
Beam profile	Focused
Light source	LED, Red
LED light wavelength	633 nm
Transmitted-signal shape	Pulsed
LED protection class	Exempt group (in acc. with EN 62471)
Type of light-spot geometry	Round
Focus	Fixed
Focal distance	200 mm

<b>Electrical data</b>	
Protective circuit	Short circuit protected Polarity reversal protection

<b>Performance data</b>	
Supply voltage	10 ... 30 V, DC, Incl. residual ripple
Residual ripple	0 ... 15 %, From $U_B$
Open-circuit current	0 ... 15 mA

<b>Outputs</b>	
Number of digital switching outputs	1 Piece(s)

<b>Switching outputs</b>	
Voltage type	DC
Switching current, max.	100 mA
Switching voltage	High: $\geq(U_B-2V)$ Low: $\leq 2V$

<b>Switching output 1</b>	
Assignment	Connection 1, pin 4
Switching element	Transistor, PNP
Switching principle	Light switching

<b>Timing</b>	
Switching frequency	1,000 Hz
Response time	0.5 ms
Readiness delay	300 ms
Response jitter	166 $\mu$ s

<b>Connection</b>	
-------------------	--

## Part no.: 50137044 – HT3C/4X-M8 – Diffuse sensor with background

### Connection 1

Type of connection	Connector
Function	Voltage supply Signal OUT
Thread size	M8
Type	Male
Material	Metal
No. of pins	4 -pin

### Mechanical data

Design	Cubic
Dimension (W x H x L)	11.4 mm x 34.2 mm x 18.3 mm
Housing material	Plastic, PC-ABS
Lens cover material	Plastic / PMMA
Net weight	10 g
Housing color	Red
Type of fastening	Via optional mounting device Through-hole mounting
Compatibility of materials	ECOLAB

### Operation and display

Type of display	LED
Number of LEDs	2 Piece(s)
Operational controls	Multiturn potentiometer
Function of the operational control	Scanning range adjustment

### Environmental data

Ambient temperature, operation	-40 ... 60 °C
Ambient temperature, storage	-40 ... 70 °C

### Certifications

Degree of protection	IP 69K IP 67
Protection class	III
Certifications	c UL US
Standards applied	IEC 60947-5-2

### Classification

eCl@ss 8.0	27270904
eCl@ss 9.0	27270904
ETIM 5.0	EC002719

## Dimensioned drawings

All dimensions in millimeters

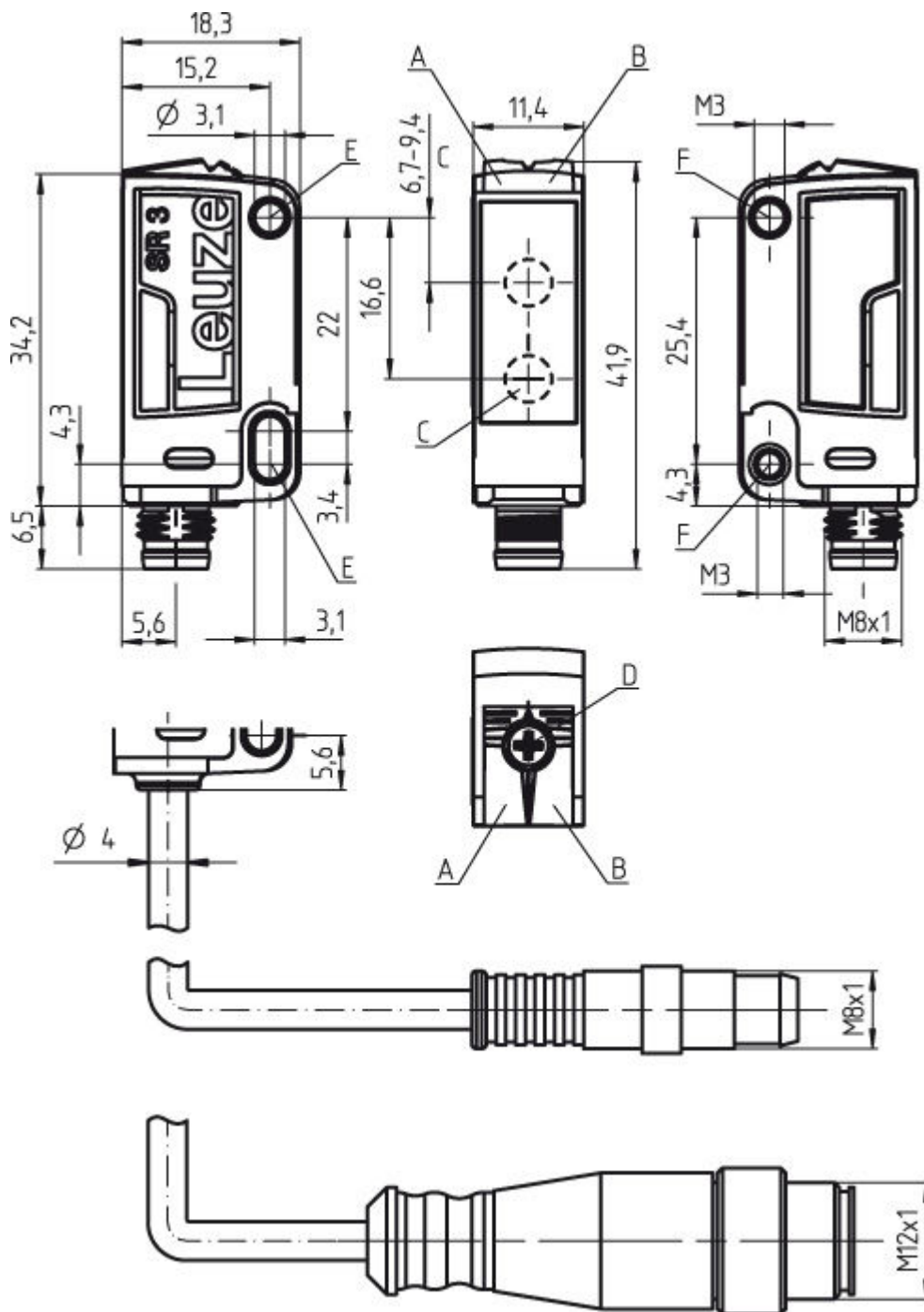

- A Green LED
- B Yellow LED
- C Optical axis
- D Multiturn potentiometer
- E Mounting sleeve (standard)
- F Threaded sleeve (3C.B series)

## Electrical connection

Connection 1	
Type of connection	Connector

Part no.: 50137044 – HT3C/4X-M8 – Diffuse sensor with background

Connection 1	
Function	Voltage supply Signal OUT
Thread size	M8
Type	Male
Material	Metal
No. of pins	4 -pin
Encoding	

Pin	Pin assignment
1	V+
2	n.c.
3	GND
4	OUT 1

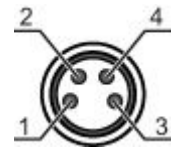

**Diagrams**

Typ. response behavior (white 90 %)

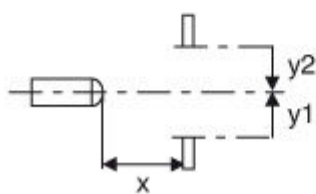
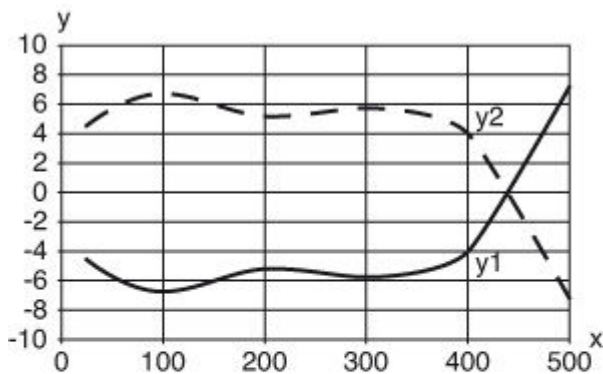

x Distance [mm]  
y Misalignment [mm]

Typ. black/white behavior

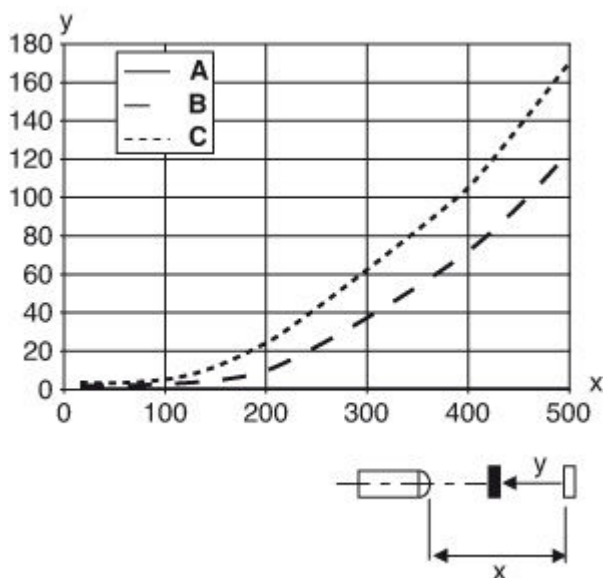

- x Range [mm]
- y Reduction of range [mm]
- A White 90%
- B Gray 18%
- C Black 6%

**Operation and display**

LEDs











LED	Display	Meaning
1	Green, continuous light	Ready
2	Yellow, continuous light	Object detected

**Accessories**



Connection technology - Connection cables

	Part no.	Designation	Article	Description
	50130854	KD U-M8-4A-P1-020	Connection cable	Connection 1: Connector, M8, Axial, Female, 4 -pin Connection 2: Open end Shielded: No Cable length: 2,000 mm Sheathing material: PUR
	50130855	KD U-M8-4A-P1-030	Connection cable	Connection 1: Connector, M8, Axial, Female, 4 -pin Connection 2: Open end Shielded: No Cable length: 3,000 mm Sheathing material: PUR

**Part no.: 50137044 – HT3C/4X-M8 – Diffuse sensor with background**

	Part no.	Designation	Article	Description
	50130856	KD U-M8-4A-P1-050	Connection cable	Connection 1: Connector, M8, Axial, Female, 4 -pin Connection 2: Open end Shielded: No Cable length: 5,000 mm Sheathing material: PUR
	50130857	KD U-M8-4A-P1-100	Connection cable	Connection 1: Connector, M8, Axial, Female, 4 -pin Connection 2: Open end Shielded: No Cable length: 10,000 mm Sheathing material: PUR
	50130858	KD U-M8-4A-P1-150	Connection cable	Connection 1: Connector, M8, Axial, Female, 4 -pin Connection 2: Open end Shielded: No Cable length: 15,000 mm Sheathing material: PUR
	50130859	KD U-M8-4A-P1-200	Connection cable	Connection 1: Connector, M8, Axial, Female, 4 -pin Connection 2: Open end Shielded: No Cable length: 20,000 mm Sheathing material: PUR
	50130848	KD U-M8-4A-V1-020	Connection cable	Connection 1: Connector, M8, Axial, Female, 4 -pin Connection 2: Open end Shielded: No Cable length: 2,000 mm Sheathing material: PVC
	50130849	KD U-M8-4A-V1-030	Connection cable	Connection 1: Connector, M8, Axial, Female, 4 -pin Connection 2: Open end Shielded: No Cable length: 3,000 mm Sheathing material: PVC
	50130850	KD U-M8-4A-V1-050	Connection cable	Connection 1: Connector, M8, Axial, Female, 4 -pin Connection 2: Open end Shielded: No Cable length: 5,000 mm Sheathing material: PVC
	50130851	KD U-M8-4A-V1-100	Connection cable	Connection 1: Connector, M8, Axial, Female, 4 -pin Connection 2: Open end Shielded: No Cable length: 10,000 mm Sheathing material: PVC
	50130852	KD U-M8-4A-V1-150	Connection cable	Connection 1: Connector, M8, Axial, Female, 4 -pin Connection 2: Open end Shielded: No Cable length: 15,000 mm Sheathing material: PVC
	50130853	KD U-M8-4A-V1-200	Connection cable	Connection 1: Connector, M8, Axial, Female, 4 -pin Connection 2: Open end Shielded: No Cable length: 20,000 mm Sheathing material: PVC

**Part no.: 50137044 – HT3C/4X-M8 – Diffuse sensor with background**



	Part no.	Designation	Article	Description
 	50130873	KD U-M8-4W-P1-020	Connection cable	Connection 1: Connector, M8, Angled, Female, 4 -pin Connection 2: Open end Shielded: No Cable length: 2,000 mm Sheathing material: PUR
 	50130880	KD U-M8-4W-P1-020-DP	Connection cable	Connection 1: Connector, M8, Angled, Female, 4 -pin Connector, LED: Yes, 1 Piece(s) Connection 2: Open end Shielded: No Cable length: 2,000 mm Sheathing material: PUR
 	50130874	KD U-M8-4W-P1-030	Connection cable	Connection 1: Connector, M8, Angled, Female, 4 -pin Connection 2: Open end Shielded: No Cable length: 3,000 mm Sheathing material: PUR
 	50130875	KD U-M8-4W-P1-050	Connection cable	Connection 1: Connector, M8, Angled, Female, 4 -pin Connection 2: Open end Shielded: No Cable length: 5,000 mm Sheathing material: PUR
 	50130881	KD U-M8-4W-P1-050-DP	Connection cable	Connection 1: Connector, M8, Angled, Female, 4 -pin Connector, LED: Yes, 1 Piece(s) Connection 2: Open end Shielded: No Cable length: 5,000 mm Sheathing material: PUR
 	50130876	KD U-M8-4W-P1-100	Connection cable	Connection 1: Connector, M8, Angled, Female, 4 -pin Connection 2: Open end Shielded: No Cable length: 10,000 mm Sheathing material: PUR
 	50130882	KD U-M8-4W-P1-100-DP	Connection cable	Connection 1: Connector, M8, Angled, Female, 4 -pin Connector, LED: Yes, 1 Piece(s) Connection 2: Open end Shielded: No Cable length: 10,000 mm Sheathing material: PUR
 	50130869	KD U-M8-4W-V1-020	Connection cable	Connection 1: Connector, M8, Angled, Female, 4 -pin Connection 2: Open end Shielded: No Cable length: 2,000 mm Sheathing material: PVC
 	50130877	KD U-M8-4W-V1-020-DP	Connection cable	Connection 1: Connector, M8, Angled, Female, 4 -pin Connector, LED: Yes, 1 Piece(s) Connection 2: Open end Shielded: No Cable length: 2,000 mm Sheathing material: PVC
 	50130870	KD U-M8-4W-V1-030	Connection cable	Connection 1: Connector, M8, Angled, Female, 4 -pin Connection 2: Open end Shielded: No Cable length: 3,000 mm Sheathing material: PVC

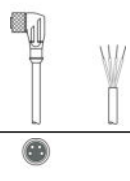
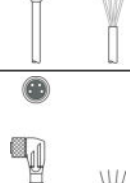
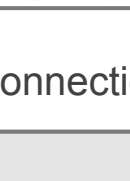

**Part no.: 50137044 – HT3C/4X-M8 – Diffuse sensor with background**



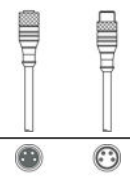
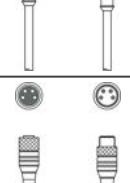

	Part no.	Designation	Article	Description
	50130871	KD U-M8-4W-V1-050	Connection cable	Connection 1: Connector, M8, Angled, Female, 4 -pin Connection 2: Open end Shielded: No Cable length: 5,000 mm Sheathing material: PVC
	50130878	KD U-M8-4W-V1-050-DP	Connection cable	Connection 1: Connector, M8, Angled, Female, 4 -pin Connector, LED: Yes, 1 Piece(s) Connection 2: Open end Shielded: No Cable length: 5,000 mm Sheathing material: PVC
	50130872	KD U-M8-4W-V1-100	Connection cable	Connection 1: Connector, M8, Angled, Female, 4 -pin Connection 2: Open end Shielded: No Cable length: 10,000 mm Sheathing material: PVC
	50130879	KD U-M8-4W-V1-100-DP	Connection cable	Connection 1: Connector, M8, Angled, Female, 4 -pin Connector, LED: Yes, 1 Piece(s) Connection 2: Open end Shielded: No Cable length: 10,000 mm Sheathing material: PVC

**Connection technology - Interconnection cables**





	Part no.	Designation	Article	Description
	50130913	KDS U-M8-4A-M8-4A-P1-003	Interconnection cable	Connection 1: Connector, M8, Axial, Female, 4 -pin Connection 2: Connector, M8, Axial, Male, 4 -pin Shielded: No Cable length: 300 mm Sheathing material: PUR
	50130914	KDS U-M8-4A-M8-4A-P1-006	Interconnection cable	Connection 1: Connector, M8, Axial, Female, 4 -pin Connection 2: Connector, M8, Axial, Male, 4 -pin Shielded: No Cable length: 600 mm Sheathing material: PUR
	50130915	KDS U-M8-4A-M8-4A-P1-010	Interconnection cable	Connection 1: Connector, M8, Axial, Female, 4 -pin Connection 2: Connector, M8, Axial, Male, 4 -pin Shielded: No Cable length: 1,000 mm Sheathing material: PUR
	50130916	KDS U-M8-4A-M8-4A-P1-020	Interconnection cable	Connection 1: Connector, M8, Axial, Female, 4 -pin Connection 2: Connector, M8, Axial, Male, 4 -pin Shielded: No Cable length: 2,000 mm Sheathing material: PUR

Part no.: 50137044 – HT3C/4X-M8 – Diffuse sensor with background

## Mounting technology - Mounting brackets

	Part no.	Designation	Article	Description
	50118542	BT 200M.5	Mounting bracket	Design of mounting device: Angle, L-shape Mounting bracket, at system: Through-hole mounting Mounting bracket, at device: Screw type Type of mounting device: Adjustable Material: Stainless steel
	50124651	BT 205M	Mounting device set	Contains: 10x Design of mounting device: Angle, L-shape Mounting bracket, at system: Through-hole mounting Mounting bracket, at device: Screw type Type of mounting device: Rigid Material: Metal
	50060511	BT 3	Mounting device	Design of mounting device: Angle, L-shape Mounting bracket, at system: Through-hole mounting Mounting bracket, at device: Screw type Type of mounting device: Rigid Material: Metal
	50105585	BT 3.1	Mounting strap set	Contains: 10x Design of mounting device: Retaining clip Mounting bracket, at system: Through-hole mounting Mounting bracket, at device: Screw type Type of mounting device: Rigid Material: Metal
	50105546	BT 3B	Mounting device	Design of mounting device: Angle, L-shape Mounting bracket, at system: Through-hole mounting Mounting bracket, at device: Screw type Type of mounting device: Rigid Material: Metal

## Mounting technology - Rod mounts

	Part no.	Designation	Article	Description
	50117256	BTU 200M-D10	Mounting system	Contains: 2x M3 x 18 screw, 2x position washers Design of mounting device: Mounting system Mounting bracket, at system: For 10 mm rod, Sheet-metal mounting Mounting bracket, at device: Screw type Type of mounting device: Clampable, Adjustable, Turning, 360° Material: Metal
	50117255	BTU 200M-D12	Mounting system	Contains: 2x M3 x 18 screw, 2x position washers Design of mounting device: Mounting system Mounting bracket, at system: For 12 mm rod, Sheet-metal mounting Mounting bracket, at device: Screw type Type of mounting device: Clampable, Adjustable, Turning, 360° Material: Metal
	50117254	BTU 200M-D14	Mounting system	Contains: 2x M3 x 18 screw, 2x position washers Design of mounting device: Mounting system Mounting bracket, at system: For 14 mm rod, Sheet-metal mounting Mounting bracket, at device: Screw type Type of mounting device: Clampable, Adjustable, Turning, 360° Material: Metal
	50120426	BTU 200M.5-D12	Mounting system	Contains: 2x M3 x 18 screw, 2x M3 mounting nut, 2x position washers Design of mounting device: Mounting system Mounting bracket, at system: For 12 mm rod Mounting bracket, at device: Screw type Type of mounting device: Turning, 360°, Clampable, Adjustable Material: Stainless steel

## Notes

### Observe intended use!

- This product is not a safety sensor and is not intended as personnel protection.
- The product may only be put into operation by competent persons.
- Only use the product in accordance with its intended use.

### For UL applications:

- For UL applications, use is only permitted in Class 2 circuits in accordance with the NEC (National Electric Code).
- These proximity switches shall be used with UL Listed Cable assemblies rated 30V, 0.5A min, in the field installation, or equivalent (categories: CYJV/CYJV7 or PVVA/PVVA7)

- Light source: Average life expectancy 100,000 h at an ambient temperature of 25 °C
- Response time: For short decay times, an ohmic load of approx. 5 kOhm is recommended
- Sum of the output currents for both outputs, 50 mA for ambient temperatures > 40 °C