

HRT 46B

Diffuse reflection light scanner with background suppression

en 06-2010/01 50107354-01



Dimensioned drawing

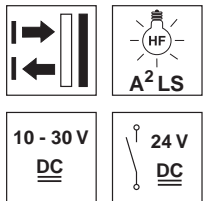
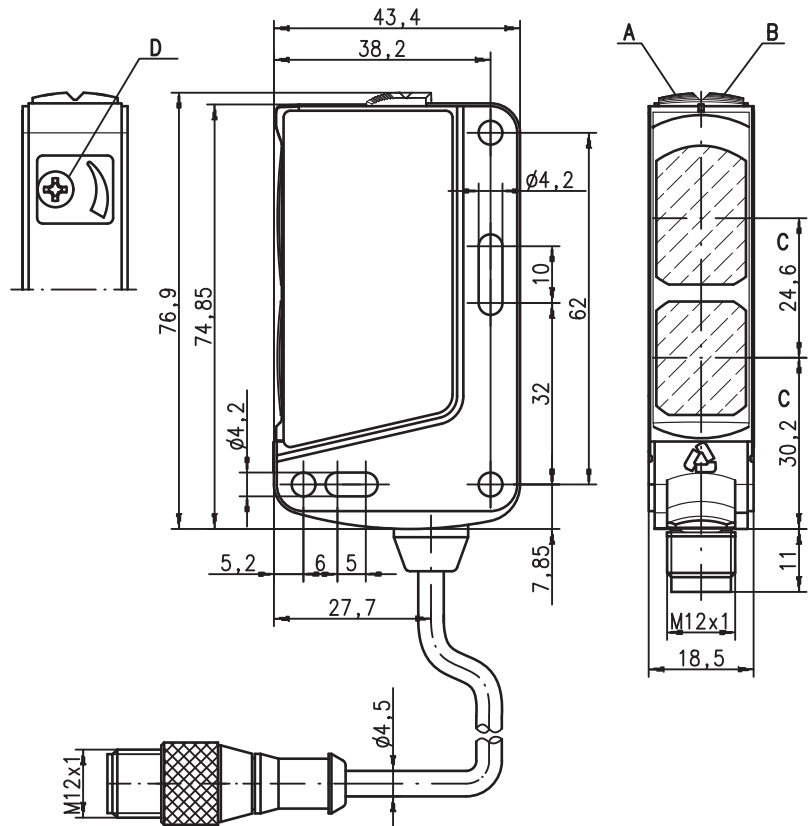

0 ... 2,500mm
1,200mm with
black-white error < 10%

- Adjustable scanner with background suppression
- Reliable detection of light and dark, as well as inclined or sloped surfaces
- Exact scanning range adjustment through multiturn potentiometer
- Complementary switching outputs for optimal adaptation to the application
- Warning output - for increased availability
- A²LS - Active Ambient Light Suppression

- A** Green indicator diode
- B** Yellow indicator diode
- C** Optical axis
- D** Scanning range adjustment

Electrical connection

Connector, 4-pin

U _B	1	br/BN
OUT*)	2	ws/WH
GND	3	bl/BU
OUT1	4	sw/BK

Cable

U _B	1	br/BN
OUT*)	2	ws/WH
GND	3	bl/BU
OUT1	4	sw/BK

Relay output

24V DC +/-10% +	1	br/BN
	2	ws/WH
GND	3	bl/BU
	4	sw/BK

Selection pin 2

*)	OUT
	OUT 2
	warn
	NC

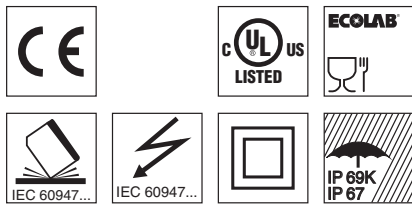

Accessories:

(available separately)

- Mounting systems (BT 46, BT 46.1, BT 46.1.5, BT 46.2)
- M12 connectors (KD ...)
- Ready-made cables (K-D ...)

We reserve the right to make changes • DS_HRT_46B_en.fm

Specifications

Optical data

Typ. scanning range limit (white 90%)¹⁾
 Scanning range²⁾
 Adjustment range
 Light source³⁾
 Wavelength

Infrared light

0 ... 2,500mm
 see tables
 120 ... 2,500mm
 LED (modulated light)
 850nm

Timing

Switching frequency
 Response time
 Delay before start-up

transistor: 200Hz, relay: 20Hz
 transistor: 2.5ms, relay: 25ms
 ≤ 100ms

Electrical data

With transistor switching outputs

Operating voltage U_B ⁴⁾ 10 ... 30VDC (incl. residual ripple)
 Residual ripple ≤ 15% of U_B
 Open-circuit current ≤ 30mA
 Switching output .../66. ... 2 push-pull switching outputs⁵⁾
 pin 2: PNP dark switching, NPN light switching
 pin 4: PNP light switching, NPN dark switching
 .../44. ... 2 PNP switching outputs
 pin 2: PNP dark switching, pin 4: PNP light switching
 .../4. ... PNP switching output, pin 4: PNP light switching
 .../4D. ... PNP switching output, pin 4: PNP dark switching
 $\geq (U_B - 2V) \leq 2V$
 max. 100mA

Signal voltage high/low
 Output current

With relay switching output

Operating voltage U_B ⁴⁾ 24VDC ± 10%
 Open-circuit current ≤ 40mA
 Switching output .../7. ... relay, make-contact between pin 2 and pin 4, light switching⁶⁾
 Switching voltage 30VAC/DC, max. 200mA
 Switching power max. 6VA, cos φ = 1

Indicators

Green LED ready
 Yellow LED reflection
 Yellow LED, flashing reflection, no performance reserve

Mechanical data

Housing / optics cover plastic / plastic
 Weight 50g (with connector) / 65g (with cable and conn.)
 Connection type M12 connector, or
 cable with M12 connector, cable length: 200mm

Environmental data

Ambient temp. (operation/storage) -40°C ... +60°C / -40°C ... +70°C
 Protective circuit⁷⁾ 2, 3
 VDE safety class⁸⁾ II, all-insulated
 Protection class IP 67, IP 69K
 LED class 1 (acc. to EN 60825-1)
 Standards applied IEC 60947-5-2

Options

Warning output autoControl warn PNP transistor, counting principle
 Signal voltage high/low $\geq (U_B - 2V) \leq 2V$
 Output current max. 100mA

- 1) Typ. scan. range limit: max. achievable scanning range for light objects (white 90%)
- 2) Scanning range: recommended scanning range for objects with different diffuse reflection
- 3) Average life expectancy 100,000 h at an ambient temperature of 25°C
- 4) For UL applications: for use in class 2 circuits only
- 5) The push-pull switching outputs must not be connected in parallel
- 6) Suitable spark extinction must be provided with inductive or capacitive loads
- 7) 2=polarity reversal protection, 3=short-circuit protection for all outputs
- 8) Rating voltage 50V

Tables

1	0	2,500
2	5	1,800
3	10	1,200

1	white 90%
2	grey 18%
3	black 6%

Scanning range [mm]

Diagrams

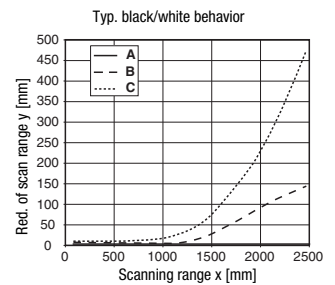
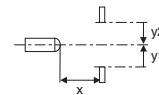
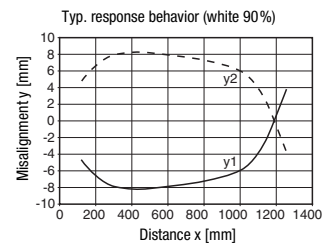

- A white 90%
- B grey 18%
- C black 6%

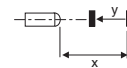

Remarks

- **Approved purpose:**
 This product may only be used by qualified personnel and must only be used for the approved purpose. This sensor is not a safety sensor and is not to be used for the protection of persons.
- With the set scanning range, a tolerance of the upper scanning range limit is possible depending on the reflection properties of the material surface.

HRT 46B

Diffuse reflection light scanner with background suppression

Order guide

The sensors listed here are preferred types; current information at www.leuze.com.

	Designation	Part No.
With M12 connector		
Complementary switching output	HRT 46B/66-S12	501 06547
Warning output, display low performance reserve	IHRT 46B/4-S12	501 06551
Warning output, display low performance reserve	IHRT 46B/4D-S12	501 06552
No contact with pin 2, direct connection to AS-interface I/O coupling modules possible	HRT 46B/4-S12	501 06549
No contact with pin 2, direct connection to AS-interface I/O coupling modules possible	HRT 46B/4D-S12	501 06550
Relay output, light switching	HRT 46B/7-S12	501 06562
Cable with M12 connector		
Complementary switching output	HRT 46B/66, 200-S12	501 06548

Type key

I	H	R	T		4	6	B	/	4	D	-	6	0	0	F	,	2	0	0	-	S	1	2
---	---	---	---	--	---	---	---	---	---	---	---	---	---	---	---	---	---	---	---	---	---	---	---

Operating principle	
HRT	Infrared-light scanner with background suppression
IHRT	Infrared-light scanner with background suppression and warning output
Series	
46B	46B Series
Switching output	
/66	Complementary push-pull switching outputs
/44	Complementary PNP switching outputs
/4	Pin 4 PNP switching output, pin 2 no contact or warning output
/6	Pin 4 push-pull switching output, pin 2 no contact
/7	Relay, make-contact
Function characteristics	
N/A	Pin 4 light switching; with push-pull, PNP light switching
D	Inverted switching logic
Special function	
.1	Detection of objects between the rollers of a roller conveyor
Product modifications	
-xxxx	Scanning range in mm, only for preset sensors (only on request)
F	Permanent setting (only on request)
Electrical connection	
N/A	Cable, standard length 2000 mm
,200-S12	Cable, length 200 mm with M12 connector
-S12	M12 connector

