



HRT 96

Diffuse reflection light scanner with background suppression



100 ... 1800mm
100 ... 1200mm



- Robust metal housing with glass cover, protection class IP 67/IP 69K for industrial application
- Access to all sensor functions via an AS-interface without additional wiring
- Scanning range adjustment and ready indicator for optimal adaptation to the application
- Common conductor for both power and data reduces installation work



Accessories:

(available separately)

- Mounting systems (BT 96, BT 96.1, UMS 96, BT 450.1-96)
- M12 connectors (KD ...)
- Ready-made cables (K-D ...)

AS-i Accessories:

(available separately)

- Bus terminals
- AS-i ribbon cable
- Address programming device
- Coupling modules
- Intermediate cables etc.

Dimensioned drawing

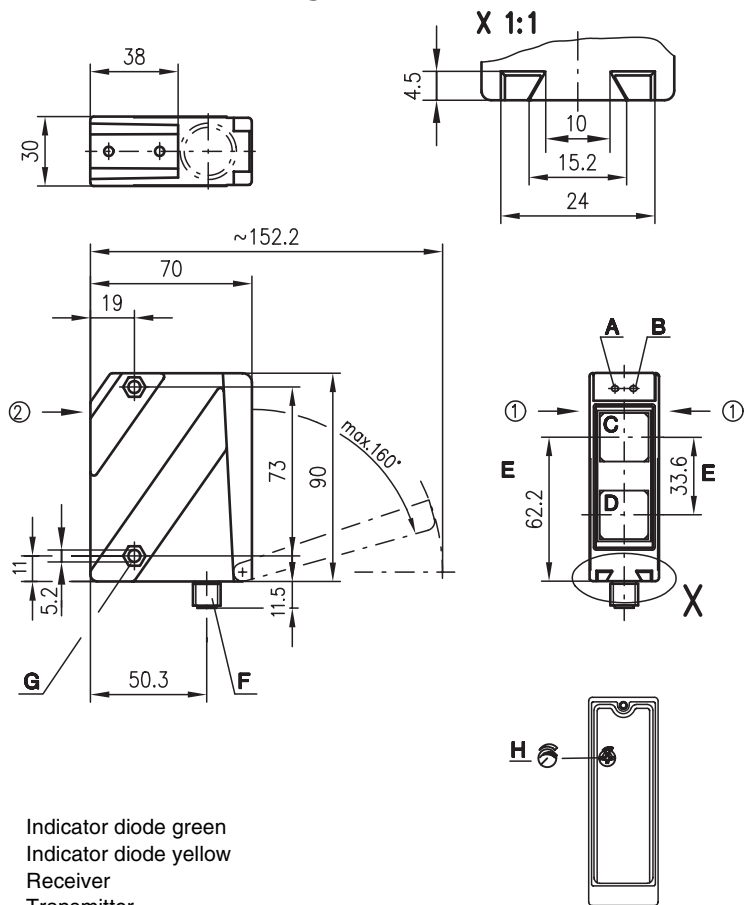

- A** Indicator diode green
 - B** Indicator diode yellow
 - C** Receiver
 - D** Transmitter
 - E** Optical axis
 - F** Device plug M12x1
 - G** Countersinking for SK nut M5, 4.2 deep
 - H** Scanning range adjustment
- Preferred entry direction for objects ① + ②

Electrical connection

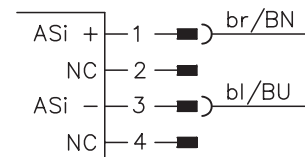

Specifications

Optical data

Typ. scanning range limit (white 90%) ¹⁾
 Scanning range ²⁾
 Adjustment range
 Light source
 Wavelength

Infrared

100 ... 1800mm
 see tables
 150 ... 1200mm
 LED (modulated light)
 880nm (infrared)

Red light

100 ... 1200mm
 see tables
 100 ... 800mm
 LED (modulated light)
 660nm

Timing

Sensor switching frequency 300Hz
 Sensor response time 1.67ms
 Delay before start-up ≤ 200ms

Electrical data

Operating voltage U_B 26.5 ... 31.6V (according to AS-i specification)
 Bias current ≤ 40mA per sensor

Indicators

LED green ready
 LED yellow reflection

Mechanical data

Housing diecast zinc
 Optics cover glass
 Weight 380g
 Connection type M12 connector

Environmental data

Ambient temp. (operation/storage) -20°C ... +60°C/-40°C ... +70°C
 Protective circuit ³⁾ 1, 4
 VDE safety class ⁴⁾ II, all-insulated
 Protection class IP 67, IP 69K ⁵⁾
 LED class 1 (acc. to EN 60825-1)
 Standards applied IEC 60947-5-2

AS-i data for receiver

I/O code 1
 ID code 1
 Address programmed by the user in the range of 1 to 31 (default=0)
 Cycle time acc. to AS-i specification 5ms
 AS-i standard according to profile S-1.1

- 1) Typ. scanning range limit: max. attainable range without performance reserve
- 2) Scanning range: recommended range with performance reserve
- 3) 1=transient protection, 4=interference blanking
- 4) Rating voltage 250VAC
- 5) IP 69K test acc. to DIN 40050 part 9 simulated, high pressure cleaning conditions without the use of additives, acids and bases are not part of the test

Assignment: data bits			Assignment: parameter bits			
		Programming (host level)			Programming (host level)	
D ₀	Switching output	0 no reflection 1 reflection	System input	*P ₀	NC 1	System parameter
D ₁	NC	0 1	System input	*P ₁	Light/dark switching 0 dark switching 1 light switching	System parameter
D ₂	Ready output	0 sensor not ready 1 sensor ready	System input	*P ₂	NC 0 1	System parameter
*D ₃	Activation input	0 transmitter on 1 transmitter off	System output	*P ₃	NC 0 1	System parameter

* default = 1

Remarks

- With the set scanning range, a tolerance of the upper scanning range limit is possible depending on the reflection properties of the material surface.

Order guide

	Designation	Part No.
Infrared light	HRT 96M/A-1660-1200-44	500 25112
Red light	HRT 96M/A-1670-800-44	500 80048

Tables

Red light

1	100	800	1200
2	100	770	1140
3	100	730	1050

Infrared light

1	100	1200	1800
2	100	1100	1600
3	100	1000	1350

1	white 90%
2	grey 18%
3	black 6%

- Scanning range [mm]
- Typ. scanning range limit [mm]

Diagrams

Red light

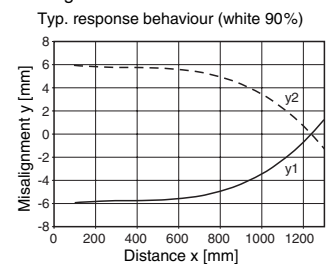

Infrared light

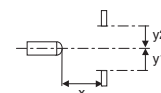
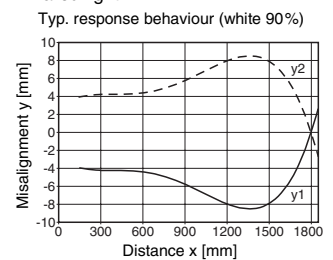

Red light

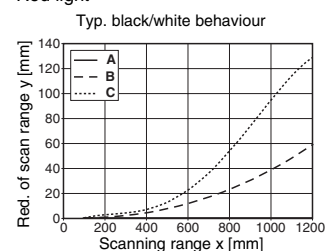

Infrared light

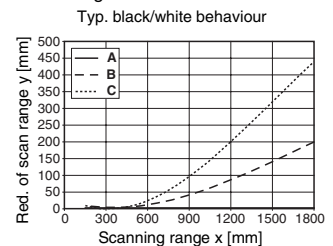

- A white 90%
 - B grey 18%
 - C black 6%
-