

HRT 96

Diffuse reflection light scanner with background suppression

en 01-2013/05 50123117



100 ... 1800 mm
100 ... 2000 mm



- Scanner with adjustable background suppression in infrared light
- Robust metal housing with glass cover or plastic housing, protection class IP 67 for industrial application
- Complementary outputs for standard applications and a wide range of input and output variants for optimum adaptation to the application
- Connection via M12 connector or terminal compartment
- Various options with switching delays, light/dark switching, activation input, and optics heating combined with low temperature

Dimensioned drawing

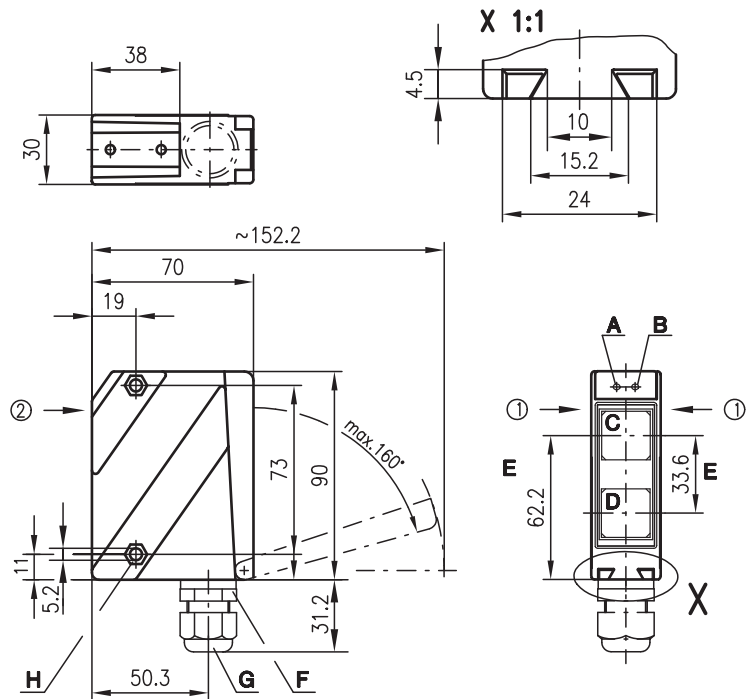

- A** Green indicator diode
 - B** Yellow indicator diode
 - C** Transmitter
 - D** Receiver
 - E** Optical axis
 - F** Device plug M12x1
 - G** Screwed cable gland M16x1.5 for Ø 5 ... 10mm
 - H** Countersinking for SK nut M5, 4.2 deep
 - I** Connection terminals
 - K** Cable entry
 - L** Scanning range adjustment
- Preferred entry direction for objects ① + ②

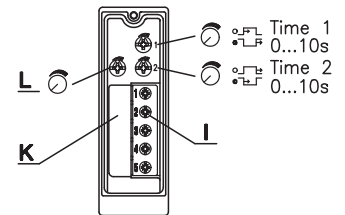

Electrical connection

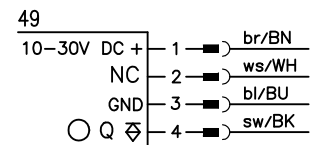
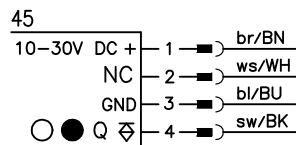
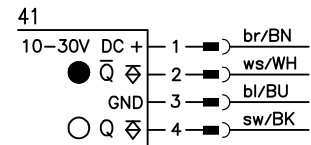
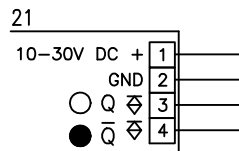

Accessories:

(available separately)

- Mounting systems (BT 96, BT 96.1, UMS 96, BT 450.1-96)
- M12 connectors (KD ...)
- Ready-made cables (K-D ...)

We reserve the right to make changes • DS_HRT96KP16xx_en_50123117.fm



Specifications

Optical data

Typ. scanning range limit (white 90%) ¹⁾
 Scanning range ²⁾
 Adjustment range
 Light source
 Wavelength

Infrared light

100 ... 1800mm
 see tables
 150 ... 1200mm
 LED (modulated light)
 880nm

Infrared light

100 ... 2000mm
 see tables
 150 ... 1800mm
 LED (modulated light)
 880nm

Timing

Switching frequency
 Response time
 Delay before start-up

300Hz
 1.67ms
 ≤ 200ms

Electrical data

Operating voltage U_B
 Residual ripple
 Open-circuit current
 Switching output
 Function
 Signal voltage high/low
 Output current

10 ... 30VDC (incl. residual ripple)
 ≤ 15% of U_B
 ≤ 35mA
 PNP transistor
 light or dark switching
 $\geq (U_B - 2V) \leq 2V$
 max. 100mA

Indicators

Green LED
 Yellow LED

ready
 reflection

Mechanical data

Housing
 Optics cover
 Weight
 Connection type

Plastic housing

polycarbonate
 plastic
 150g
 terminals or M12 connector

Metal housing

diecast zinc
 glass
 380g

Environmental data

Ambient temp. (operation/storage)
 Protective circuit ³⁾
 VDE safety class ⁴⁾
 Protection class
 Light source
 Standards applied

-30°C ... +60°C/-40°C ... +70°C
 1, 2, 3, 4
 II, all-insulated
 IP 67
 exempt group (in acc. with EN 62471)
 IEC 60947-5-2

Options

Switching delay (slow oper./release)
Activation input activ (high)
 Transmitter active/not active
 Activation/disable delay
Switching delay (slow oper./release)
Optics heating
Low temperature design

0 ... 10s (separately adjustable)
 $\geq 8V \leq 2V$
 $\leq 0.5ms$
 0 ... 10s (separately adjustable)
 for temperature changes, prevents fogging
 to -30°C

- 1) Typ. scanning range limit: max. attainable range without performance reserve
- 2) Scanning range: recommended range with performance reserve
- 3) 1=transient protection, 2=polarity reversal protection, 3=short circuit protection for all outputs, 4=interference blanking
- 4) Rating voltage 250VAC

Remarks

● Approved purpose

This product may only be used by qualified personnel and must only be used for the approved purpose. This sensor is not a safety sensor and is not to be used for the protection of persons.

- With the set scanning range, a tolerance of the upper scanning range limit is possible depending on the reflection properties of the material surface.
- The diffuse reflection light scanner is also available with integrated AS-i chip for direct connection to the AS-i system.
- Available as a set together with cable socket.

Tables

Infrared light 100 ... 1200mm

1	100	1200	1800
2	100	1100	1600
3	100	1000	1350

Infrared light 100 ... 1800mm

1	100	1800	2000
2	100	1700	1850
3	100	1500	1600

1	white 90%
2	gray 18%
3	black 6%

□ Scanning range [mm]
 □ Typ. scanning range limit [mm]

Diagrams

Infrared light 100 ... 1200mm

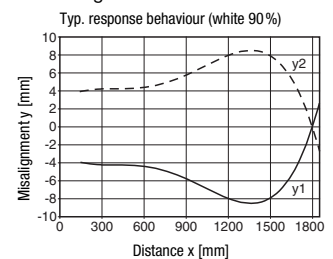

Infrared light 100 ... 1800mm

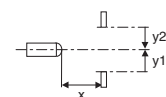
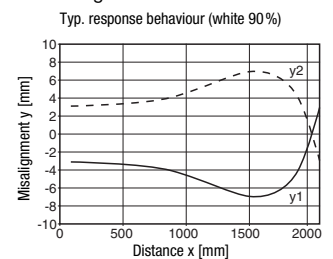

Infrared light 100 ... 1200mm

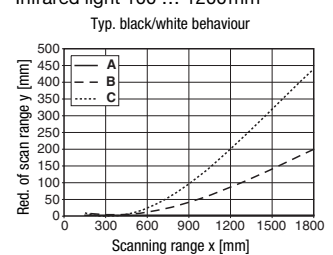

Infrared light 100 ... 1800mm

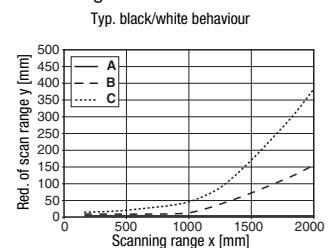

A white 90%
 B gray 18%
 C black 6%

HRT 96
Diffuse reflection light scanner with background suppression
Order guide

Selection table		Order code →							
Equipment ↓		HRT 96K/P-1600-1200-21 Part no. 50025135	HRT 96K/P-1600-1200-41 Part no. 50025133	HRT 96K/P-1607-1200-49 Part no. 50103090	HRT 96K/P-1600.1-1200-41 Part no. 50103217	HRT 96K/P-1600-1800-41 Part no. 50105667	HRT 96M/P-1620-1800-41 Part no. 50113909		
Light source	Infrared light (1200 mm)	●	●	●	●				
	Infrared light (1800 mm)					●	●		
Connection	Terminals	●							
	M12 connector		●	●	●	●	●		
Housing	Plastic	●	●	●	●	●			
	Metal						●		
Features	Switching delay								
	Activation input								
	PIN 2 = NC (for direct connection to AS-i I/O coupling modules)			●	●				
	PIN 4 = dark switching								
	PIN 4 = light switching			●					
	PIN 4 = light/dark reversible				●				
	Optics heating/low temperature design						●		
	UL approval	●	●	●	●	●	●		

