

FT5I

Reflection light scanner with fading

en 02-2015/09 50128293



Dimensioned drawing

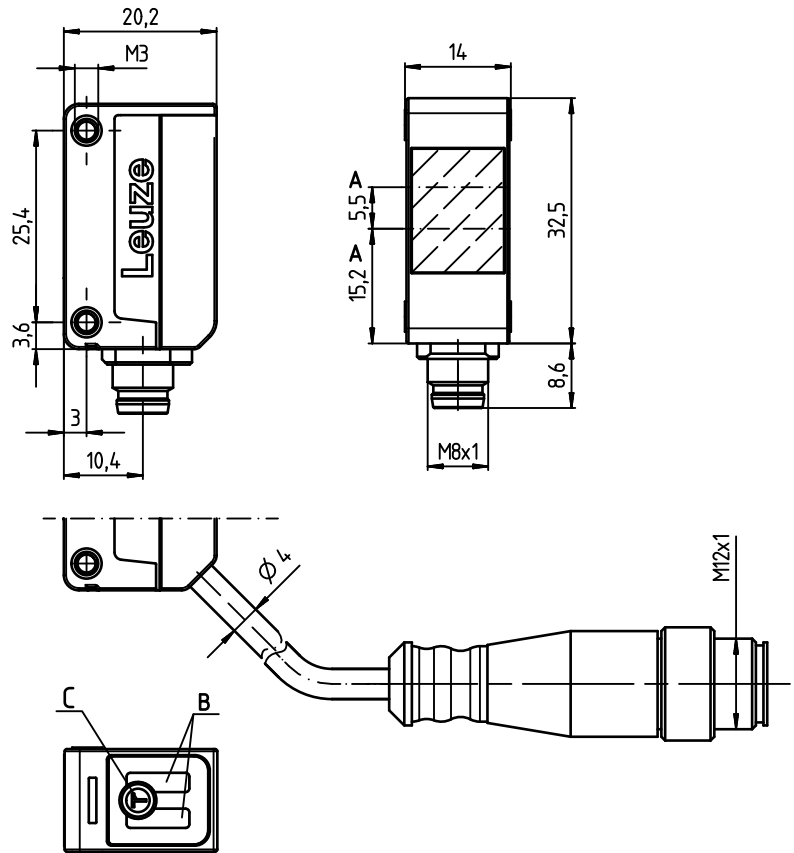

- A** Optical axis
- B** Indicator diodes
- C** Teach button

1 ... 280mm

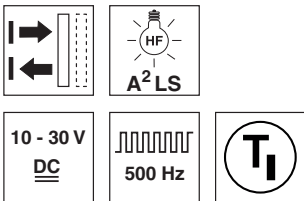

- Reflection light scanner with fading
- V-optics allow for reliable detection of dark objects in the short range
- Scanning range adjustment via teach-in
- Infrared light for universal use
- Active suppression of extraneous light A²LS
- Simple mounting with integrated M3 metal threaded sleeves
- Compact installation possible due to cable outlet at the rear or bottom
- Full control through green and yellow indicator LEDs
- Robust plastic housing acc. to IP 67 for industrial application

Electrical connection

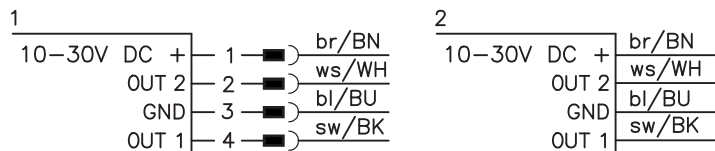

Accessories:

(available separately)

- Mounting systems (BTU 200 ..., BT 200..., BT 205M)
- M12 connectors (KD ...)
- Ready-made cables (K-D ...)

We reserve the right to make changes • DS_FT5I_en_50128293.fm



Specifications

Optical data

Scanning range limit ¹⁾	1 ... 280mm
Scanning range ²⁾	1 ... 215mm
Light source	LED (modulated light)
Wavelength	850nm (infrared light)

Timing

Switching frequency	500Hz
Response time	1ms
Delay before start-up	≤ 300ms

Electrical data

Operating voltage U_B ³⁾	10 ... 30VDC (incl. residual ripple)
Residual ripple	≤ 15% of U_B
Open-circuit current	≤ 20mA
Switching output	.../4P... 2 PNP transistor outputs pin 2: PNP dark switching, pin 4: PNP light switching .../2N... 2 NPN transistor outputs pin 2: NPN dark switching, pin 4: NPN light switching
Signal voltage high/low	≥ ($U_B - 2.5V$) / ≤ 2.5V
Output current	max. 100mA ⁴⁾

Indicators

Green LED	ready
Yellow LED	reflection (object detected)

Mechanical data

Housing	plastic
Optics cover	plastic
Weight	20g with M8 connector 70g with 2m cable
Connection type	M8 connector, 4-pin cable 2m, 4x0.20mm ²

Environmental data

Ambient temp. (operation/storage)	-40°C ... +60°C / -40°C ... +70°C
Protective circuit ⁵⁾	2, 3
VDE safety class	III
Degree of protection	IP 67
Light source	exempt group (in acc. with EN 62471)
Standards applied	IEC 60947-5-2
Certifications	UL 508, C22.2 No.14-13 ³⁾ ⁶⁾

- 1) Scanning range limit: typical scanning range
- 2) Scanning range: ensured scanning range
- 3) For UL applications: for use in class 2 circuits according to NEC only
- 4) Sum of the output currents for both outputs, 50mA when ambient temperatures > 40°C
- 5) 2=polarity reversal protection, 3=short circuit protection for all outputs
- 6) These proximity switches shall be used with UL Listed Cable assemblies rated 30V, 0.5A min, in the field installation, or equivalent (categories: CYJV/CYJV7 or PVVA/PVVA7)



Fading: black/white error < 50%

The black/white error is calculated from the scanning range against white and the reduction of the scanning range against black:

$$\text{Black/white error} = \frac{\text{Reduction of the scanning range against black}}{\text{Scanning range against white}} \times 100\%$$

Example:

Setting: "teach on object" at 160mm on white 90%

- Detection:

Black object, 6%, is detected at approx. 100mm, the black/white error here is:
60mm / 160mm = approx. 38%

Setting: "teach on object" at 120mm on black 6%

- Situation in background:

White object, 90%, is no longer detected at distance > 200mm, the black/white error here is: 80mm / 200mm = 40%

Tables

1	1	215	280
2	1	190	245
3	3	150	190
4	5	125	160

1	white 90%
2	gray 50%
3	gray 18%
4	black 6%

□	Scanning range [mm]
■	Typ. scanning range limit [mm]

Diagrams

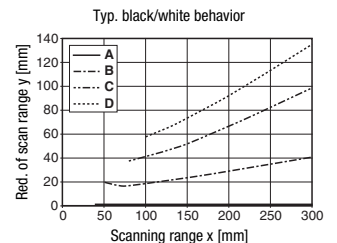

- A white 90%
- B gray 50%
- C gray 18%
- D black 6%

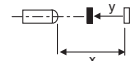

Remarks

Operate in accordance with intended use!

- ⚠ This product is not a safety sensor and is not intended as personnel protection.
- ⚠ The product may only be put into operation by competent persons.
- ⚠ Only use the product in accordance with the intended use.

- With the set scanning range, a tolerance of the scanning range limits is possible depending on the reflection properties of the material surface.

FT5I

Reflection light scanner with fading

Order guide

The sensors listed here are preferred types; current information at www.leuze.com.

		Designation	Part no.
With 4-pin M8 connector	Pin 4: PNP light switching, pin 2: PNP dark switching	FT5I.3/4P-M8	on request
	Pin 4: NPN light switching, pin 2: NPN dark switching	FT5I.3/2N-M8	on request
With cable, cable length 2m	Pin 4: PNP light switching, pin 2: PNP dark switching	FT5I.3/4P	50127904
	Pin 4: NPN light switching, pin 2: NPN dark switching	FT5I.3/2N	50127903

Part number code

		F	T	5	I	.	3	/	4	P	-	M	8
Operating principle													
FT	Diffuse reflection light scanners with fading												
Series													
5I	Series 5 wit infrared light												
Equipment													
.3	Axial optics, Teach-in via teach button												
Switching output/function /OUT1OUT2 (OUT1 = Pin 4, OUT2 = Pin 2)													
4	PNP, light switching												
P	PNP, dark switching												
2	NPN, light switching												
N	NPN, dark switching												
Electrical connection													
-M8	M8 connector, 4-pin												
N/A	Cable, standard length 2m												

Teach-in method

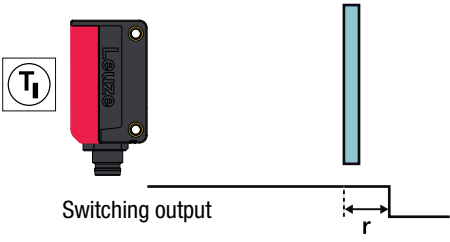
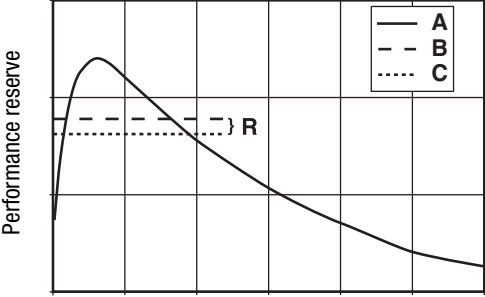
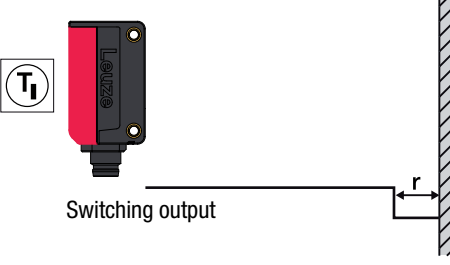
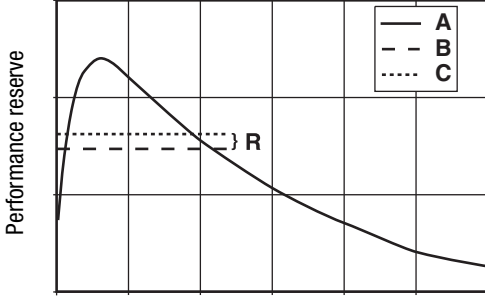
Teach	Operating level 1	Operating level 2
Standard Teach	<p>Teach on object:</p> <p>With this teach event, the object is located in front of the sensor. The switching threshold is set by the teach so that the object is detected with tight signal reserve R. Thus, the object is detected even if the distance increases by the value r with respect to the distance during the teach.</p>   <p>A Signal - object B Teach on object C Switching threshold</p>	<p>Teach on background:</p> <p>This teach is only suitable for applications with a fixed background. The teach is performed directly on the background without an object. The switching threshold is set to a value that is just above the background signal (signal reserve R). Thus, objects can be detected up to a distance of r in front of the background.</p>   <p>A Signal - background B Teach on background C Switching threshold</p>

FT5I

Reflection light scanner with fading

Operation via teach button

Teach in operating level 1

- Press teach button until both LEDs flash **simultaneously**.
- Release teach button.
- Ready.

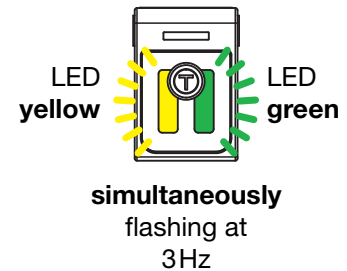
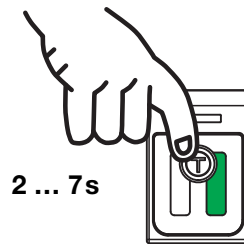

Teach in operating level 2

- Press teach button until both LEDs flash **alternatingly**.
- Release teach button.
- Ready.

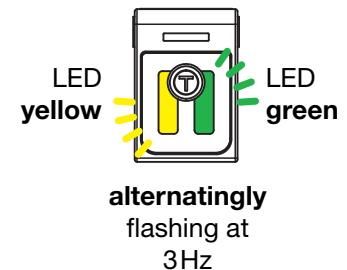
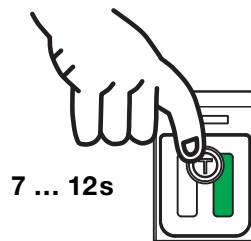

Adjusting the switching behavior of the switching output – light/dark switching

This function permits inversion of the sensors' switching logic.

- Press the teach button until only the green LED flashes. The yellow LED then shows the inverted switching logic:

- ON** = switching outputs light switching (in the case of complementary sensors, Q1 (pin 4) light switching, Q2 (pin 2) dark switching), this means output active when object is detected.
- OFF** = switching outputs dark switching (in the case of complementary sensors, Q1 (pin 4) dark switching, Q2 (pin 2) light switching), this means output inactive when object is detected.

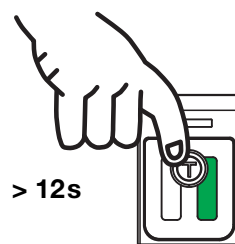

LED yellow
ON = light switching



LED green flashes with 3Hz

OFF = dark switching



- Release teach button.
- Ready.

