

FT328I X3

Reflection light scanner with intensified fading

Dimensioned drawing

en 01-2016/06 50134389

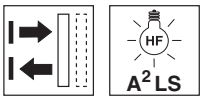

1 ... 130mm



- Reflection light scanner with intensified fading
- V-optics allow for reliable detection of dark objects in the short range
- Infrared light for universal use
- Active suppression of extraneous light A²LS
- Simple fine adjustment via *omni-mount*
- Embedded mounting option
- Full control through green and yellow indicator LEDs
- Sturdy plastic housing with stainless steel threaded sleeve with cylindrical M18x1 design

We reserve the right to make changes • DS_FT328I_X3_en_50134389.fm

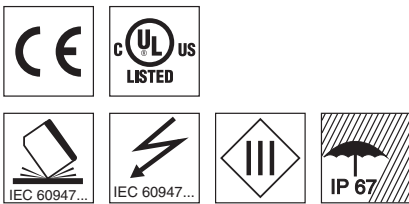

Accessories:

(available separately)

- Mounting systems (BT D18M.5, BT D21M, BT 318...)
- M12 connectors (KD ...)
- Ready-made cables (K-D ...)

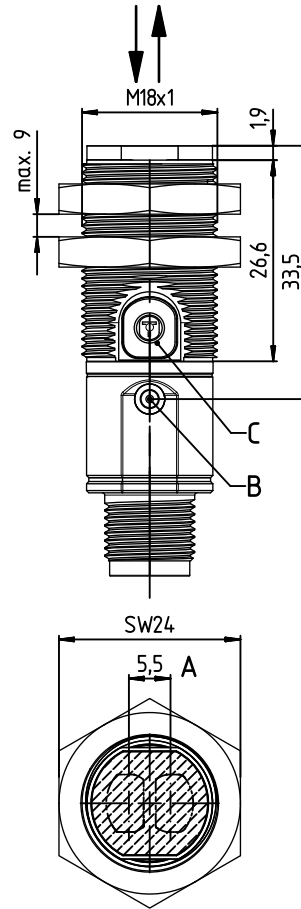

- A** Optical axes
- B** Indicator diode
- C** Teach button

Electrical connection

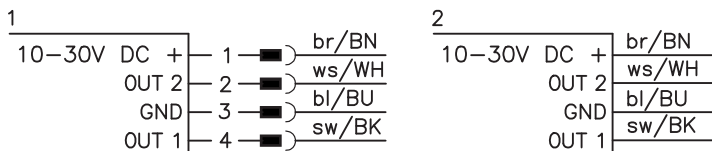

Specifications

Optical data

Scanning range limit ¹⁾	1 ... 130mm
Scanning range ²⁾	1 ... 110mm
Light source	LED (modulated light)
Wavelength	850nm (infrared light)

Timing

Switching frequency	500Hz
Response time	1ms
Delay before start-up	≤ 300ms

Electrical data

Operating voltage U_B ³⁾	10 ... 30VDC (incl. residual ripple)
Residual ripple	≤ 15% of U_B
Open-circuit current	≤ 20mA
Switching output	.../4P... 2 PNP transistor outputs pin 2: PNP dark switching, pin 4: PNP light switching .../2N... 2 NPN transistor outputs pin 2: NPN dark switching, pin 4: NPN light switching
Signal voltage high/low	≥ ($U_B - 2.5V$) / ≤ 2.5V
Output current	max. 100mA ⁴⁾

Indicators

Green LED	ready
Yellow LED	reflection (object detected)

Mechanical data

Housing	plastic
Optics cover	plastic
Weight	30g with M12 connector 80g with 2m cable M12 connector, 4-pin cable 2m, 4x0.20mm ²
Connection type	

Environmental data

Ambient temp. (operation/storage)	-40°C ... +60°C / -40°C ... +70°C
Protective circuit ⁵⁾	2, 3
VDE safety class	III
Degree of protection	IP 67
Light source	exempt group (in acc. with EN 62471)
Standards applied	IEC 60947-5-2
Certifications	UL 508, C22.2 No.14-13 ³⁾ ⁶⁾

- 1) Scanning range limit: typical scanning range
- 2) Scanning range: ensured scanning range
- 3) For UL applications: for use in class 2 circuits according to NEC only
- 4) Sum of the output currents for both outputs, 50mA when ambient temperatures > 40°C
- 5) 2=polarity reversal protection, 3=short circuit protection for all outputs
- 6) These proximity switches shall be used with UL Listed Cable assemblies rated 30V, 0.5A min, in the field installation, or equivalent (categories: CYJV/CYJV7 or PVVA/PVVA7)



Fading: black/white error < 50%

The black/white error is calculated from the scanning range against white and the reduction of the scanning range against black:

$$\text{Black/white-error} = \frac{\text{Reduction of the scanning range against black}}{\text{Scanning range against white}} \times 100\%$$

Example:

Setting: "teach on object" at 100mm on white 90%

- Detection:

Black object, 6%, is detected at approx. 65mm, the black/white error here is:
35mm / 100mm x 100% = 35%

Setting: "teach on object" at 50mm on black 6%

- Situation in background:

White object, 90%, is no longer detected at distance > 80mm, the black/white error here is:
30mm / 80mm x 100% = 37.5%

Tables

1	1	110	130
2	1	100	120
3	3	80	100
4	5	70	85

1	white 90%
2	gray 50%
3	gray 18%
4	black 6%

□	Scanning range [mm]
■	Typ. scanning range limit [mm]

Diagrams

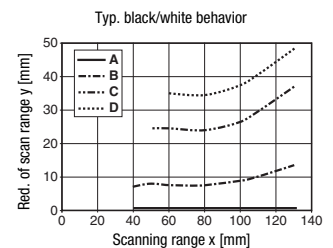

- A white 90%
- B gray 50%
- C gray 18%
- D black 6%

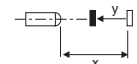

Remarks

Operate in accordance with intended use!

- ⚠ This product is not a safety sensor and is not intended as personnel protection.
- ⚠ The product may only be put into operation by competent persons.
- ⚠ Only use the product in accordance with the intended use.

- With the set scanning range, a tolerance of the scanning range limits is possible depending on the reflection properties of the material surface.

FT328I X3

Reflection light scanner with intensified fading

Order guide

The sensors listed here are preferred types; current information at www.leuze.com.

		Designation	Part no.
Sensors with axial optics			
With M12 connector	Pin 4: PNP light switching, pin 2: PNP dark switching	FT328I.X3/4P-M12	50133942
	Pin 4: NPN light switching, pin 2: NPN dark switching	FT328I.X3/2N-M12	50133941
With cable, 2m	Pin 4: PNP light switching, pin 2: PNP dark switching	FT328I.X3/4P	50133940
	Pin 4: NPN light switching, pin 2: NPN dark switching	FT328I.X3/2N	50133271
Accessories for optimum fastening			
	Mounting system <i>omni-mount</i>	BT318B-OM	50121904
	Mounting bracket for standard mounting	BT D18M.5	50113548
	Mounting bracket for <i>omni-mount</i>	BT D21M	50117257

Part number code

F T 3 2 8 I . X 3 / 4 P - M 1 2

Operating principle	
FT	Reflection light scanner with fading
Series	
328I	Series 328 with infrared light
Equipment	
X	Intensified fading
3	Axial optics, teach-in via teach button
Switching output/function /OUT1/OUT2 (OUT1 = Pin 4, OUT2 = Pin 2)	
4	PNP, light switching
P	PNP, dark switching
2	NPN, light switching
N	NPN, dark switching
Electrical connection	
-M12	M12 connector, 4-pin
N/A	Cable, standard length 2m

Teach-in method

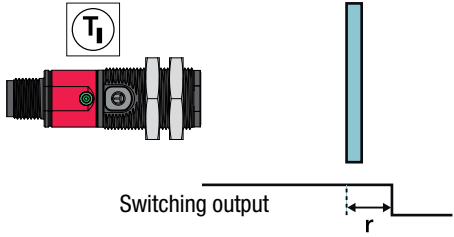
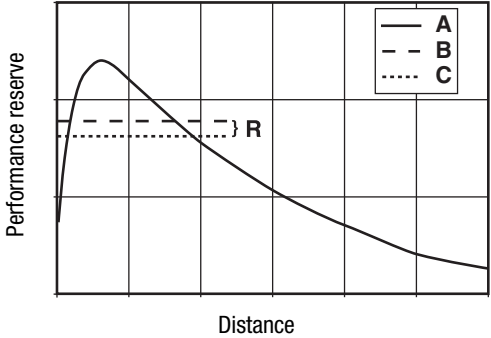
Teach	Operating level 1	Operating level 2
Standard Teach	<p>Teach on object:</p> <p>With this teach event, the object is located in front of the sensor. The switching threshold is set by the teach so that the object is detected with tight signal reserve R. Thus, the object is detected even if the distance increases by the value r with respect to the distance during the teach.</p>  <p>A Signal - object B Teach on object C Switching threshold</p>	<p>Teach on background:</p> <p>This teach is only suitable for applications with a fixed background. The teach is performed directly on the background without an object. The switching threshold is set to a value that is just above the background signal (signal reserve R). Thus, objects can be detected up to a distance of r in front of the background.</p>  <p>A Signal - background B Teach on background C Switching threshold</p>

FT328I X3

Reflection light scanner with intensified fading

Operation via teach button

Teach in operating level 1

- Press teach button until the **yellow** LED flashes.
- Release teach button.
- Ready.

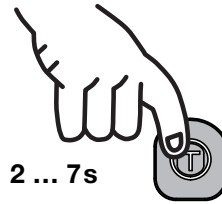

Teach in operating level 2

- Press teach button until **green** and **yellow** LEDs flash **alternately**.
- Release teach button.
- Ready.

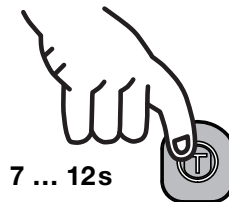

Adjusting the switching behavior of the switching output – light/dark switching

This function permits inversion of the sensors' switching logic.

- Press teach button until the **green** LED flashes.
- Release teach button.
- The LED then displays the changed switching logic for 2s:

YELLOW Cont. light = switching outputs **light switching** (in the case of complementary sensors, Q1 (pin 4) light switching, Q2 (pin 2) dark switching), this means output active when object is detected.

GREEN Flash. light = switching outputs **dark switching** (in the case of complementary sensors, Q1 (pin 4) dark switching, Q2 (pin 2) light switching), this means output inactive when object is detected.

- Ready.

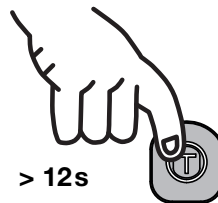

2s YELLOW = light switching

or



flashes GREEN for 2s = dark switching

