

## Datasheet

### DC-Operated Indicators with Steady or Pulsed Sound Indication

To view or download the latest technical information about this product, including specifications, dimensions, accessories, and wiring, see [www.bannerengineering.com](http://www.bannerengineering.com).



Figure 1. K50L



Figure 2. K80L

- Rugged, cost-effective, and easy-to-install indicators available in K50 or K80 housing style
- Steady or pulsed sound indication
- Illuminated dome provides a big, easy-to-see green, red or amber job light
- Compact devices are completely self-contained, no controller needed
- Choose NPN or PNP input, depending on model
- Immune to EMI and RFI interference
- 18 V dc to 30 V dc operation
- Three color LED function: green, red, and amber

#### WARNING: Not To Be Used for Personnel Protection

Never use this device as a sensing device for personnel **protection**. Doing so could lead to serious injury or death. This device does not include the self-checking redundant circuitry necessary to allow its use in personnel safety applications. A sensor failure or malfunction can cause either an energized or de-energized sensor output condition.



## Models

Model <sup>1</sup>	Construction	Audible Tone <sup>2</sup>	Input
K50LGRA1YPQ	50 mm dome/30 mm mount polycarbonate	Steady (75 dB)	PNP
K50LGRA1YNQ			NPN
K50LGRA2YPQ		Pulsed (75 dB)	PNP
K50LGRA2YNQ			NPN
K50LGRAL1YPQ		Loud Steady (95 dB)	PNP
K50LGRAL1YNQ			NPN
K80LGRA1YPQ	50 mm dome/Flat or DIN-mount polycarbonate, nylon	Steady (75 dB)	PNP
K80LGRA1YNQ			NPN
K80LGRA2YPQ		Pulsed (75 dB)	PNP
K80LGRA2YNQ			NPN
K80LGRAL1YPQ		Loud Steady (95 dB)	PNP
K80LGRAL1YNQ			NPN

<sup>1</sup> Integral quick disconnect models are listed.

- To order the 150 mm (6 in) PVC cable model, replace the suffix "Q" with "QP" in the model number. For example, K50LGRA1YPQP.
- K50L Models: To order the 2 m (6.5 ft) PVC cable model, omit the suffix "Q" in the model number. For example, K50LGRA1YP.
- K80L Models: To order the terminal-wired model, omit the suffix "Q" in the model number. For example, K80LGRA2YP.
- Models with a quick disconnect require a mating cordset.
- Contact Banner Engineering for other colors and color combinations.

<sup>2</sup> Typical decibel level is at a distance of 1 m.



# Wiring Diagrams

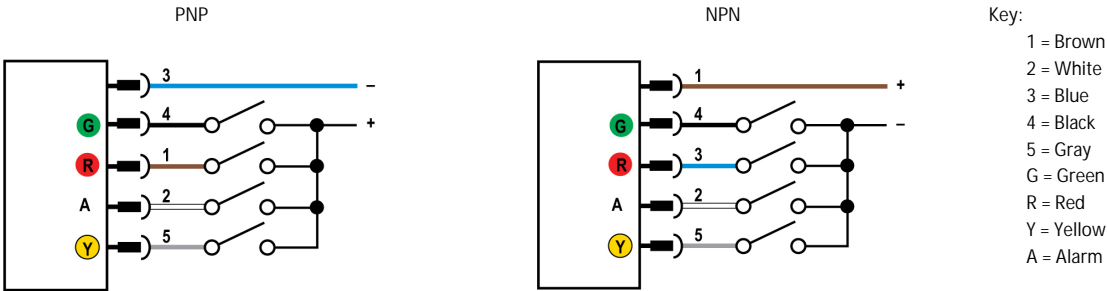

## Specifications

**Supply Voltage and Current**  
 18 V dc to 30 V dc at 40 mA maximum, per LED color (alarm)

**Input Response Time**  
 Indicator ON/OFF: 10 ms maximum

**Oscillation Frequency**  
 A1 models: 3 kHz ± 500 Hz  
 A2 models: 3 kHz ± 500 Hz; pulse rate 3 Hz ± 20%  
 AL1 models: 2.7 kHz ± 500 Hz

**Operating Conditions**  
 -20 °C to +50 °C (-4 °F to +122 °F)

**Environmental Rating**  
 IEC IP50  
 K50L models only: NEMA/UL Type 4X, 13

**Certifications**

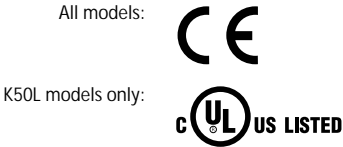

**Indicators**  
 LEDs or audible independently selected: green, red, amber

**Connections**  
 Integral 5-pin M12/Euro-style male quick disconnect (QD), or 150 mm (6 in) PVC cable with a 5-pin M12/Euro-style male quick disconnect (QD), or 2 m (6.5 ft) unterminated 5-wire PVC cable, depending on model  
 K80L Models: Terminal-wired models for use with bulk cable available

**Required Overcurrent Protection**

**WARNING:** Electrical connections must be made by qualified personnel in accordance with local and national electrical codes and regulations.

Overcurrent protection is required to be provided by end product application per the supplied table. Overcurrent protection may be provided with external fusing or via Current Limiting, Class 2 Power Supply. Supply wiring leads < 24 AWG shall not be spliced. For additional product support, go to [www.bannerengineering.com](http://www.bannerengineering.com).

Supply Wiring (AWG)	Required Overcurrent Protection (Amps)
20	5.0
22	3.0
24	2.0
26	1.0
28	0.8
30	0.5

## Dimensions

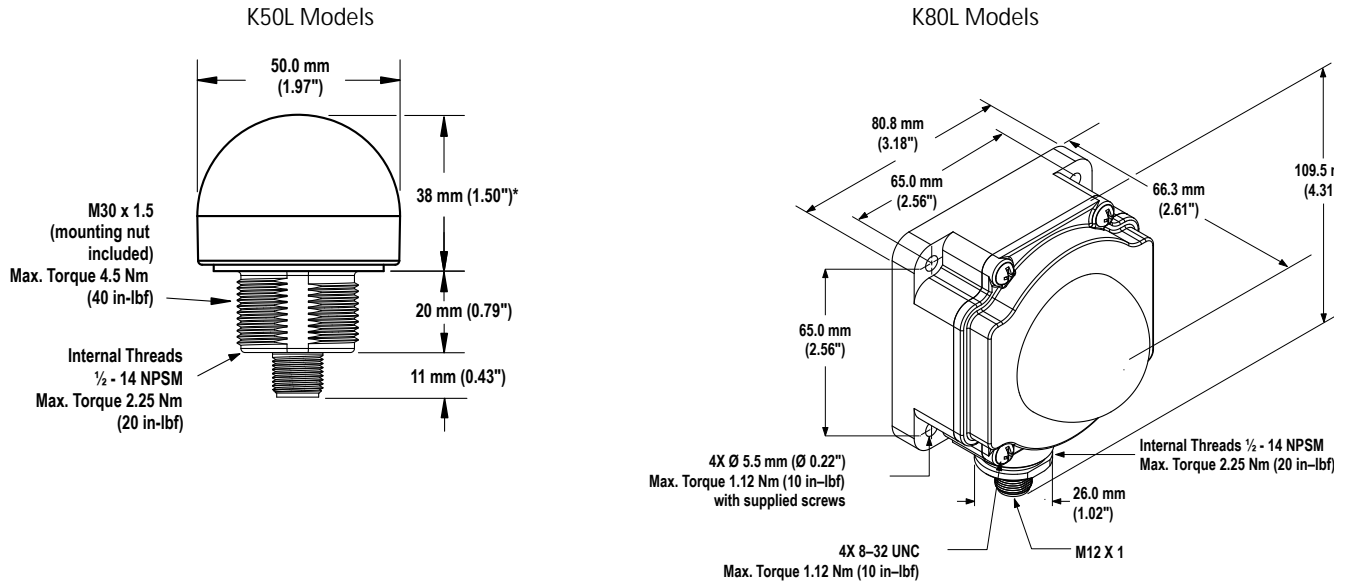

## Accessories

5-Pin Threaded M12/Euro-Style Cordsets—Single Ended				
Model	Length	Style	Dimensions	Pinout (Female)
MQDC1-501.5	0.50 m (1.5 ft)	Straight		 1 = Brown 2 = White 3 = Blue 4 = Black 5 = Gray
MQDC1-506	1.83 m (6 ft)			
MQDC1-515	4.57 m (15 ft)			
MQDC1-530	9.14 m (30 ft)			
MQDC1-506RA	1.83 m (6 ft)	Right-Angle		
MQDC1-515RA	4.57 m (15 ft)			
MQDC1-530RA	9.14 m (30 ft)			

### K80L Brackets

#### SMBDX80DIN

Black reinforced thermoplastic Bracket for mounting on a 35 mm DIN rail

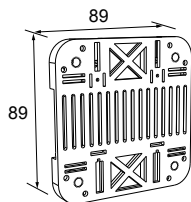

### K50L Brackets

**SMB30A**

- Right-angle bracket with curved slot for versatile orientation
- Clearance for M6 (¼ in) hardware
- Mounting hole for 30 mm sensor
- 12-ga. stainless steel

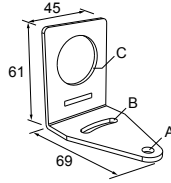

Hole center spacing: A to B=40  
Hole size: A=ø 6.3, B= 27.1 x 6.3, C=ø 30.5

**SMB30MM**

- 12-ga. stainless steel bracket with curved mounting slots for versatile orientation
- Clearance for M6 (¼ in) hardware
- Mounting hole for 30 mm sensor

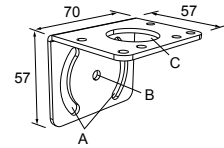

Hole center spacing: A = 51, A to B = 25.4  
Hole size: A = 42.6 x 7, B = ø 6.4, C = ø 30.1

**SMBAMS30RA**

- Right-angle SMBAMS series bracket
- 30 mm hole for mounting sensors
- Articulation slots for 90°+ rotation
- 12-ga. (2.6 mm) cold-rolled steel

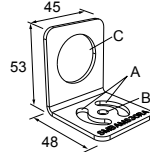

Hole center spacing: A=26.0, A to B=13.0  
Hole size: A=26.8 x 7.0, B=ø 6.5, C=ø 31.0

**SMB30SC**

- Swivel bracket with 30 mm mounting hole for sensor
- Black reinforced thermoplastic polyester
- Stainless steel mounting and swivel locking hardware included

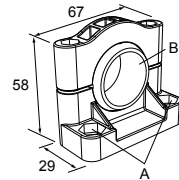

Hole center spacing: A=ø 50.8  
Hole size: A=ø 7.0, B=ø 30.0

**SMB30FA**

- Swivel bracket with tilt and pan movement for precise adjustment
- Mounting hole for 30 mm sensor
- 12-ga. 304 stainless steel
- Easy sensor mounting to extrude rail T-slot
- Metric and inch size bolt available

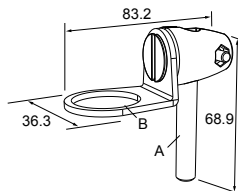

Bolt thread: SMB30FA, A= 3/8 - 16 x 2 in; SMB30FAM10, A= M10 - 1.5 x 50  
Hole size: B= ø 30.1

**SMBAMS30P**

- Flat SMBAMS series bracket
- 30 mm hole for mounting sensors
- Articulation slots for 90°+ rotation
- 12-ga. 300 series stainless steel

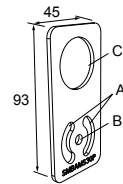

Hole center spacing: A=26.0, A to B=13.0  
Hole size: A=26.8 x 7.0, B=ø 6.5, C=ø 31.0

**SMB30FVK**

- V-clamp, flat bracket and fasteners for mounting to pipe or extrusions
- Clamp accommodates 28 mm dia. tubing or 1 in. square extrusions
- 30 mm hole for mounting sensors

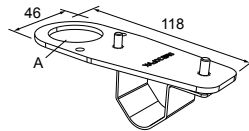

Hole size: A= ø 31

**SMB30RAVK**

- V-clamp, right-angle bracket and fasteners for mounting sensors to pipe or extrusion
- Clamp accommodates 28 mm dia. tubing or 1 in. square extrusions
- 30 mm hole for mounting sensors

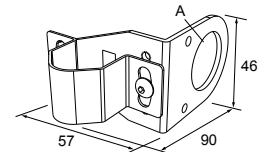

Hole size: A = ø 30.5

## Banner Engineering Corp. Limited Warranty

Banner Engineering Corp. warrants its products to be free from defects in material and workmanship for one year following the date of shipment. Banner Engineering Corp. will repair or replace, free of charge, any product of its manufacture which, at the time it is returned to the factory, is found to have been defective during the warranty period. This warranty does not cover damage or liability for misuse, abuse, or the improper application or installation of the Banner product.

THIS LIMITED WARRANTY IS EXCLUSIVE AND IN LIEU OF ALL OTHER WARRANTIES WHETHER EXPRESS OR IMPLIED (INCLUDING, WITHOUT LIMITATION, ANY WARRANTY OF MERCHANTABILITY OR FITNESS FOR A PARTICULAR PURPOSE), AND WHETHER ARISING UNDER COURSE OF PERFORMANCE, COURSE OF DEALING OR TRADE USAGE.

This Warranty is exclusive and limited to repair or, at the discretion of Banner Engineering Corp., replacement. IN NO EVENT SHALL BANNER ENGINEERING CORP. BE LIABLE TO BUYER OR ANY OTHER PERSON OR ENTITY FOR ANY EXTRA COSTS, EXPENSES, LOSSES, LOSS OF PROFITS, OR ANY INCIDENTAL, CONSEQUENTIAL OR SPECIAL DAMAGES RESULTING FROM ANY PRODUCT DEFECT OR FROM THE USE OR INABILITY TO USE THE PRODUCT, WHETHER ARISING IN CONTRACT OR WARRANTY, STATUTE, TORT, STRICT LIABILITY, NEGLIGENCE, OR OTHERWISE.

Banner Engineering Corp. reserves the right to change, modify or improve the design of the product without assuming any obligations or liabilities relating to any product previously manufactured by Banner Engineering Corp. Any misuse, abuse, or improper application or installation of this product or use of the product for personal protection applications when the product is identified as not intended for such purposes will void the product warranty. Any modifications to this product without prior express approval by Banner Engineering Corp will void the product warranties. All specifications published in this document are subject to change. Banner reserves the right to modify product specifications or update documentation at any time. Specifications and product information in English supersede that which is provided in any other language. For the most recent version of any documentation, refer to:

[www.bannerengineering.com](http://www.bannerengineering.com).