

RT 5

Energetic reflection light scanner

en 03-2015/09 50121955



Dimensioned drawing

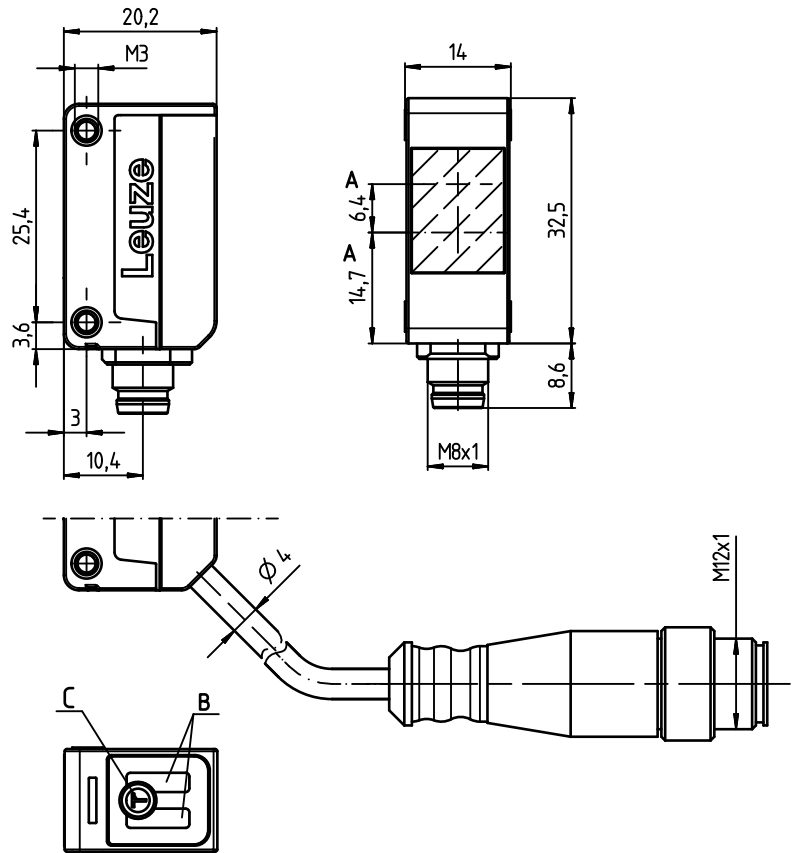

- A Optical axis
- B Indicator diodes
- C Teach button

1 ... 1000mm

HF A²LS

10 - 30 V DC 500 Hz T_I

- Energetic reflection light scanner
- Scanning range adjustment via teach-in
- Visible red light
- Active suppression of extraneous light A²LS
- Fast alignment through *brightVision*[®]
- Simple mounting with integrated M3 metal threaded sleeves
- Compact installation possible due to cable outlet at the rear or bottom
- Full control through green and yellow indicator LEDs
- Robust plastic housing acc. to IP 67 for industrial application

Electrical connection

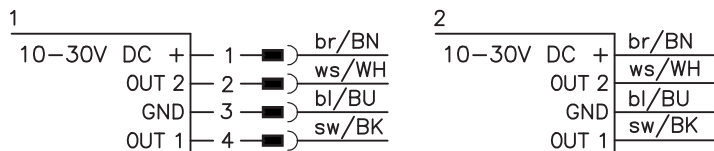

Accessories:

(available separately)

- Mounting systems (BTU 200 ..., BT 200..., BT 205M)
- M12 connectors (KD ...)
- Ready-made cables (K-D ...)

CE C UL US LISTED

IEC 60947... IEC 60947... III IP 67

We reserve the right to make changes • DS_ET5_en_50121955.fm

Specifications

Optical data

Scanning range limit ¹⁾	1 ... 1000mm
Scanning range ²⁾	see tables
Light source	LED (modulated light)
Wavelength	620nm (visible red light)

Timing

Switching frequency	500Hz
Response time	1ms
Delay before start-up	≤ 300ms

Electrical data

Operating voltage U_B ³⁾	10 ... 30VDC (incl. residual ripple)
Residual ripple	≤ 15% of U_B
Open-circuit current	≤ 20mA
Switching output	.../4P... 2 PNP transistor outputs pin 2: PNP dark switching, pin 4: PNP light switching .../2N... 2 NPN transistor outputs pin 2: NPN dark switching, pin 4: NPN light switching
Signal voltage high/low	≥ ($U_B - 2.5V$) / ≤ 2.5V
Output current	max. 100mA ⁴⁾

Indicators

Green LED	ready
Yellow LED	reflection (object detected)

Mechanical data

Housing	plastic
Optics cover	plastic
Weight	20g with M8 connector 40g with 200mm cable and M12 connector 70g with 2m cable
Connection type	M8 connector, 4-pin cable 200mm with M12 connector, 4-pin cable 2m, 4x0.20mm ²

Environmental data

Ambient temp. (operation/storage)	-40°C ... +60°C / -40°C ... +70°C
Protective circuit ⁵⁾	2, 3
VDE safety class	III
Degree of protection	IP 67
Light source	exempt group (in acc. with EN 62471)
Standards applied	IEC 60947-5-2
Certifications	UL 508, C22.2 No.14-13 ³⁾ ⁶⁾

- 1) Scanning range limit: typical scanning range
- 2) Scanning range: ensured scanning range
- 3) For UL applications: for use in class 2 circuits according to NEC only
- 4) Sum of the output currents for both outputs, 50mA when ambient temperatures > 40°C
- 5) 2=polarity reversal protection, 3=short circuit protection for all outputs
- 6) These proximity switches shall be used with UL Listed Cable assemblies rated 30V, 0.5A min, in the field installation, or equivalent (categories: CYJV/CYJV7 or PVVA/PVVA7)

Tables

1	1	700	1000
2	1	590	850
3	3	390	550
4	5	280	400

1	white 90%
2	gray 50%
3	gray 18%
4	black 6%

□	Scanning range [mm]
■	Typ. scanning range limit [mm]

Diagrams

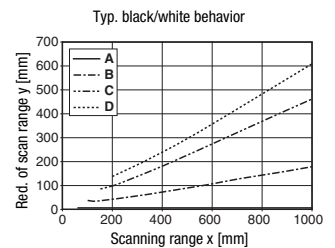

- A white 90%
- B gray 50%
- C gray 18%
- D black 6%

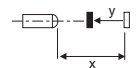

Remarks

Operate in accordance with intended use!

- ⚠ This product is not a safety sensor and is not intended as personnel protection.
- ⚠ The product may only be put into operation by competent persons.
- ⚠ Only use the product in accordance with the intended use.

- With the set scanning range, a tolerance of the scanning range limits is possible depending on the reflection properties of the material surface.

RT 5

Energetic reflection light scanner

Order guide

The sensors listed here are preferred types; current information at www.leuze.com.

		Designation	Part no.
With 4-pin M8 connector	Pin 4: PNP light switching, pin 2: PNP dark switching	ET5.3/4P-M8	50122578
	Pin 4: NPN light switching, pin 2: NPN dark switching	ET5.3/2N-M8	50122581
With 200mm cable and M12 connector	Pin 4: PNP light switching, pin 2: PNP dark switching	ET5.3/4P-200-M12	50122580
	Pin 4: NPN light switching, pin 2: NPN dark switching	ET5.3/2N-200-M12	50122583
With cable, cable length 2m	Pin 4: PNP light switching, pin 2: PNP dark switching	ET5.3/4P	50122579
	Pin 4: NPN light switching, pin 2: NPN dark switching	ET5.3/2N	50122582

Part number code

E T 5 . 3 / 4 P - 2 0 0 - M 1 2

Operating principle

ET Energetic reflection light scanner

Series

5 5 Series

Equipment

.3 Teach-in via teach button

Switching output/function /OUT1/OUT2 (OUT1 = Pin 4, OUT2 = Pin 2)

4 PNP, light switching

P PNP, dark switching

2 NPN, light switching

N NPN, dark switching

X Pin not used

Electrical connection

-M8 M8 connector, 4-pin

N/A Cable, standard length 2m

-200-M8 200mm cable with M8 connector

-200-M12 200mm cable with M12 connector

Teach-in method

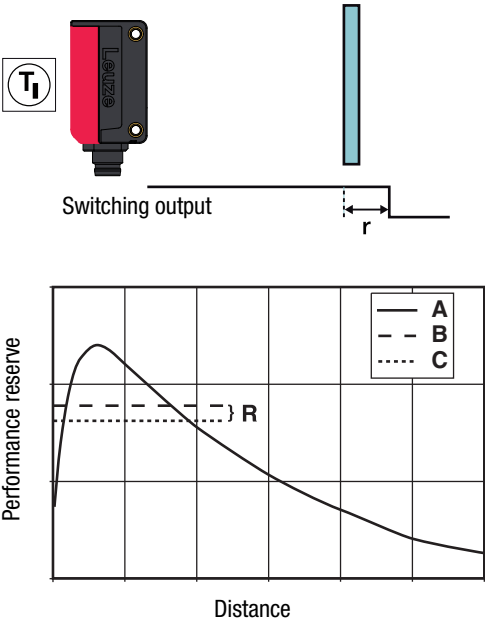
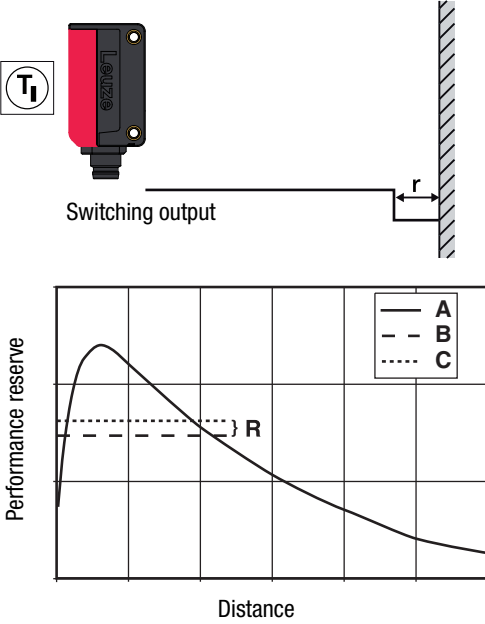
Teach	Operating level 1	Operating level 2
Standard Teach	<p>Teach on object:</p> <p>With this teach event, the object is located in front of the sensor. The switching threshold is set by the teach so that the object is detected with tight signal reserve R. Thus, the object is detected even if the distance increases by the value r with respect to the distance during the teach.</p>  <p>A Signal - object B Teach on object C Switching threshold</p>	<p>Teach on background:</p> <p>This teach is only suitable for applications with a fixed background. The teach is performed directly on the background without an object. The switching threshold is set to a value that is just above the background signal (signal reserve R). Thus, objects can be detected up to a distance of r in front of the background.</p>  <p>A Signal - background B Teach on background C Switching threshold</p>

RT 5

Energetic reflection light scanner

Operation via teach button

Teach in operating level 1

- Press teach button until both LEDs flash **simultaneously**.
- Release teach button.
- Ready.

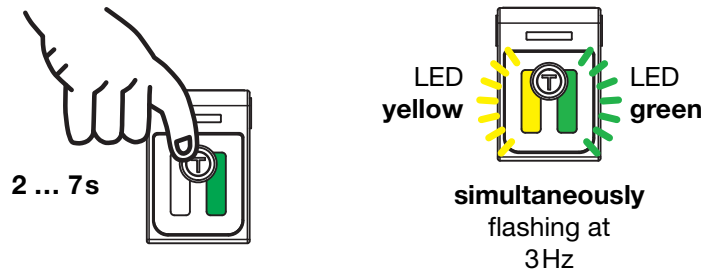

Teach in operating level 2

- Press teach button until both LEDs flash **alternatingly**.
- Release teach button.
- Ready.

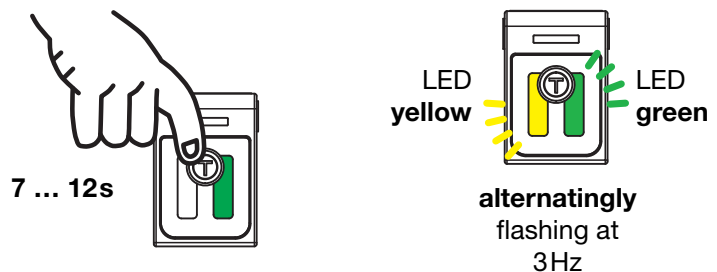

Adjusting the switching behavior of the switching output – light/dark switching

This function permits inversion of the sensors' switching logic.

- Press the teach button until only the green LED flashes. The yellow LED then shows the inverted switching logic:

ON = switching outputs light switching (in the case of complementary sensors, Q1 (pin 4) light switching, Q2 (pin 2) dark switching), this means output active when object is detected.

OFF = switching outputs dark switching (in the case of complementary sensors, Q1 (pin 4) dark switching, Q2 (pin 2) light switching), this means output inactive when object is detected.

- Release teach button.
- Ready.

