

ET318BI

Energetic diffuse reflection light scanners

Dimensioned drawing

en 03-2015/09 50127491

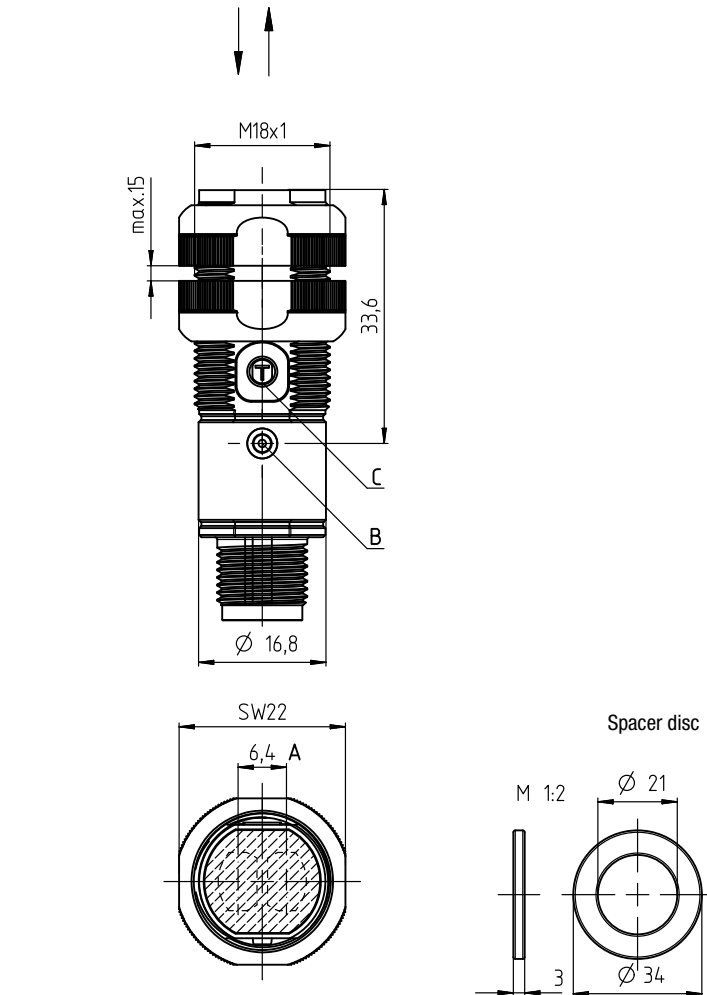

- A Optical axes
- B Indicator diode
- C Teach button

1 ... 1000mm

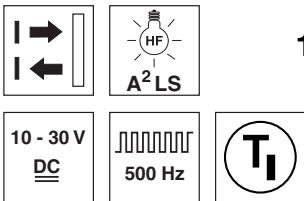

- Energetic diffuse reflection light scanner
- Scanning range adjustment via teach-in
- Infrared light for universal use
- Active suppression of extraneous light A²LS
- Simple fine adjustment via *omni-mount*
- Embedded mounting option
- Full control through green and yellow indicator LEDs
- Robust plastic housing acc. to IP 67 for industrial application

Electrical connection

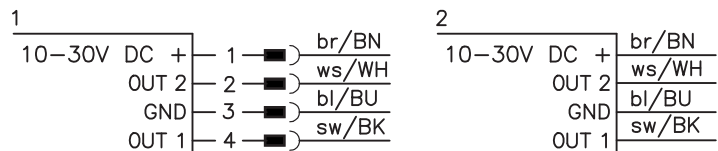

Accessories:

(available separately)

- Mounting systems (BT D18M.5, BT D21M, BT 318...)
- M12 connectors (KD ...)
- Ready-made cables (K-D ...)

We reserve the right to make changes • DS_ET318BI_en_50127491_fm



Specifications

Optical data

Scanning range limit ¹⁾	1 ... 1000mm
Scanning range ²⁾	1 ... 700mm
Light source	LED (modulated light)
Wavelength	850nm (infrared light)

Timing

Switching frequency	500Hz
Response time	1ms
Delay before start-up	≤ 300ms

Electrical data

Operating voltage U_B ³⁾	10 ... 30VDC (incl. residual ripple)
Residual ripple	≤ 15% of U_B
Open-circuit current	≤ 20mA
Switching output	.../4P... 2 PNP transistor outputs pin 2: PNP dark switching, pin 4: PNP light switching 2 NPN transistor outputs .../2N... pin 2: NPN dark switching, pin 4: NPN light switching
Signal voltage high/low	≥ ($U_B - 2.5V$) / ≤ 2.5V
Output current	max. 100mA ⁴⁾

Indicators

Green LED	ready
Yellow LED	reflection (object detected)

Mechanical data

Housing	plastic
Optics cover	plastic
Weight	20g with M12 connector 70g with 2m cable
Connection type	M12 connector, 4-pin cable 2m, 4x0.20mm ²

Environmental data



Ambient temp. (operation/storage)	-40°C ... +60°C / -40°C ... +70°C
Protective circuit ⁵⁾	2, 3
VDE safety class	III
Protection class	IP 67
Light source	exempt group (in acc. with EN 62471)
Standards applied	IEC 60947-5-2
Certifications	UL 508, C22.2 No.14-13 ³⁾ ⁶⁾

- 1) Scanning range limit: typical scanning range
- 2) Scanning range: ensured scanning range
- 3) For UL applications: for use in class 2 circuits according to NEC only
- 4) Sum of the output currents for both outputs, 50mA when ambient temperatures > 40°C
- 5) 2=polarity reversal protection, 3=short circuit protection for all outputs
- 6) These proximity switches shall be used with UL Listed Cable assemblies rated 30V, 0.5A min, in the field installation, or equivalent (categories: CYJV/CYJV7 or PVVA/PVVA7)

Tables

1	1	700	1000
2	1	590	850
3	3	390	550
4	5	280	400

1	white 90%
2	gray 50%
3	gray 18%
4	black 6%

	Scanning range [mm]
	Typ. scanning range limit [mm]

Diagrams

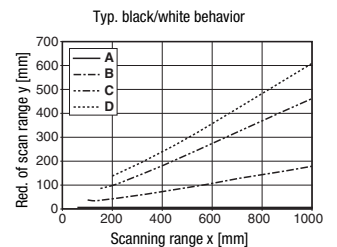

- A white 90%
- B gray 50%
- C gray 18%
- D black 6%

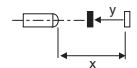

Remarks

Operate in accordance with intended use!

- ⚠ This product is not a safety sensor and is not intended as personnel protection.
- ⚠ The product may only be put into operation by competent persons.
- ⚠ Only use the product in accordance with the intended use.

- With the set scanning range, a tolerance of the scanning range limits is possible depending on the reflection properties of the material surface.

Mounting options

Standard mounting

Alignment of the supplied mounting nuts with flat side towards the mounting sheet.
Mounting bracket BT D18M.5 is recommended for standard mounting.

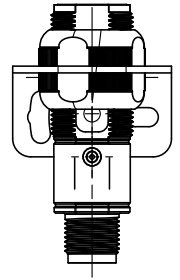

Omni-mount

Omni-mount makes fine adjustment of the sensors possible in a very simple and economical manner. For this type of mounting, the mounting nuts are used with the round side towards the mounting device. The mounting sheet must have a bore hole of approx. 21 mm in diameter. The special molding of the mounting nuts together with the spacer disc included in the delivery contents allows form-locking fastening of the sensors at different adjustment angles. The maximum possible tilt angle depends on the thickness of the mounting sheet. Mounting bracket BT D21M is recommended for *omni-mount*.

Mounting sheet thickness	Max. adjustment angle
2 mm	+/- 5°
4 mm ^{*)}	+/- 8°

^{*)} Corresponds to the thickness of the BT D21M mounting bracket

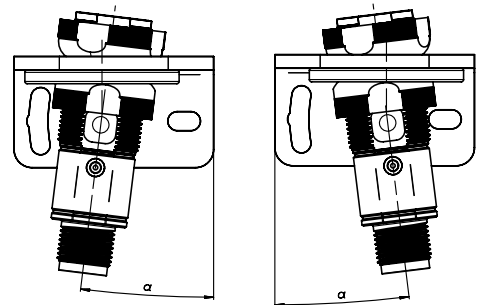

Embedded mounting

Embedded mounting, e.g. into a materials handling belt, is possible via the BT 318P-LS mounting support. The supports can be used either for fastening the axial sensors or for sensors with 90° optics.

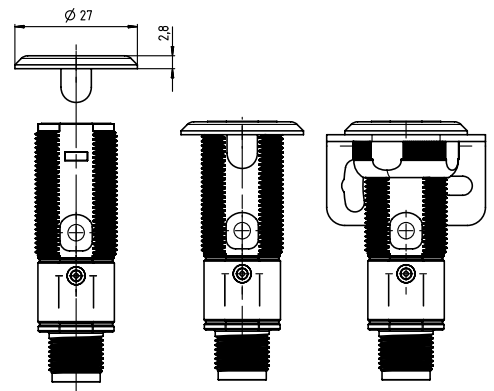

Order guide

The sensors listed here are preferred types; current information at www.leuze.com.

		Designation	Part no.
Sensors with axial optics			
With M12 connector	Pin 4: PNP light switching, pin 2: PNP dark switching	ET318BI.3/4P-M12	50127998
	Pin 4: NPN light switching, pin 2: NPN dark switching	ET318BI.3/2N-M12	50127999
With cable, 2m	Pin 4: PNP light switching, pin 2: PNP dark switching	ET318BI.3/4P	50126607
	Pin 4: NPN light switching, pin 2: NPN dark switching	ET318BI.3/2N	50126606
Accessories for optimum fastening			
Support for embedded mounting	Collective packaging with 10 supports	BT 318P-LS	50117258
Mounting bracket for standard mounting		BT D18M.5	50113548
Mounting bracket for <i>omni-mount</i>		BT D21M	50117257

Part number code

E	T	3	1	8	B	I	.	3	/	4	P	-	M	1	2
---	---	---	---	---	---	---	---	---	---	---	---	---	---	---	---

Operating principle	
ET	Energetic diffuse reflection light scanners
Series	
318BI	Series 318B wit infrared light
Equipment	
.3	Axial optics, Teach-in via teach button
Switching output/function /OUT1OUT2 (OUT1 = Pin 4, OUT2 = Pin 2)	
4	PNP, light switching
P	PNP, dark switching
2	NPN, light switching
N	NPN, dark switching
Electrical connection	
-M12	M12 connector, 4-pin
N/A	Cable, standard length 2m

Teach-in method

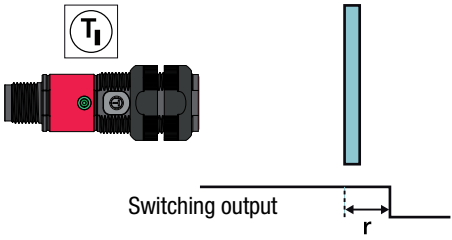
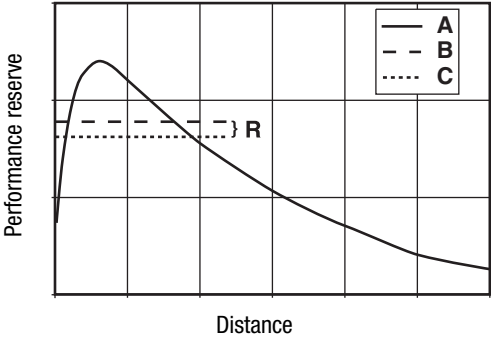
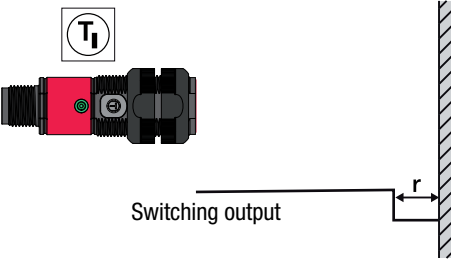
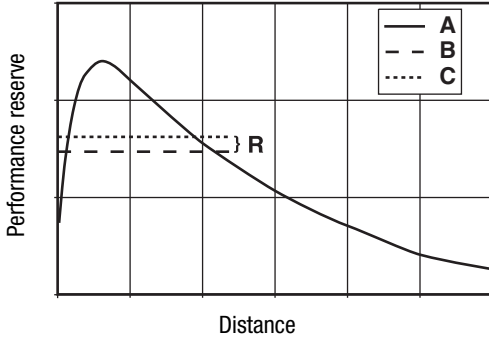
Teach	Operating level 1	Operating level 2
<p>Standard Teach</p>	<p>Teach on object:</p> <p>With this teach event, the object is located in front of the sensor. The switching threshold is set by the teach so that the object is detected with tight signal reserve R. Thus, the object is detected even if the distance increases by the value r with respect to the distance during the teach.</p>   <p>A Signal - object B Teach on object C Switching threshold</p>	<p>Teach on background:</p> <p>This teach is only suitable for applications with a fixed background. The teach is performed directly on the background without an object. The switching threshold is set to a value that is just above the background signal (signal reserve R). Thus, objects can be detected up to a distance of r in front of the background.</p>   <p>A Signal - background B Teach on background C Switching threshold</p>

Operation via teach button

Teach in operating level 1

- Press teach button until the **yellow** LED flashes.
- Release teach button.
- Ready.

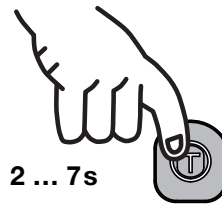

Teach in operating level 2

- Press teach button until green and yellow LEDs flash **alternately**.
- Release teach button.
- Ready.

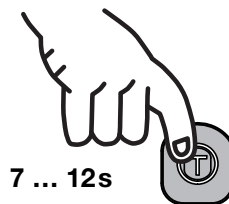

Adjusting the switching behavior of the switching output – light/dark switching

This function permits inversion of the sensors' switching logic.

- Press teach button until the **green** LED flashes.
- Release teach button.
- The LED then displays the changed switching logic for **2s**:

YELLOW	= switching outputs light switching
Continuous light	(in the case of complementary sensors, Q1 (pin 4) light switching, Q2 (pin 2) dark switching), this means output active when object is detected.
GREEN	= switching outputs dark switching
Flashing light	(in the case of complementary sensors, Q1 (pin 4) dark switching, Q2 (pin 2) light switching), this means output inactive when object is detected.

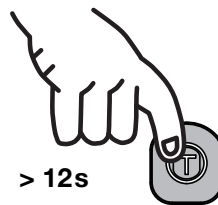

2s YELLOW = light switching

or



flashes **GREEN** for 2s = **dark switching**

- Ready.