

E-Series Analog or Start/Stop

Temposonics® EP and EL
Stroke length 50...3000 mm
depends on output

Document Part Number
551245 Revision F



- Linear, absolute measurement
- Contactless sensing with highest durability
- Rugged industrial sensor
- EMC tested and marked with CE
- Linearity deviation less than 0.02 % F.S.
- Repeatability less than 0.005 % F.S.
- Direct signal output for position:
 - Analog (V/mA)
 - Start/Stop + sensor-parameter upload
- Stroke length 50...3000 mm depends on output

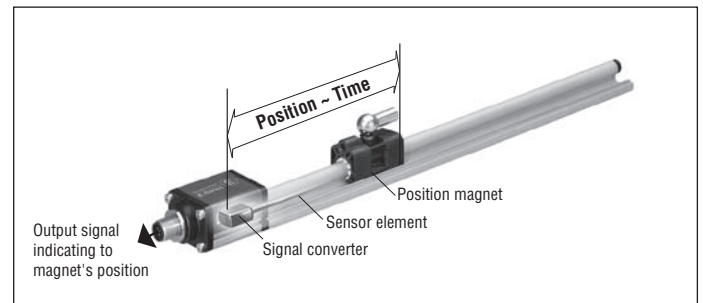

Magnetostriction

The Temposonics® linear position transducers are based on magnetostriction technology. Magnetostriction is a ferromagnetic material phenomenon which relates a dimensional change of the material to its magnetization properties. It is the product of a general coupling between the magnetic and elastic transport properties of the materials crystal lattice. This affect is typically on the scale of a few parts per million. It is quasi linear with the material's magnetization, may be positive or negative, and reaches a maximum at magnetic saturation. It is reversible, but exhibits a hysteric affect if the magnetization does so. Magnetostriction was characterized in the late 19th century, the longitudinal version is called the „Joule“ effect, the torsional version is called the „Wiedemann“ effect, and the reciprocal effect where mechanical stress changes the magnetic properties is referred to as the „Villari“ effect.

Design

Temposonics® are extremely robust sensors, ideal for continuous operation under harshest industrial conditions.

- A profile sensor housing protects the sensor element in which gives rise to the measurement signal.
- The sensor head, a solid diecast aluminum housing, accommodates the complete electronic interface with active signal conditioning.
- The external position transmitter is fitted at the mobile machine part, taken over the sensing.

Temposonics® EP and EL

Mechanically robust profile-style housing

Stroke length: 50...2500 mm (output analog)
50...3000 mm (output start/stop)

A robust aluminum profile offers modular construction, flexible mounting configurations and easy installation. Position measurement is contactless via two versions of position magnets.

1. A captive sliding position magnet running in profile housing rails. Connection with the mobile machine part is via a ball jointed arm to taking up axial forces.
2. A floating position magnet, mounted directly on the moving machine part, travels over the profile at a low distance. Its permissible misalignment allows a not completely parallel installation.

Technical data

Input

Measured variable	position
Stroke length	50...2500 mm / 50...3000 mm for output start/stop

Output

1. Voltage	0...10 VDC or 10...0 VDC, 0...10 VDC and 10...0 VDC (controller input resistance RL: > 5 kOhms)
2. Current	4...20 mA or 20...4 mA, (min./max. load: 0/500 Ohms)
3. Start/Stop	RS-422 differential signal additionally available: serial parameter upload of stroke length, offset, gradient, status and manufacturer number

Accuracy

Resolution	analog: infinite start/stop: 0.1 / 0.01 / 0.005 mm
Linearity ¹	≤ ± 0.02 % F.S. (minimum ± 60 μm)
Repeatability	≤ ± 0.005 % F.S. (minimum ± 20 μm)
Update frequency, stroke dependent	analog: < 3 kHz / start/stop: controller dependent
Ripple	analog: ≤ 0.01 % F.S. / start/stop: controller dependent

Operating condition

Mounting position	any
Magnet speed	any
Operating temperature	-40 °C...+75 °C
Dew point, humidity	90 % rel. humidity, no condensation
Electronic ingress protection ²	IP67 if mating cable connector is correctly fitted
Shock rating	100 g (single shock) / IEC-Standard 60068-2-27
Vibration test	15 g / 10...2000 Hz IEC-Standard 60068-2-6 (resonance frequencies excluded)
EMC test	Electromagnetic Emission EN 61000-6-4 (for use in industrial environment) Electromagnetic Susceptibility EN 61000-6-2 The sensor meets the requirements of the EC directives and is marked with CE.

Design/Material

Sensor head	aluminum
Sensor housing	aluminum
Position magnet	see chapter position magnets

Installation

Mounting type	adjustable mounting clamps
---------------	----------------------------

Electrical connection

Connection type	5 pin connector M12 (analog); 8 pin connector M12 (start/stop)
Supply voltage	24 VDC (-15 % / +20 %); UL Recognition requires an approved power supply with energy limitation (UL 61010-1), or Class 2 rating according to the National Electrical Code (USA) / Canadian Electrical Code.
Current consumption	50...140 mA (start/stop 50...100 mA)
Ripple	≤ 0.28 Vpp
Electric strength	500 VDC (DC ground to machine ground)
Polarity protection	up to -30 VDC
Overvoltage protection	up to 36 VDC

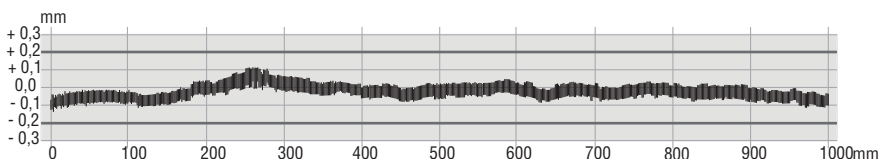

Linearity protocol

Sensor Temposonics® EP/EL, measuring range 1000 mm
Tolerance allowed: ± 0.2 mm
Tolerance measured: typical ± 0.09 mm

¹ with position magnet # 252 182.

² The IP rating is not part of the UL recognition

Temposonics® EP

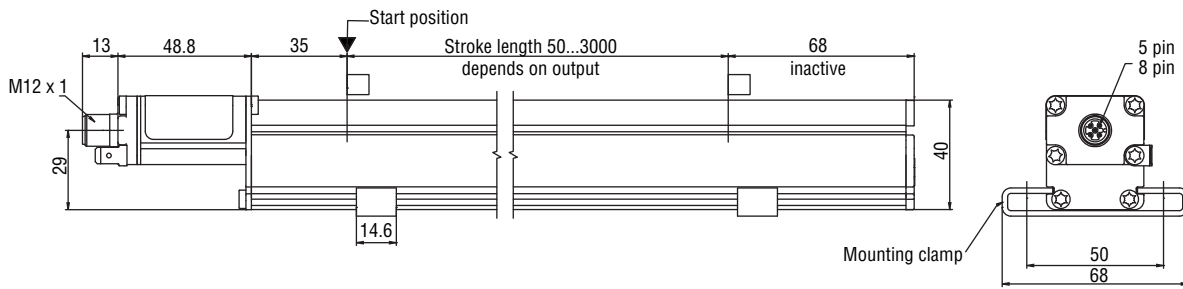

Temposonics® EL

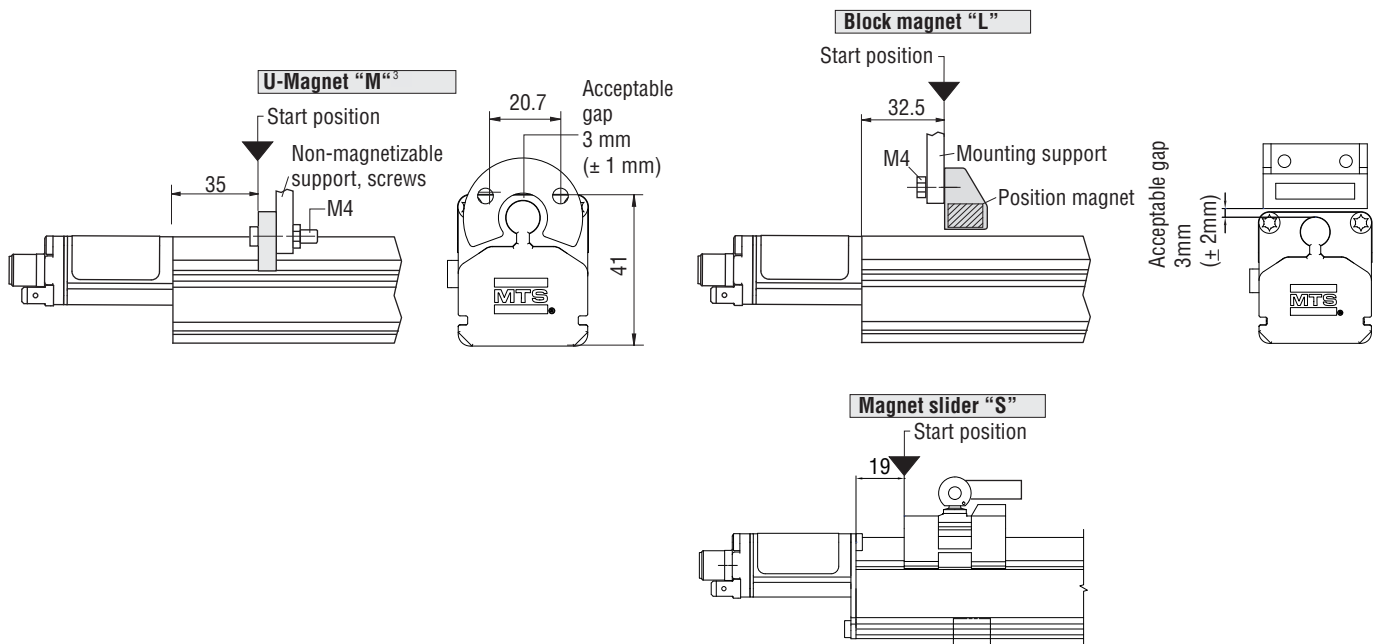
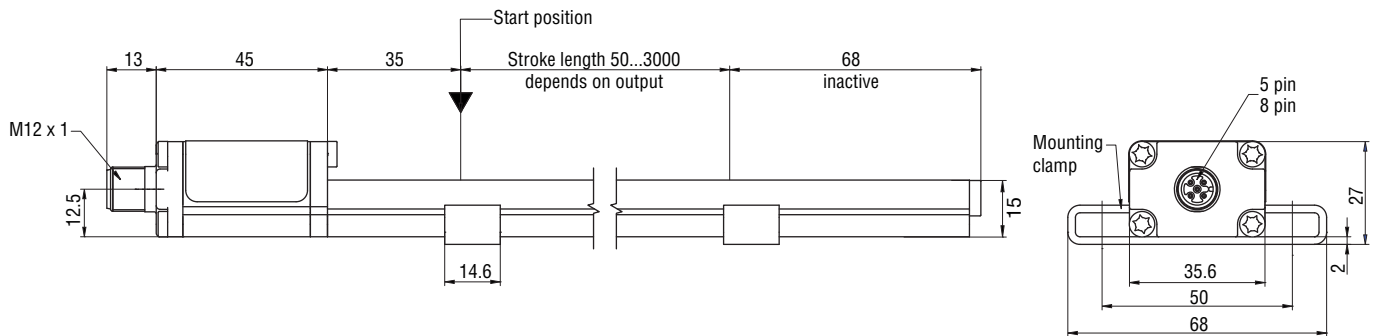

All dimensions in mm.

³ only for EP transducers

Position magnets (not included in delivery, please order separately)

Magnet slider S
Part no. 252 182

GRP, magnet hard ferrite
Joint CuZn39Pb3 nickel-plated
Weight ca. 30 g
Operating temperature: -40...+75 °C

Magnet slider V
Part no. 252 184

GRP, magnet hard ferrite
Joint CuZn39Pb3 nickel-plated
Weight ca. 30 g
Operating temperature: -40...+75 °C

U-Magnet OD33⁴
Part no. 251 416-2

PA-Ferrite-GF20
Weight ca. 11g
Operating temperature: -40...+100 °C

Block magnet L
Part no. 403 448

Magnet support: plastic
Magnet: hard ferrite
Weight: ca. 20 g
Operating temperature: -40...+75 °C

Other position magnets upon request

Connector wiring

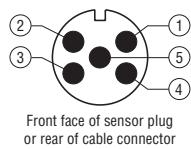

Connector D34	Analog
Pin 1	+24 VDC
Pin 2	Signal
Pin 3	GND (power supply)
Pin 4	2nd Signal
Pin 5	GND (Signal)

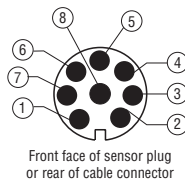

Connector D84	Start / Stop
Pin 1	Start +
Pin 2	Start -
Pin 3	Stop +
Pin 4	Stop -
Pin 5	n.c.
Pin 6	n.c.
Pin 7	+24 VDC
Pin 8	GND

Cable shield is soldered on connector housing and must be grounded in the control unit.

Connectors (not included in delivery, please order separately)

5 pin female connector M12 x 1 *

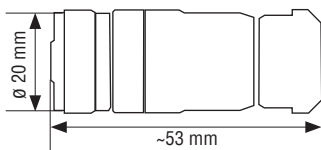

Housing: GD-Zn, Ni / IP67
Termination: screw terminals
Contact insert: CuZn
Max. cable: Ø 4...8 mm
Part no.: 370 677

5 pin 90° female connector M12 x 1 *

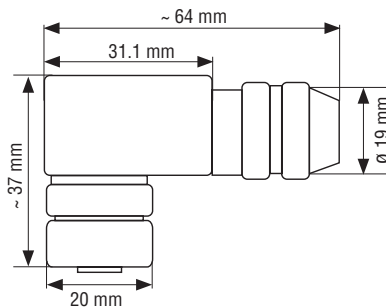

Housing: GD-Zn, Ni / IP67
Termination: screw terminals
Contact insert: CuZn
Max. cable: Ø 6...8 mm
Part no.: 370 678

8 pin female connector M12 x 1 *

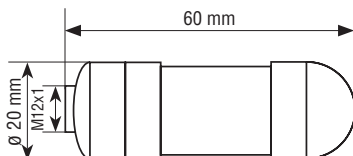

Housing: GD-ZnAL / IP67
Termination: screw terminals
Contact insert: CuZn
Max. cable: Ø 4...9 mm
Part no.: 370 694

8 pin 90° female connector M12 x 1 *

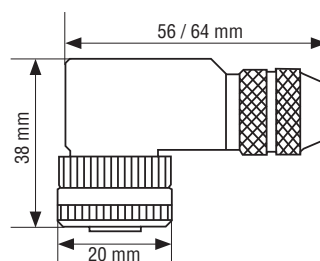

Housing: GD-ZnAL / IP67
Termination: screw terminals
Contact insert: CuZn
Max. cable: Ø 6...8 mm
Part no.: 370 699

All dimensions in mm.

⁴ only for EP transducers

* Maximum recommended torque: 0.6 Nm

Analog output

Temposonics® EP/EL is provided with an integrated analog interface and can directly be connected to a control system or indicator without an interface. The microelectronics in the sensor head generate continuous, strict position proportional voltage or current outputs whose upscale or downscale output action can be selected when ordering. The output variables are factory-setted. Recalibration is not necessary.

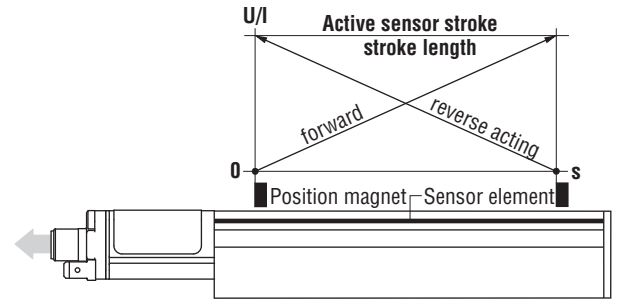

Analog

- 0...10 VDC
- 10...0 VDC
- 0...10 VDC and 10...0 VDC
- 4...20 mA
- 20...4 mA

Start/stop output

Temposonics® EP/EL is equipped with a start/stop output. The sensor requires a start signal from an external indicator in the control system and returns a signal corresponding to the magnet position. The time elapsed between the two signals is proportional to the magnet position, i.e. to the position. Time measurement is done by the indicator and used for calculating the position value.

For easy adaption to user's control systems, the following sensor parameters:

- Stroke length
- Offset
- Gradient
- Status
- Manufacturer number

can be read into controller without additional wiring. It can simply be done by using the standard signal outputs.

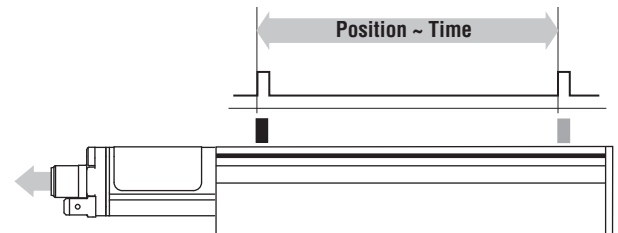
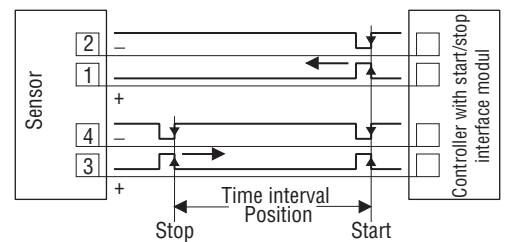

Start/Stop + parameters upload

- Stroke length
- Offset
- Gradient
- Status
- Manufacturer number

Profile

The sensor is fixed on a flat surface of the machine with the mounting clamps. The number of clamps is dependent on the length of the sensor. The clamps should be distributed evenly along the profile. We recommend M5 x 20 (DIN 6912) screws for attachment to be tightened with a torque of max. **5 Nm**.

CAUTION!

In order to use the sensor correctly the sensor housing must be grounded with a flat pin terminal (6.3 x 0.8 mm) on the sensor head **(1)**.

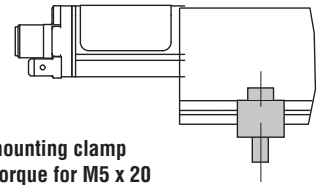
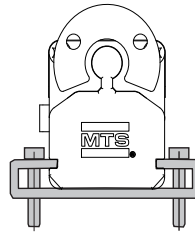

Sliding mounting clamp
Tightening torque for M5 x 20
Machine screws: max. 5 Nm

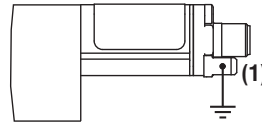

Position transmitter

U-Magnet: For accurate position measurements mount the position magnet **(1)** with non-magnetizable fastening material **(2)** (screws, supports etc.). Using magnetizable supports, note that the position magnet must be mounted with nonferrous support **(3)** of 5 mm minimum and screws.

Block magnet: The position magnet **(4)** can be fixed with standard material and screws **(5)** Note the clearance, as shown here in the diagram on the right.

CAUTION!

Take notice of permitted gap.

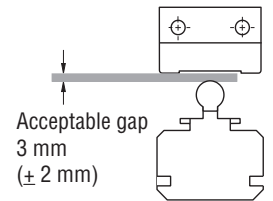
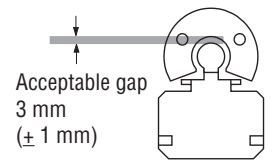
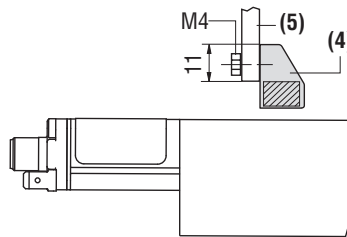
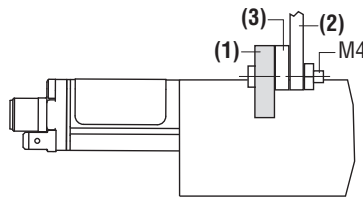

Temposonics® Ordering information



Specification

P = Temposonics® EP Sensor
L = Temposonics® EL Sensor

0 = without position magnet

Stroke length

0050...2500 mm
0050...3000 mm (output start/stop)

Connection type

D34 - 5 pin cable connector M12 (analog)
D84 - 8 pin cable connector M12 (start/stop)

Supply voltage

1 - +24 VDC

Output

Analog voltage

V01 = 0...10 VDC (1 output channel with 1 position magnet)
V11 = 10...0 VDC (1 output channel with 1 position magnet)
V02 = 0...10 VDC (2 output channels with 2 position magnets)
V12 = 10...0 VDC (2 output channels with 2 position magnets)
V03 = 0...10 VDC and 10...0 VDC (2 output channels with 1 position magnet)

Analog current

A01 = 4...20 mA (1 output channel with 1 position magnet)
A11 = 20...4 mA (1 output channel with 1 position magnet)
A02 = 4...20 mA (2 output channels with 2 position magnets)
A12 = 20...4 mA (2 output channels with 2 position magnets)

Start/Stop

R3 = Start / Stop with sensor parameters upload function.

Stroke length standard:

Stroke length	Ordering steps
≤ 500 mm	25 mm
> 500...≤ 2500 mm	50 mm
> 2500 mm...≤ 3000 mm*	100 mm

Delivery includes:

- Sensor
- 2 Mounting clamps up to 1250 mm stroke
- + 1 Mounting clamp for every 500 mm

Please order separately: accessories (see below)

Accessories

Description	Part no.
Magnet slider "S"	252 182
Magnet slider "V"	252 184
U-Magnet OD33	251 416-2
Block magnet L	403 448
Mounting clamp	403 508
5 pin female connector M12	370 677
5 pin 90° female connector M12	370 678
8 pin female connector M12	370 694
8 pin 90° female connector M12	370 699
5 pin M12 cordset, 5 m PUR shielded cable	370 673
8 pin M12 cordset, 5 m PUR shielded cable	370 674
5 pin 90° M12 cordset, 5 m PUR shielded cable	370 675
8 pin 90° M12 cordset, 5 m PUR shielded cable	370 676
Adapter cable	on request

* Only for output start/stop

Document Part Number: 551245 Revision F (EN) 06/2014

MTS and Temposonics® are registered trademarks of MTS Systems Corporation. All other trademarks are the property of their respective owners. Printed in Germany.
Copyright © 2014 MTS Sensor Technologie GmbH & Co. KG. Alterations reserved. All rights reserved in all media. No license of any intellectual property rights is granted. The information is subject to change without notice and replaces all data sheets previously supplied. The availability of components on the market is subject to considerable fluctuation and to accelerated technical progress. Therefore we reserve the right to alter certain components of our products depending on their availability. In the event that product approbations or other circumstances related to your application do not allow a change in components, a continuous supply with unaltered components must be agreed by specific contract.



**MTS Sensor Technologie GmbH
& Co. KG**
Auf dem Schüffel 9
58513 Lüdenscheid, Germany
Tel. + 49-23 51-95 87 0
Fax + 49-23 51-5 64 91
E-Mail: info.de@mtssensors.com
www.mtssensors.com

MTS Systems Corporation
Sensors Division
3001 Sheldon Drive
Cary, N.C. 27513, USA
Tel. + 1-919-677-0100
Fax + 1-919-677-0200
E-Mail: info.us@mtssensors.com
www.mtssensors.com

MTS Sensors Technology Corp.
737 Aihara-cho,
Machida-shi, Japan
Tel. + 81-42-775-3838
Fax + 81-42-775-5516
E-Mail: info.jp@mtssensors.com
www.mtssensors.com