

BSI Q41K0-XA-MYS090-S92 BSI0014

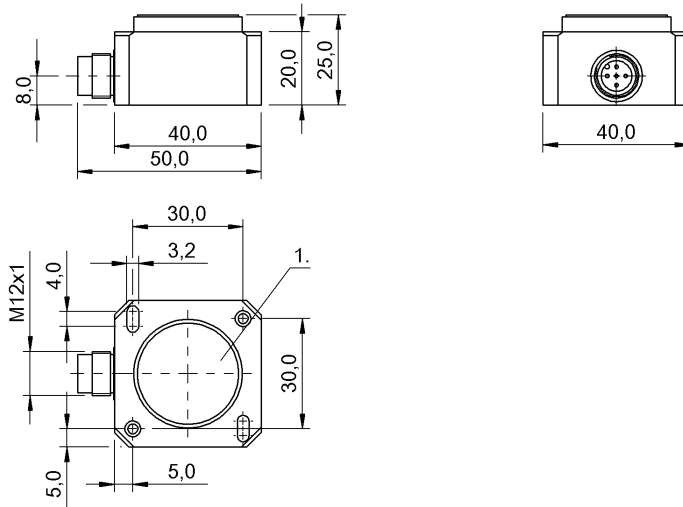

Electrical connection

Connection	M12x1
Polarity reversal protected	yes
Short-circuit protection	yes

Electrical data

Current draw max.	15 mA
Load resistance min., analog output	20 kOhm
MTTF (40 °C)	263 a
Operating voltage U_b	12...30 VDC
Pollution degree	3
Protected against miswiring	yes
Rated operating voltage U_e DC	24 V
Ready delay t_v max.	1 s

Environmental conditions

Ambient temperature	-25...85 °C
EN 60068-2-27, Shock	yes
EN 60068-2-6, Vibration	yes
Protection class	III
Protection type IEC 60529	IP67
Relative humidity	95 %, non-condensing
Storage temperature	-40...85 °C

General data

Approval/Conformity	CE cULus
---------------------	-------------

Basic standard	EN 61326-1
Measuring principle	MEMS

Material

Housing material	Plastic
------------------	---------

Mechanical data

Measuring axes	2
Rotation direction	Clockwise
Weight	45.00 g

Output/Interface

Analog inputs	(0...10 V)
Analog output	Analog, voltage, 0...10 V Analog, voltage

Range/Distance

Accuracy	$\pm 0.8^\circ$
Resolution	$\leq 0.09^\circ$
Sampling rate	20 ms
Temperature drift max.	$\pm 0.8^\circ/10\text{ K}$

For further information on MTTF/B10d, please refer to the MTTF / B10d Certificate.

Specification of the MTTF value and the B10d value do not represent any binding quality and/or life expectancy guarantees.

BSI Q41K0-XA-MYS090-S92
BSI0014

Connector view

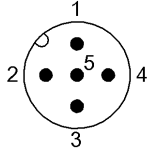

PIN 1: Vcc PIN 2: Y 0..10 V PIN 3: GND PIN 4: X
0..10 V PIN 5: Centering

Diagram

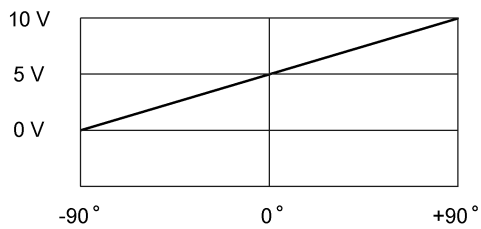

Additional View

