

## BSI R65K0-XB-MYS030-S115 BSI0007

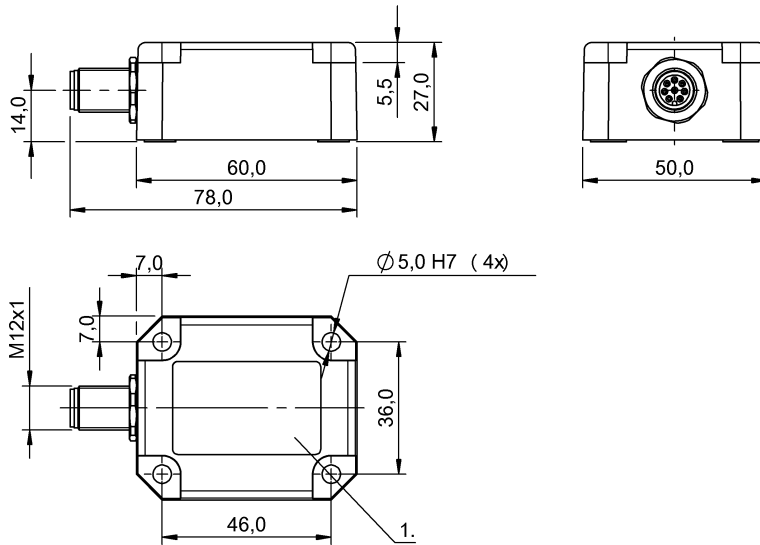

### Electrical connection

Connection	M12x1
Polarity reversal protected	yes
Short-circuit protection	yes

### Electrical data

Current draw max.	25 mA
Load resistance max., analog output	900 Ohm
MTTF (40 °C)	121 a
Operating voltage $U_b$	10...30 VDC
Pollution degree	3
Protected against miswiring	yes
Rated operating voltage $U_e$ DC	24 V
Ready delay $t_v$ max.	1 s

### Environmental conditions

Ambient temperature	-40...85 °C
EN 60068-2-27, Shock	yes
EN 60068-2-6, Vibration	yes
Protection class	III
Protection type IEC 60529	IP67
Relative humidity	95 %, non-condensing
Storage temperature	-40...85 °C

### General data

Approval/Conformity	CE cULus
---------------------	-------------

Basic standard	EN 61326-1
Measuring principle	MEMS

### Material

Housing material	Plastic
------------------	---------

### Mechanical data

Measuring axes	2
Rotation direction	Clockwise
Weight	110.00 g

### Output/Interface

Analog inputs	(4...20 mA)
Analog output	Analog, current, 4...20 mA Analog, current

### Range/Distance

Accuracy	$\pm 0.12^\circ$
Resolution	$\leq 0.01^\circ$
Sampling rate	20 ms
Temperature drift max.	$\pm 0.1^\circ/10\text{ K}$

For further information on MTTF/B10d, please refer to the MTTF / B10d Certificate.

Specification of the MTTF value and the B10d value do not represent any binding quality and/or life expectancy guarantees.

BSI R65K0-XB-MYS030-S115  
BSI0007

## Connector view

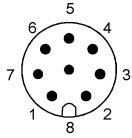

PIN 1: Y 4..20 mA PIN 2: Vcc PIN 3: Int. use PIN 4:  
Int. use PIN 5: GND PIN 6: Centering PIN 7: 4..20  
mA PIN 8: Shield

## Diagram

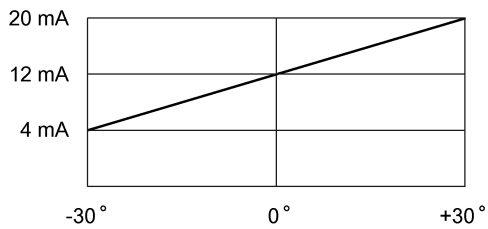

## Additional View

