



**Model Number**

**RL61-8-4000-Z/92/136**

Diffuse mode sensor  
with 4-pin, M12 x 1 connector

**Features**

- Cost-optimized series for standard tasks in a special design
- Compact design
- Wide range of mounting options thanks to cubic housing design with M30 thread
- 360° high visibility LEDs
- Programmable ON-delay, OFF-delay, and One-shot timers
- 4-in-1 output (push-pull)

**Product information**

The Series 61 sensor family is a comprehensive product line, offering five sensing modes. Each sensor is equipped with four LEDs that are highly visible from all directions, indicating Power-On, target presence and marginal excess gain. The widely recognized, polycarbonate housing provides a IP67 protection degree rating. Color-coded labels are clearly printed on the housing to easily identify the sensing mode. DC models offer a 4-in-1 output while AC/DC models have a SPDT relay output rated to 3 A. All versions come standard with an integral multifunction timer, sensitivity adjustment and Light-ON/Dark-ON switch. Series 61 sensors are cross-talk protected and have a high degree of resistance to ambient lighting. Each sensor can be mounted via front and rear slots, rear dovetail guide or M30 x 1.5 mounting base. Additionally, cabled sensor models provide 1/2" - 14 NPT internal threads for use with flexible conduit.

**Dimensions**

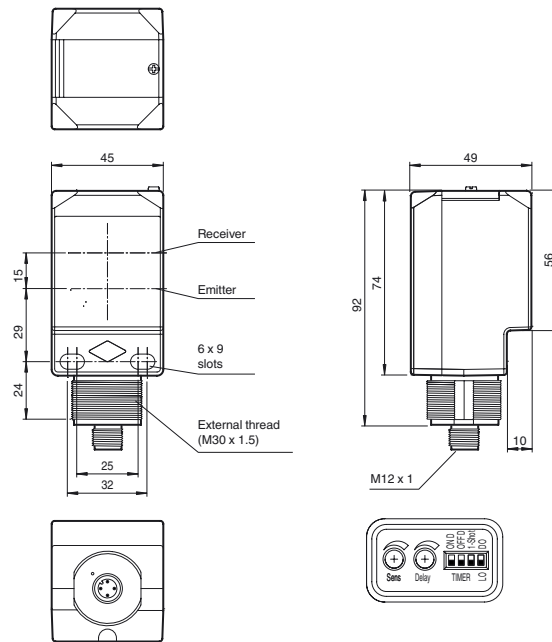

**Electrical connection**

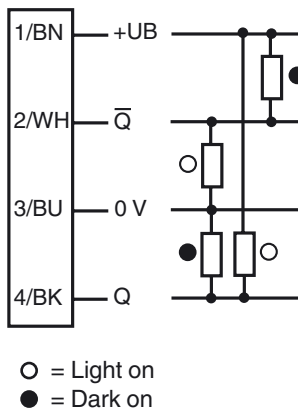

**Pinout**

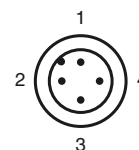

**Indicators/operating means**

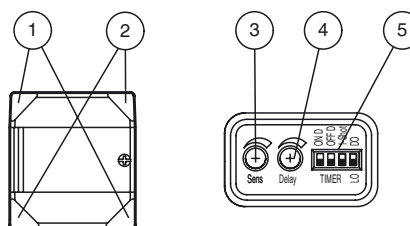

1	Operating display	green
2	Signal display	yellow
3	Sensing range adjuster	
4	Time adjuster	
5	DIP-switches	

Release date: 2014-10-30 13:11 Date of issue: 2014-10-30 911614\_eng.xml

Refer to "General Notes Relating to Pepperl+Fuchs Product Information".

Pepperl+Fuchs Group  
www.pepperl-fuchs.com

USA: +1 330 486 0001  
fa-info@us.pepperl-fuchs.com

Germany: +49 621 776 4411  
fa-info@de.pepperl-fuchs.com

Singapore: +65 6779 9091  
fa-info@sg.pepperl-fuchs.com

**Technical data****General specifications**

Detection range	0 ... 4000 mm adjustable
Adjustment range	270 ... 4000 mm
Reference target	standard white 200 mm x 200 mm
Light source	IREL
Light type	modulated infrared light , 850 nm
Diameter of the light spot	approx. 45 mm at a distance of 4000 mm
Angle of divergence	0.7 °
Ambient light limit	5000 Lux ; according EN 60947-5-2

**Indicators/operating means**

Operation indicator	2 LEDs green
Function indicator	2 LEDs yellow ON: object inside the sensing range OFF: object outside the sensing range
Control elements	Light/Dark switch
Control elements	Detection range adjuster
Control elements	Time adjuster ( 0 ... 50 ms )

**Electrical specifications**

Operating voltage	$U_B$	10 ... 30 V DC
Ripple		10 %
No-load supply current	$I_0$	≤ 35 mA
Protection class		II , rated voltage ≤ 250 V AC with pollution degree 1-2 according to IEC 60664-1 Output circuit basis insulation of input circuit according to EN 50178, rated insulation voltage 240 V AC

**Output**

Switching type	light/dark on, switchable	
Signal output	2 push-pull (4 in 1) outputs, short-circuit protected, reverse polarity protected	
Switching voltage	max. 30 V DC	
Switching current	max. 100 mA	
Voltage drop	$U_d$	≤ 2.5 V
Switching frequency	$f$	500 Hz
Response time		≤ 1 ms
Timer function		DIP-switch for selection of operating modes

**Ambient conditions**

Ambient temperature	-40 ... 55 °C (-40 ... 131 °F)
Storage temperature	-40 ... 70 °C (-40 ... 158 °F)

**Mechanical specifications**

Degree of protection	IP67
Connection	4-pin, M12 x 1 connector
Material	
Housing	PC (Polycarbonate)
Optical face	PMMA
Mass	120 g
Tightening torque, fastening screws	≤ 2 Nm

**Compliance with standards and directives**

Standard conformity	
Product standard	EN 60947-5-2:2007 IEC 60947-5-2:2007

**Approvals and certificates**

UL approval	cULus
CCC approval	CCC approval / marking not required for products rated ≤36 V

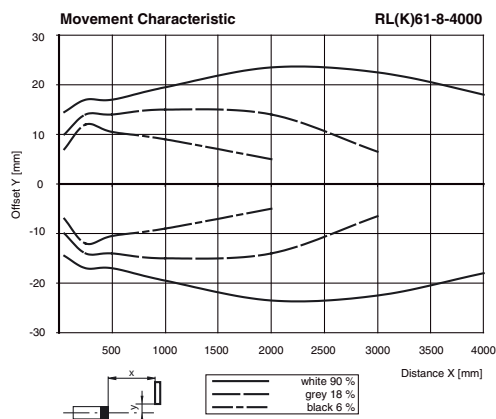
**Curves/Diagrams****Accessories****MPZB01**

Mounting bracket with vertical slots

**MPZB02**

Mounting bracket with circular slots

**MPZB06**

Ball and Swivel Mounting Bracket

**MPZB07**

Ball and Swivel Vertical Mounting Plate

**V1-G-2M-PUR**

Female cordset, M12, 4-pin, PUR cable

**V1-W-2M-PUR**

Female cordset, M12, 4-pin, PUR cable

Other suitable accessories can be found at [www.pepperl-fuchs.com](http://www.pepperl-fuchs.com)

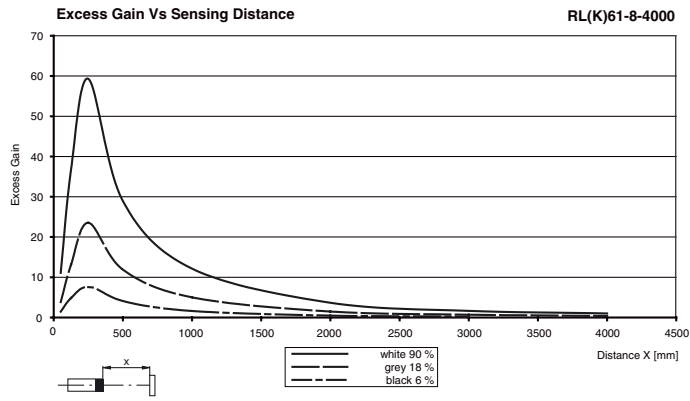

Release date: 2014-10-30 13:11 Date of issue: 2014-10-30 911614\_eng.xml

Refer to "General Notes Relating to Pepperl+Fuchs Product Information".

Pepperl+Fuchs Group  
www.pepperl-fuchs.com

USA: +1 330 486 0001  
fa-info@us.pepperl-fuchs.com

Germany: +49 621 776 4411  
fa-info@de.pepperl-fuchs.com

Singapore: +65 6779 9091  
fa-info@sg.pepperl-fuchs.com

Timer Functions

Switching Type	Detection Status	Light Received	No Light Received
<b>L.ON</b> Operation Mode			
OFF ON  Timer LO	No Delay (Timer OFF)	ON	OFF
OFF ON  Timer LO	ON Delay	ON	OFF
OFF ON  Timer LO	OFF Delay	ON	OFF
OFF ON  Timer LO	One-Shot Delay	ON	OFF
OFF ON  Timer LO	ON Delay and OFF Delay	ON	OFF
<b>D.ON</b> Operation Mode			
OFF ON  Timer LO	No Delay (Timer OFF)	ON	OFF
OFF ON  Timer LO	ON Delay	ON	OFF
OFF ON  Timer LO	OFF Delay	ON	OFF
OFF ON  Timer LO	One-Shot Delay	ON	OFF
OFF ON  Timer LO	ON Delay and OFF Delay	ON	OFF

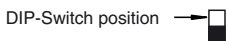

Time (T) is adjustable from 0 to 50 ms

Release date: 2014-10-30 13:11 Date of issue: 2014-10-30 911614\_eng.xml

## Adjustment Instructions

**Intended use:**

The diffuse mode sensor contains the emitter and receiver in a single housing. The light from transmitter is reflected back from the target object and is evaluated by the receiver. The sensing range depends on the object color and finish. With dark or very small objects, the sensing range is reduced.

**Mounting instructions:**

The sensor can be mounted using the through-holes or with a mounting bracket (not included with delivery). The base surface must be flat to avoid distorting the sensor housing during mounting. It is advisable to secure the bolts and screws with washers so that the sensor does not become misaligned.

**Adjustment Instructions:**

Adjust the sensor on the background. If the yellow LED illuminates, reduce the sensing range using the potentiometer until the yellow LED turns off.

**Object detection:**

Move the target into the light beam. Position the light spot on the object. If the object is detected, the yellow LED lights up. If it does not light up, further adjust the sensing range with the potentiometer until the yellow LED lights up.

**Cleaning:**

We recommend that you clean the optical interfaces and check all connections at regular intervals.